

 **GG-L1-Q2 3 m x 3 m**



12/2025-01

TOOLPORT

 **GG-L1-Q2 3 m x 3 m**

A

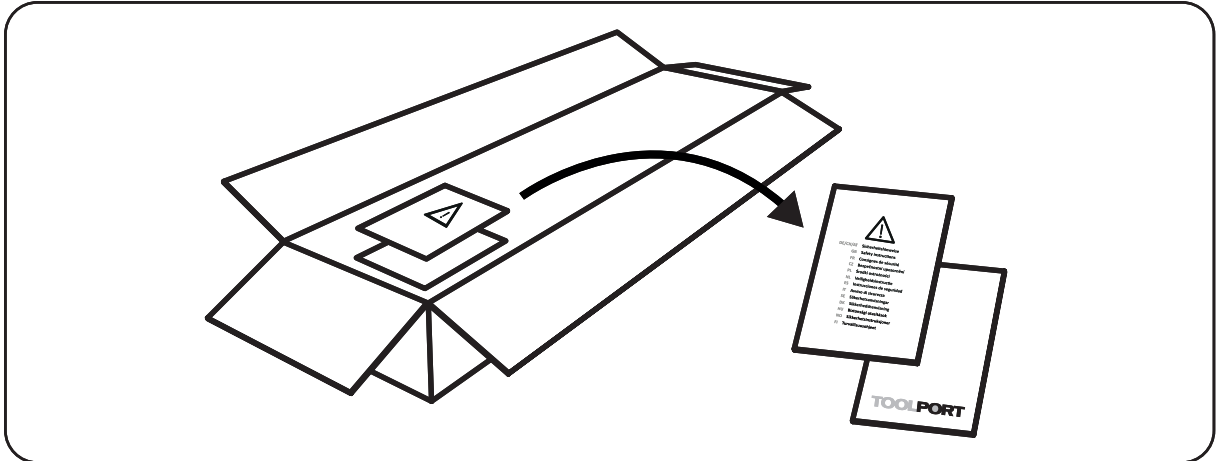



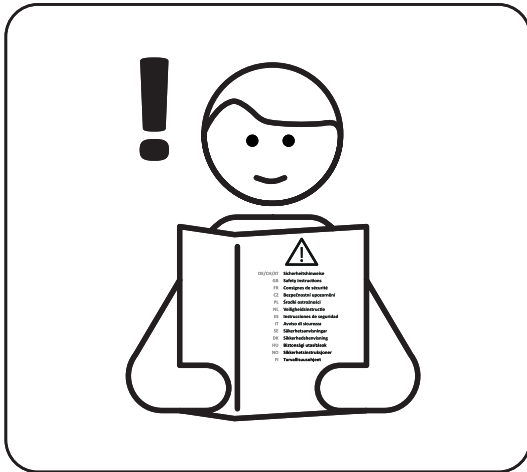



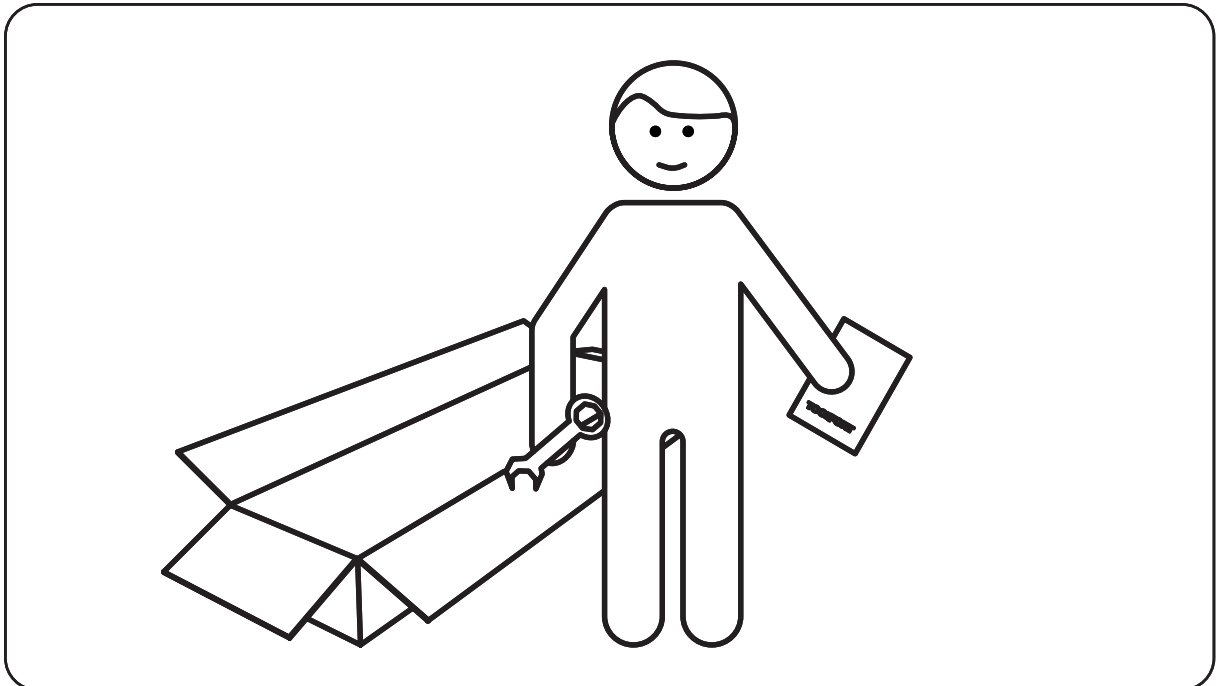



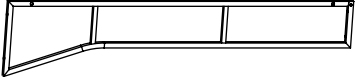
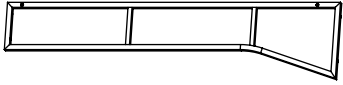

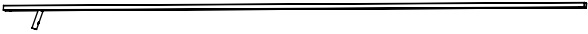
B









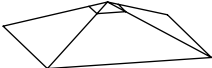

C

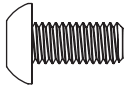

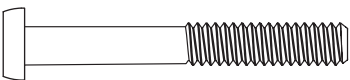
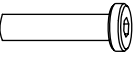
 **GG-L1-Q2 3 m x 3 m**

Item no.	ID		Q'ty
50562	A1		4
50563	B1		4
50564	B2		4
38327	C1		16
38329	D1		4
38330	D2		4
38331	D4		4
50572	E1		1
50576	F1		4
38332	G1		16
38333	G2		4
38334	H1		80+4
	J1		1
	J2		1
	K1		1

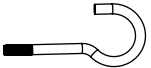
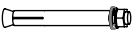
 **GG-L1-Q2 3 m x 3 m**

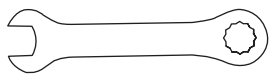
Item no.	ID		Q'ty
38335	1	M6 x 15 mm 	4+1
38336	2	M6 x 30 mm 	16+1
38337	3	M6 x 65 mm 	16+1
38338	4		8+1
38339	5		8+1
38340	6		16+1
38341	7		16+1
38342	8		1
38343	9		8
38344	10		2
38345	11		1

 **GG-L1-Q2 3 m x 3 m**

1

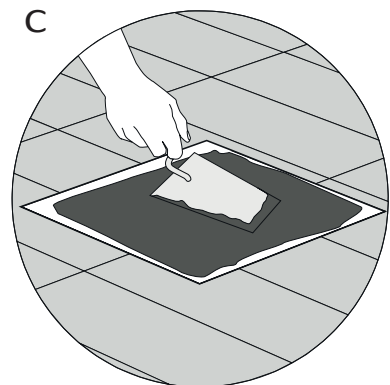
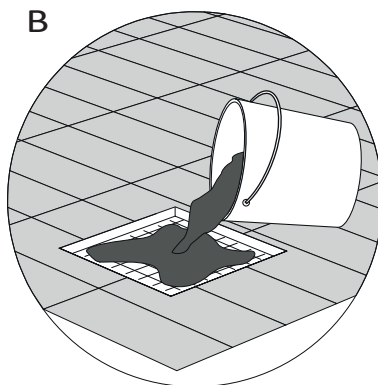
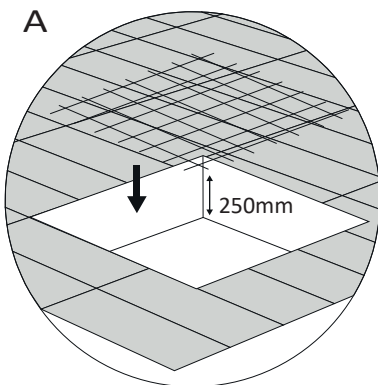
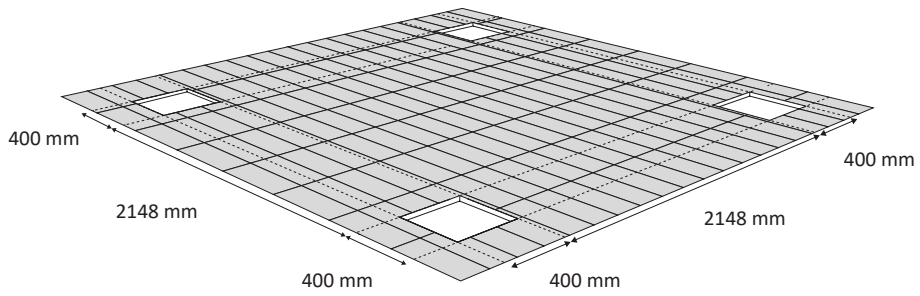
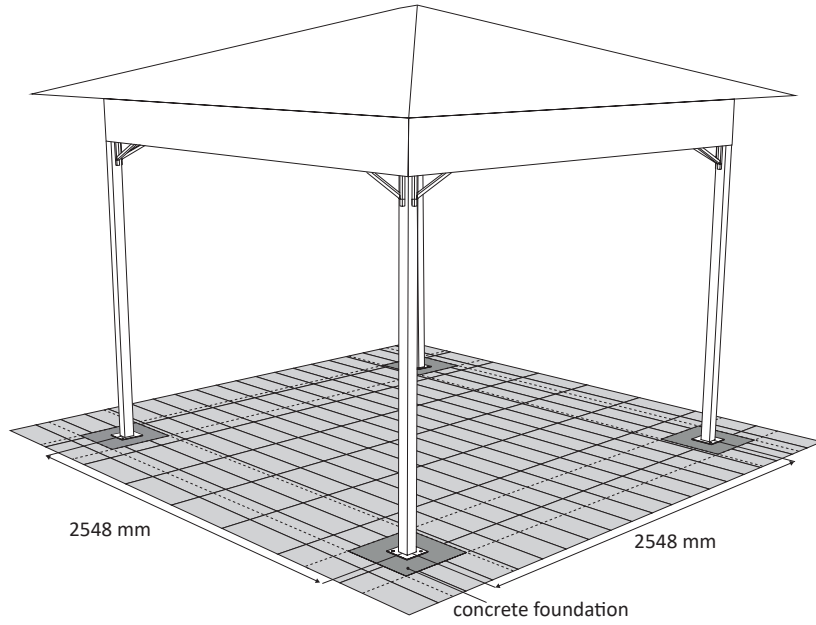

 **GG-L1-Q2 3 m x 3 m**

2

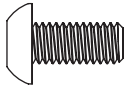

38335



50562



50576

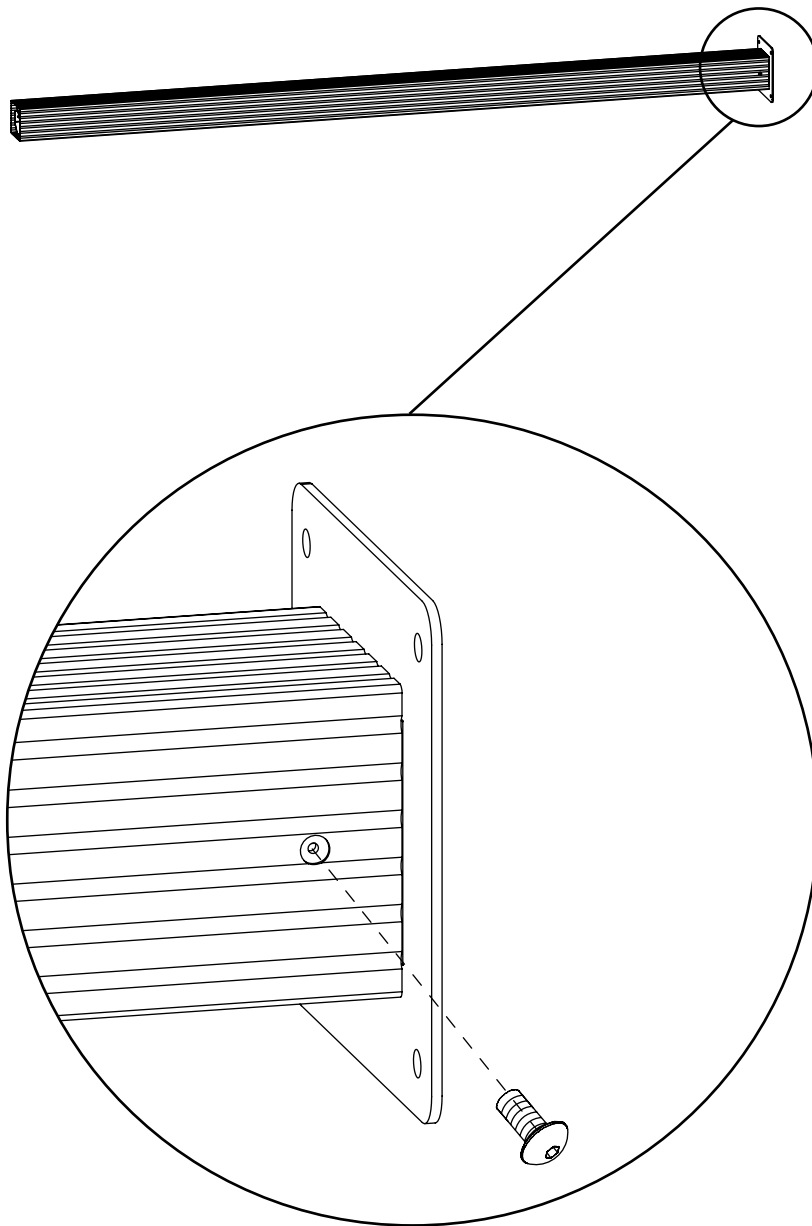

 **GG-L1-Q2 3 m x 3 m**

3

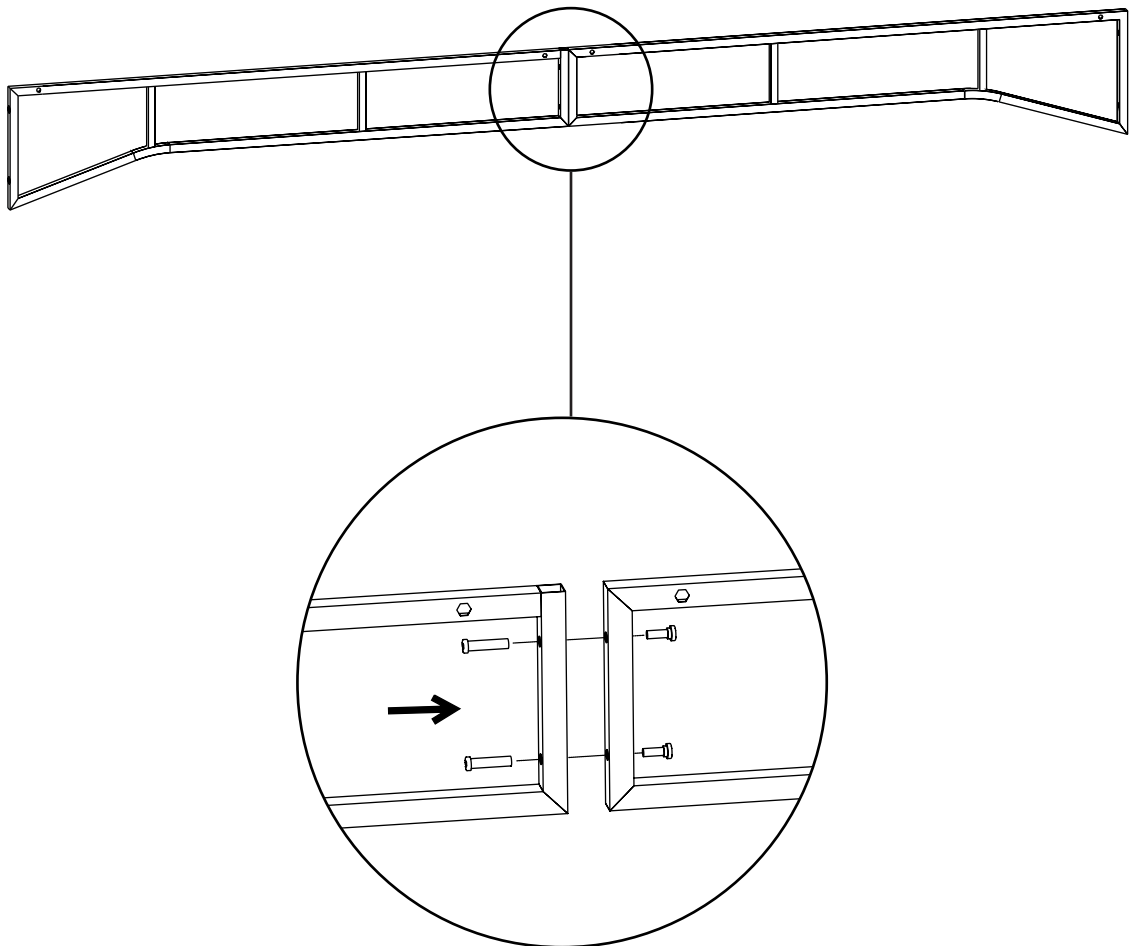
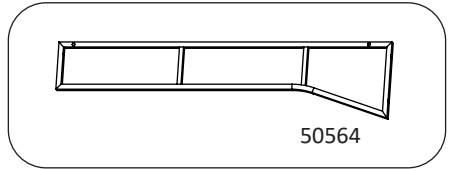
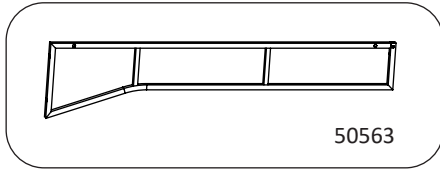
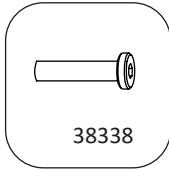

 **GG-L1-Q2 3 m x 3 m**

4

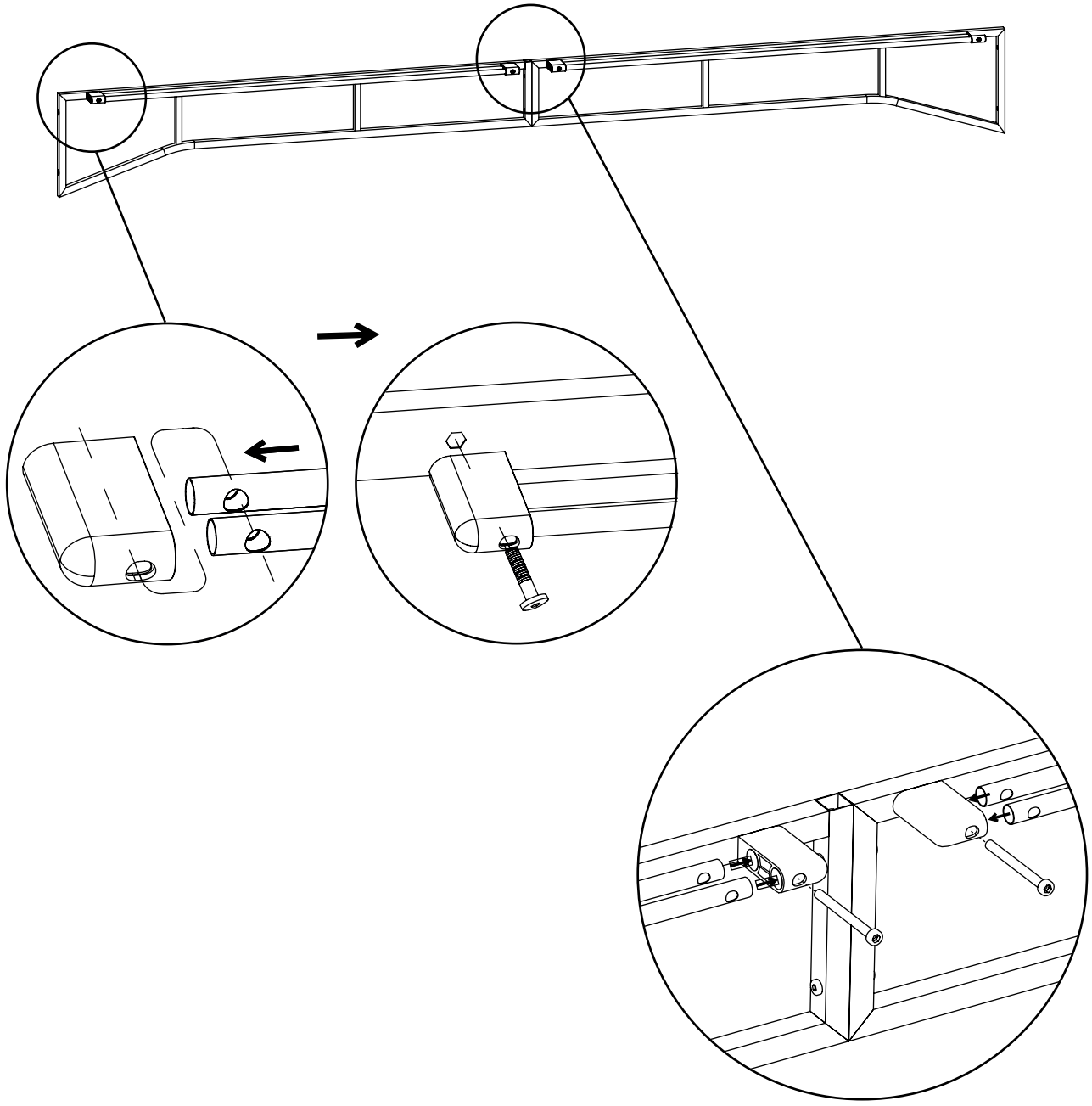
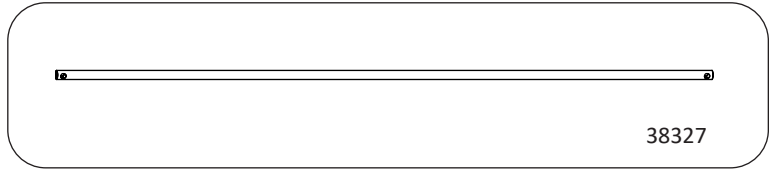
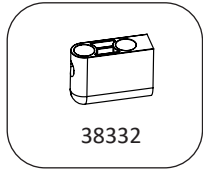
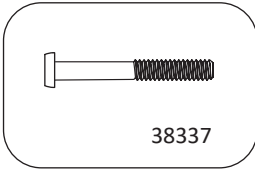

 **GG-L1-Q2 3 m x 3 m**

5

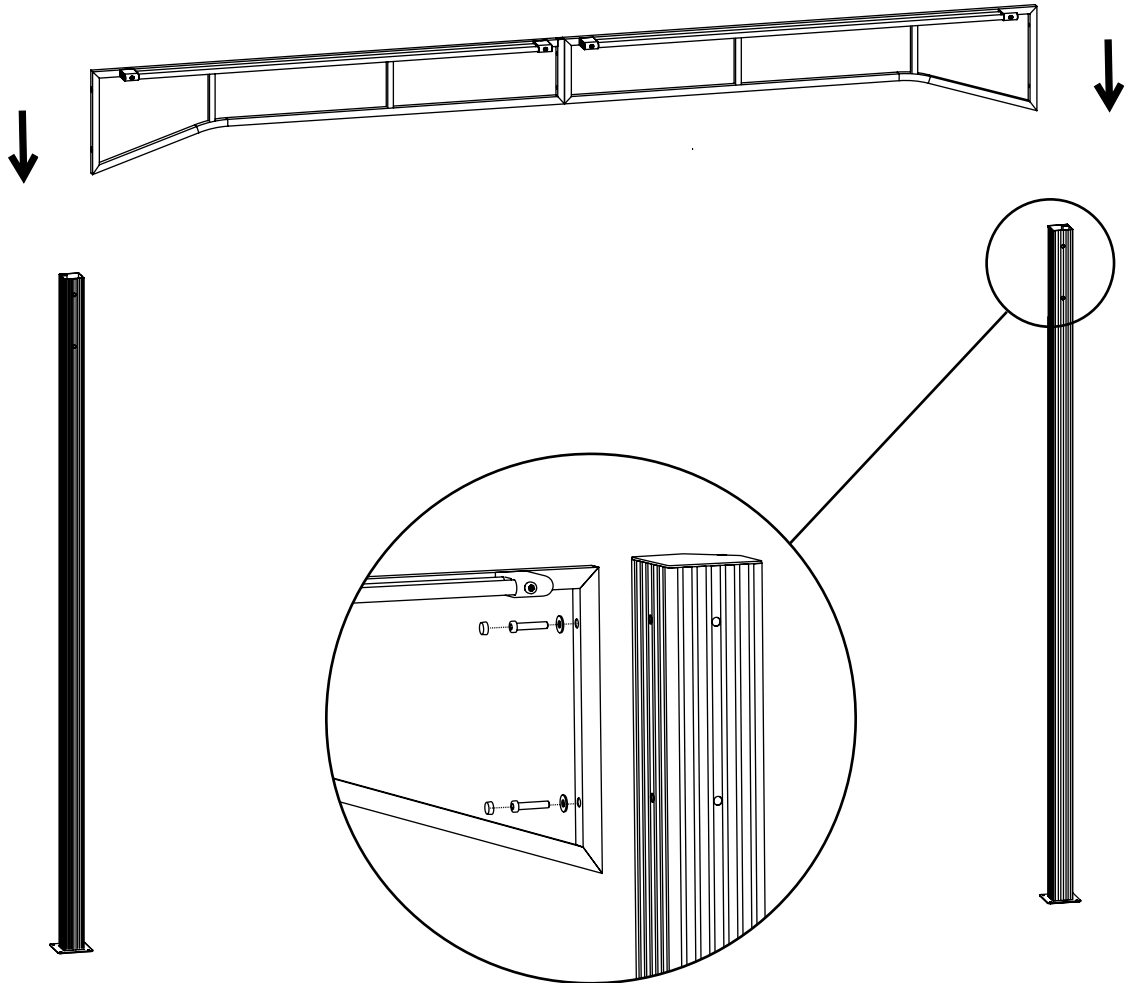
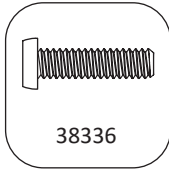

 **GG-L1-Q2 3 m x 3 m**

6

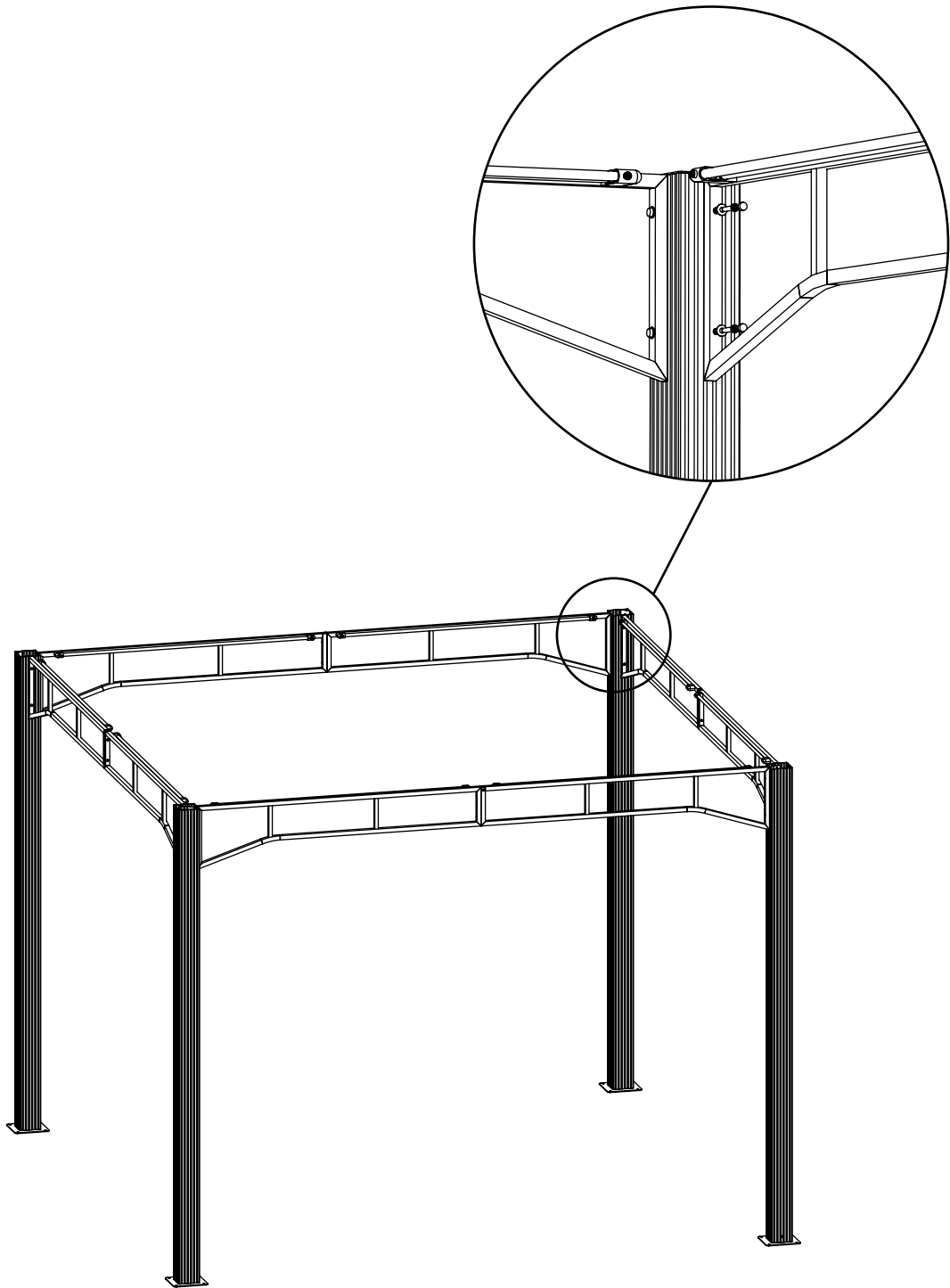
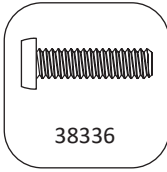

 **GG-L1-Q2 3 m x 3 m**

7

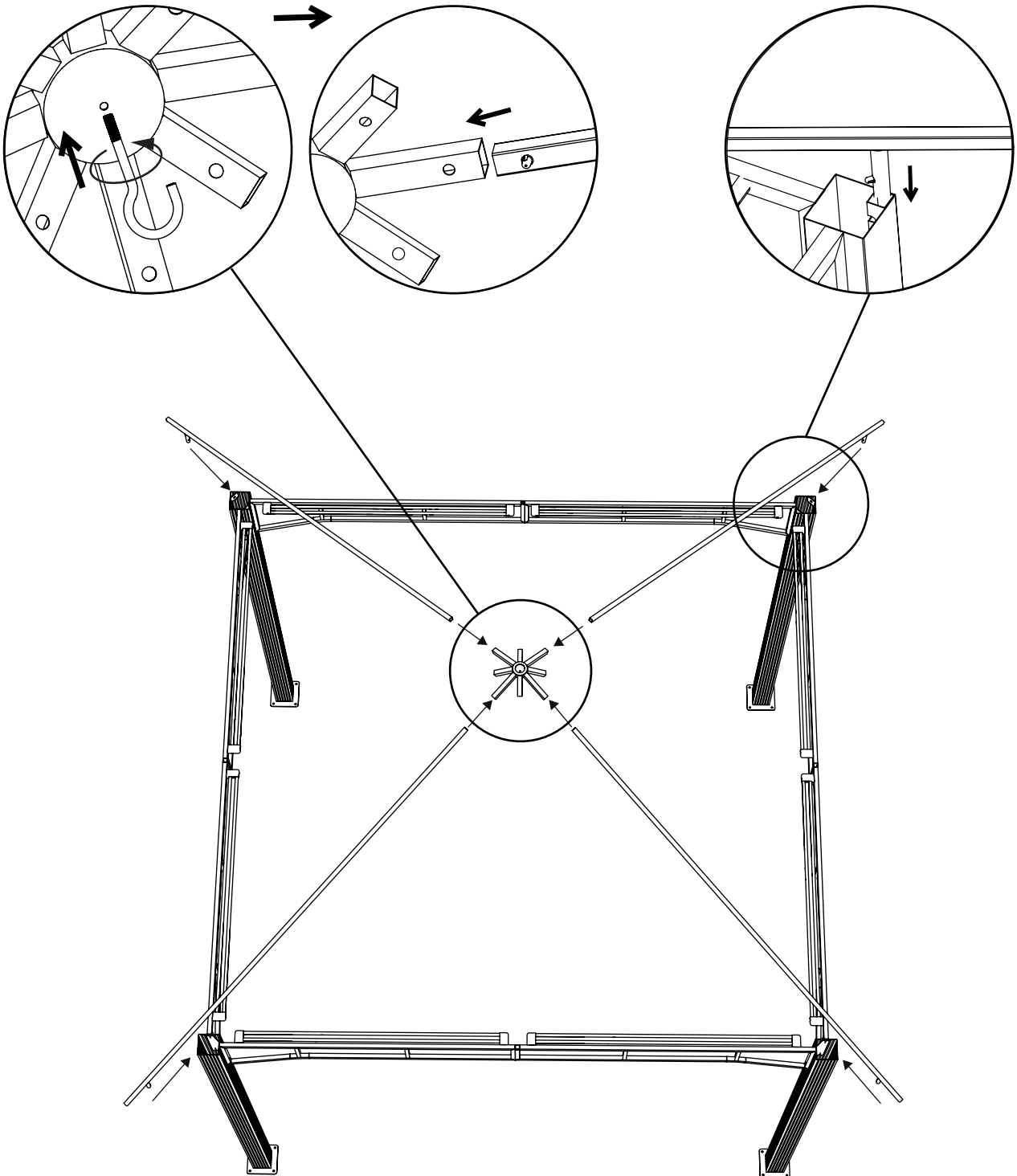
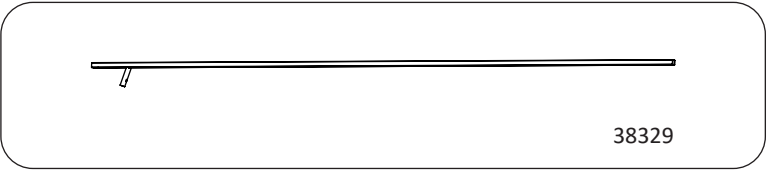
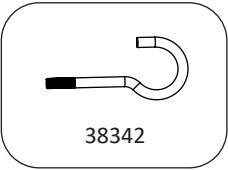
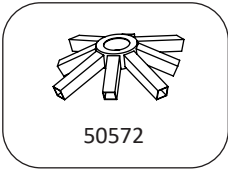

 **GG-L1-Q2 3 m x 3 m**

8

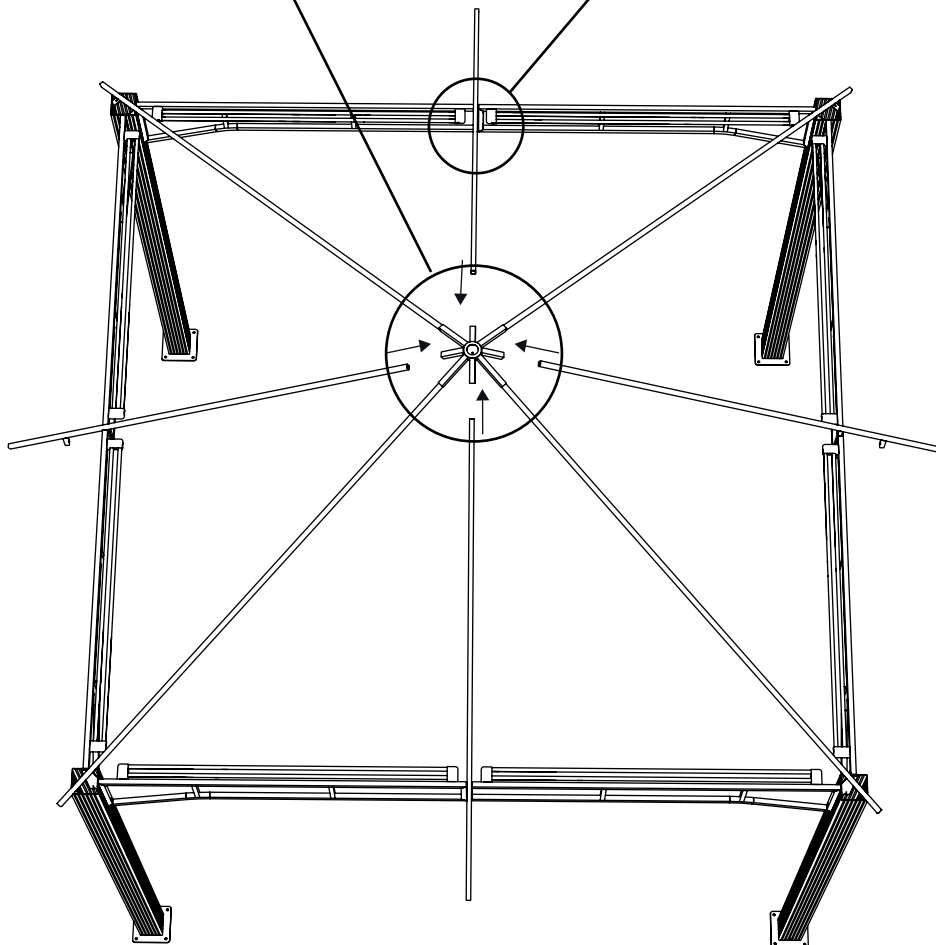
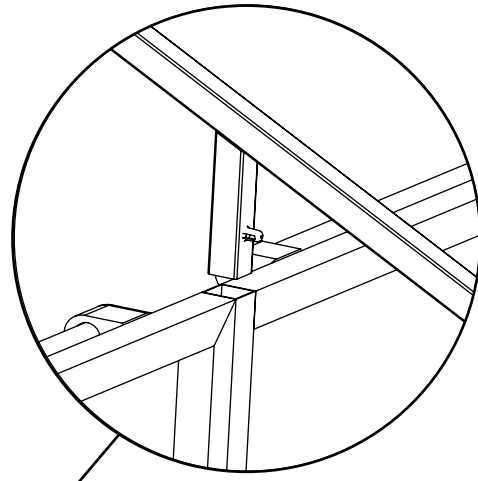
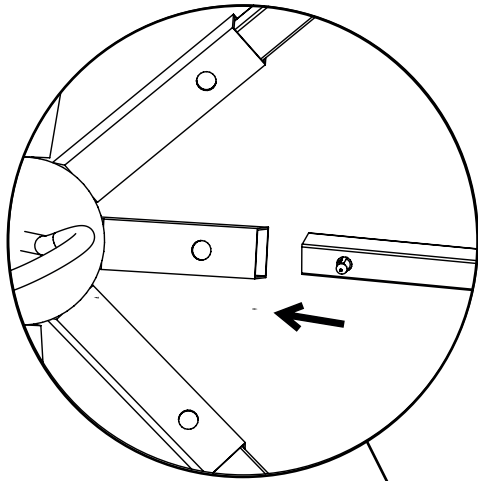
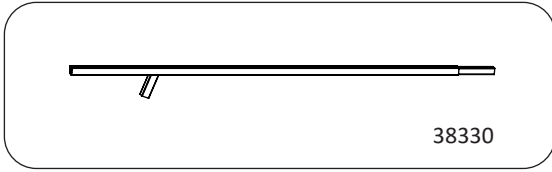

 **GG-L1-Q2 3 m x 3 m**

9

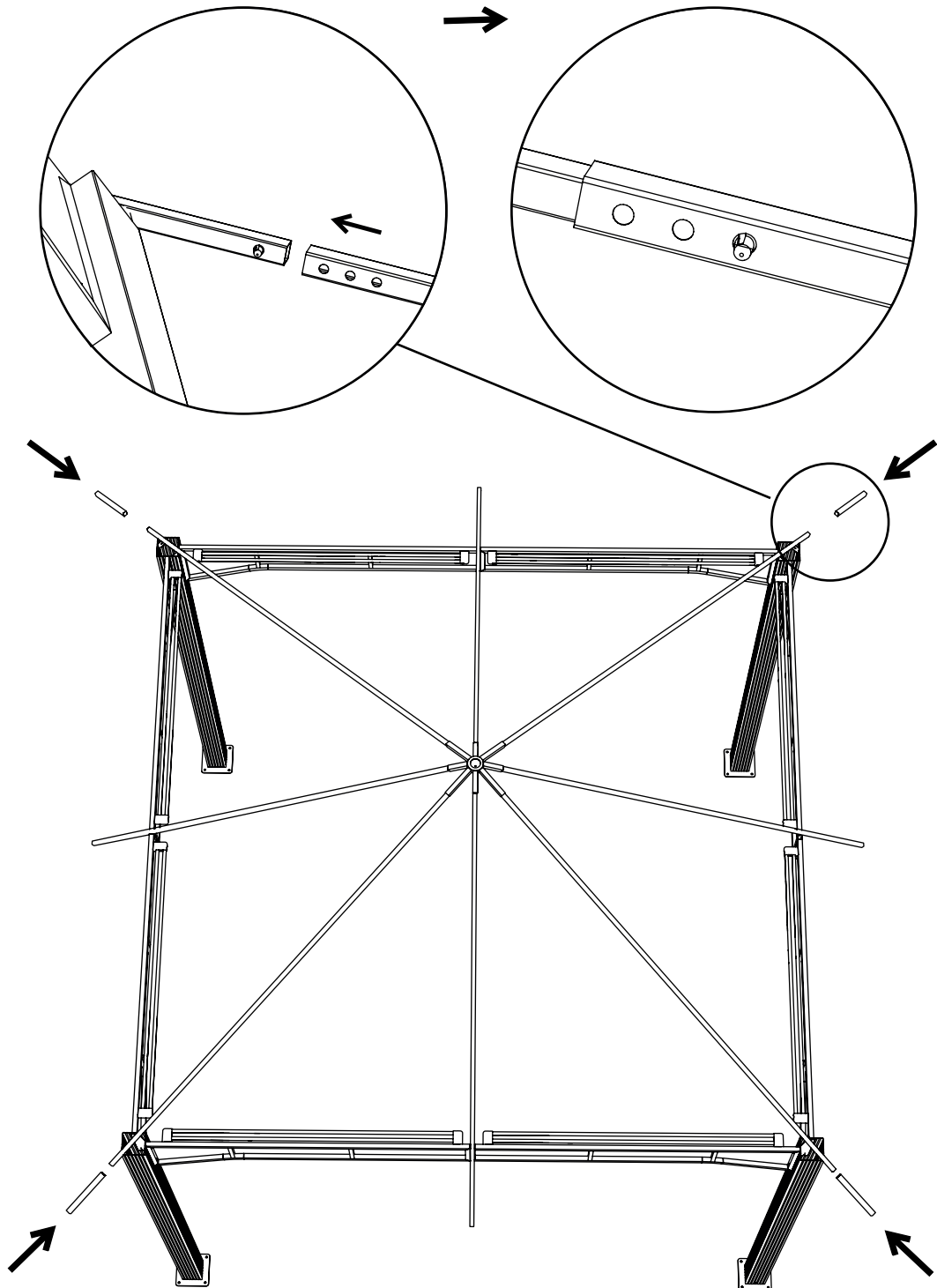
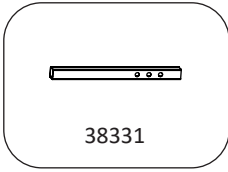

 **GG-L1-Q2 3 m x 3 m**

10

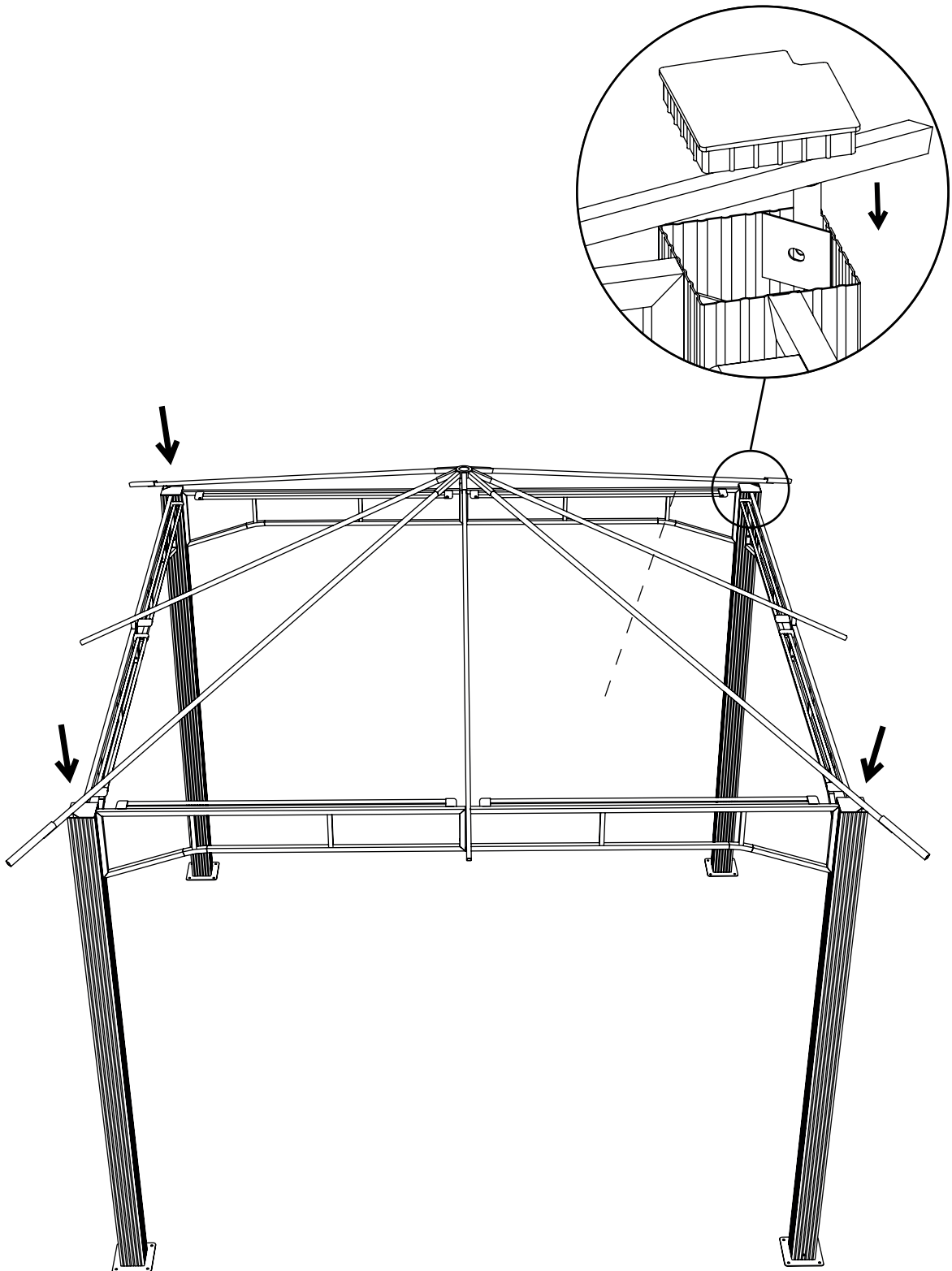

 **GG-L1-Q2 3 m x 3 m**

11

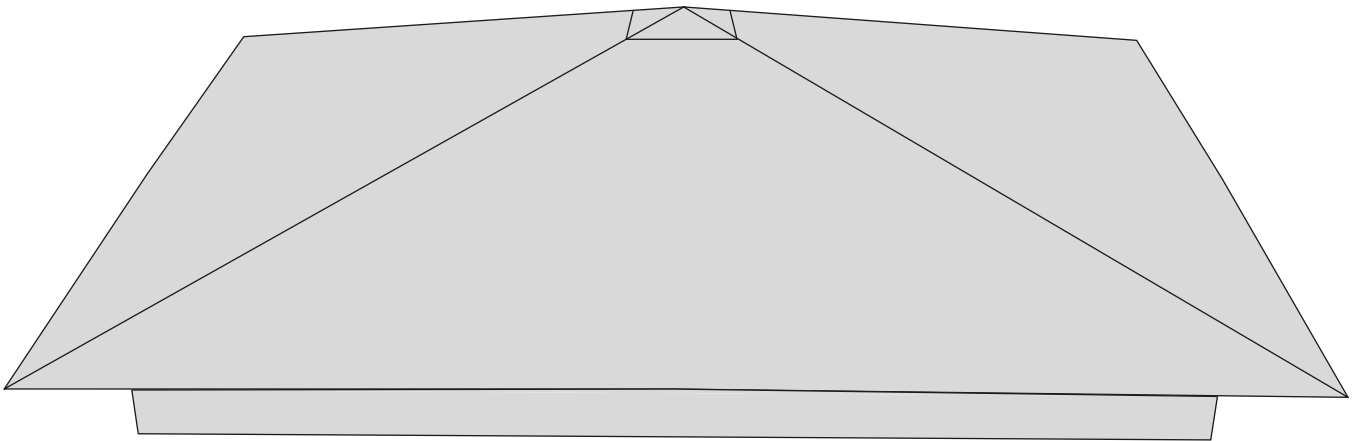
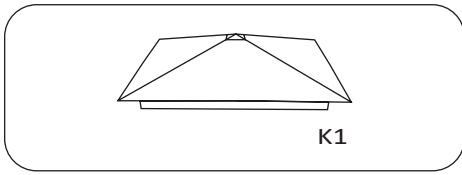

 **GG-L1-Q2 3 m x 3 m**

12

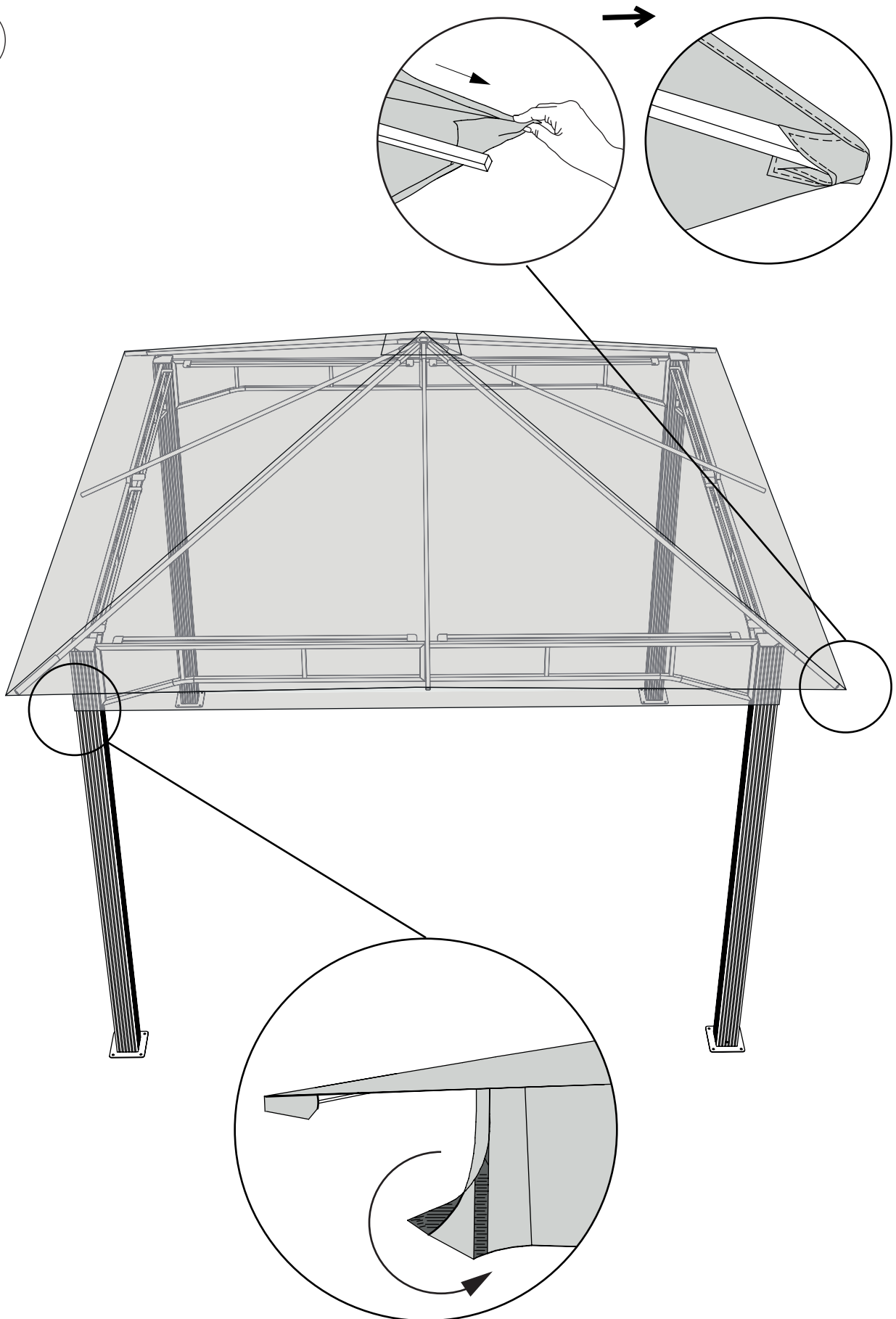

 **GG-L1-Q2 3 m x 3 m**

13

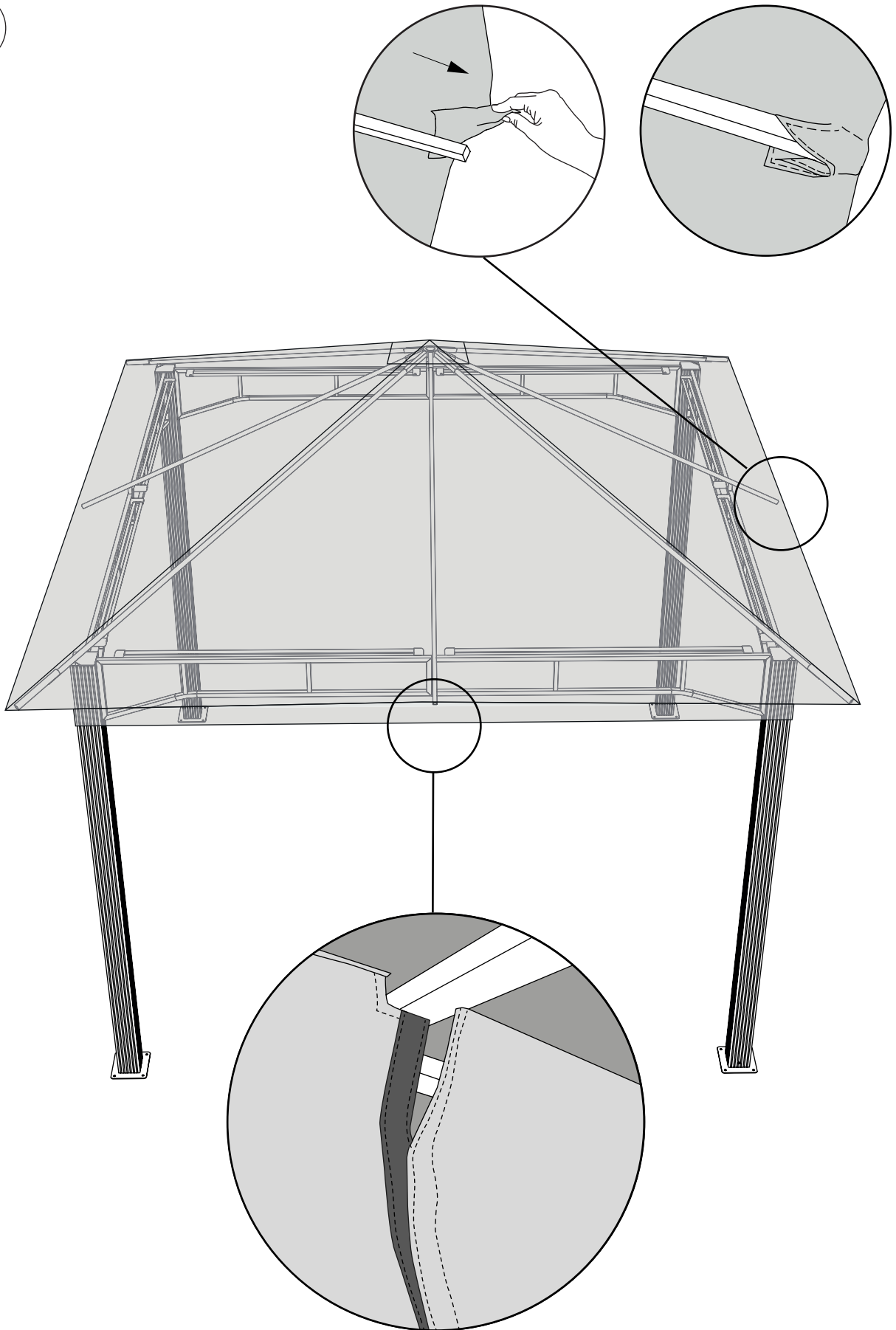

 **GG-L1-Q2 3 m x 3 m**

14

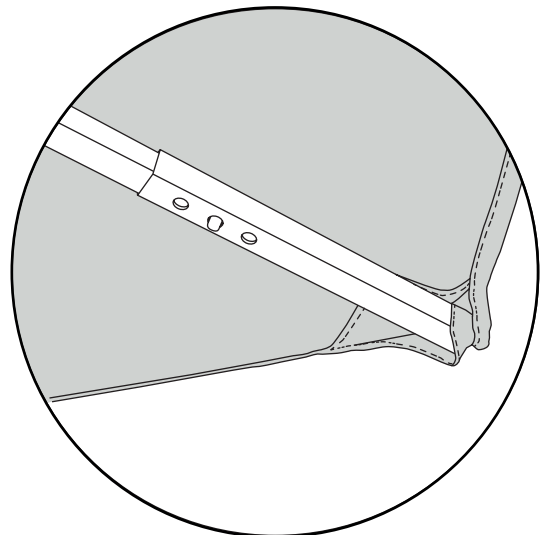
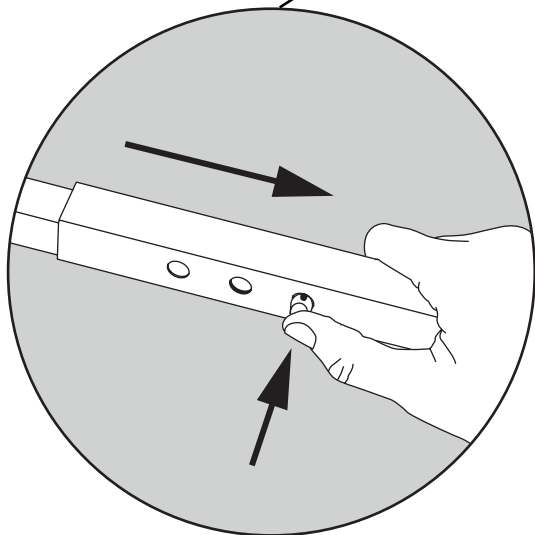
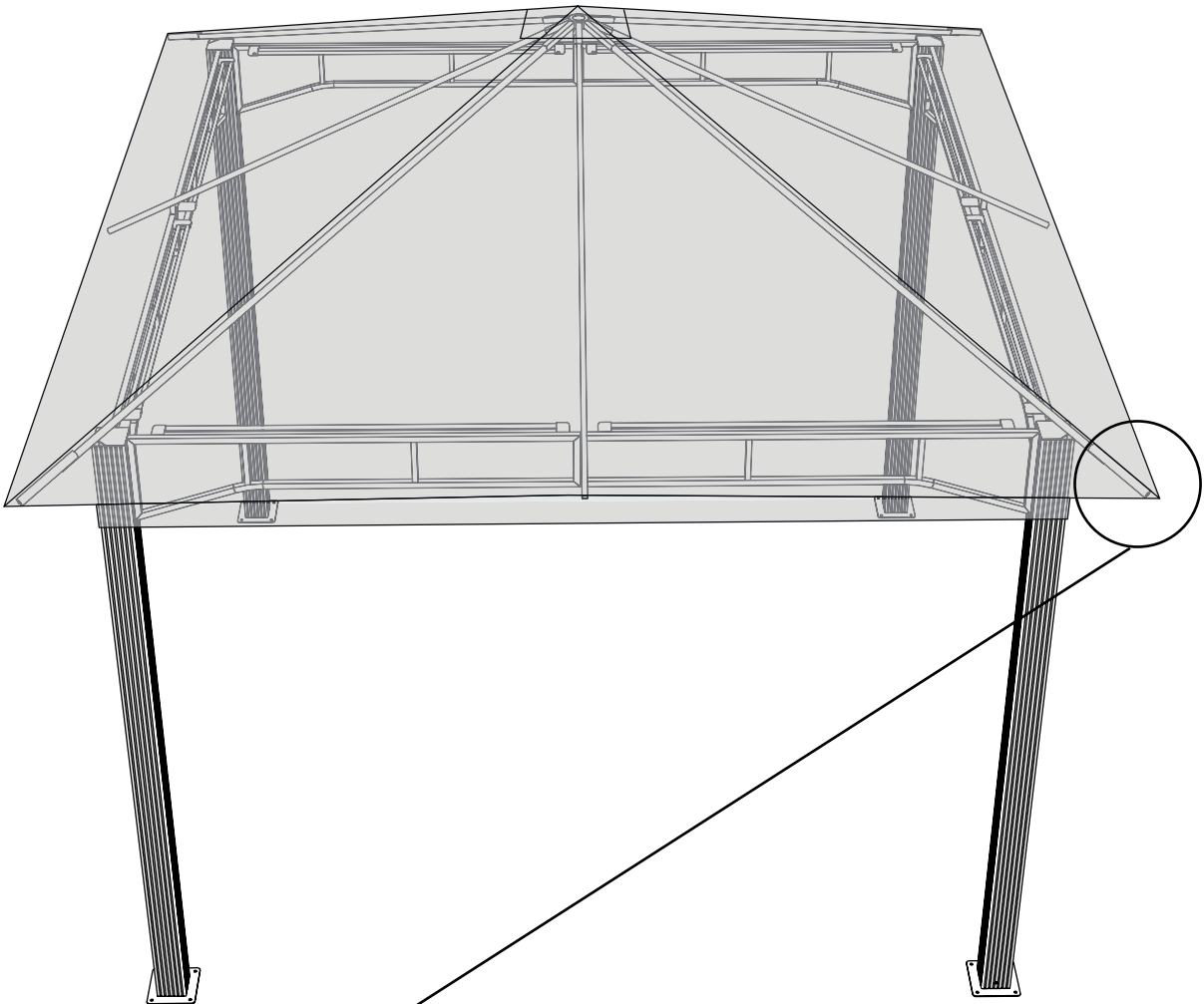

 **GG-L1-Q2 3 m x 3 m**

15

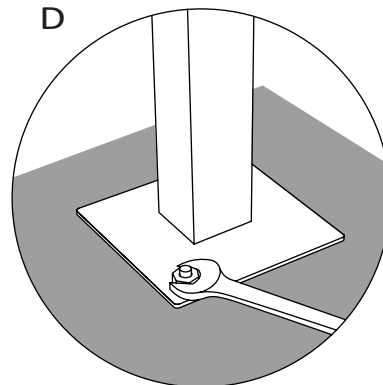
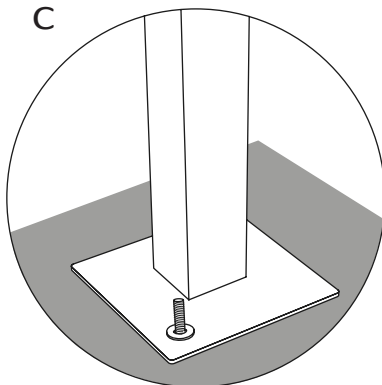
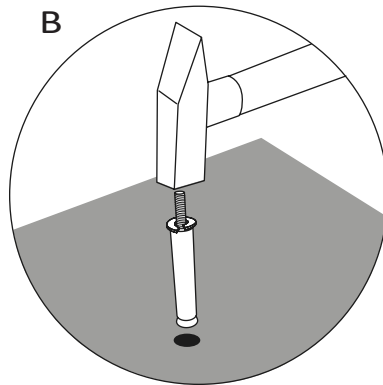
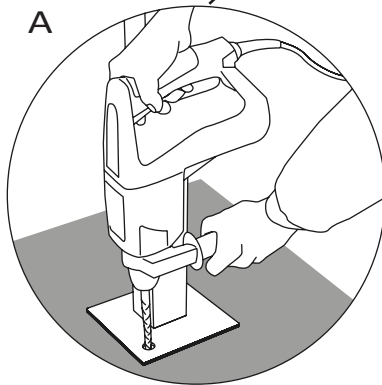
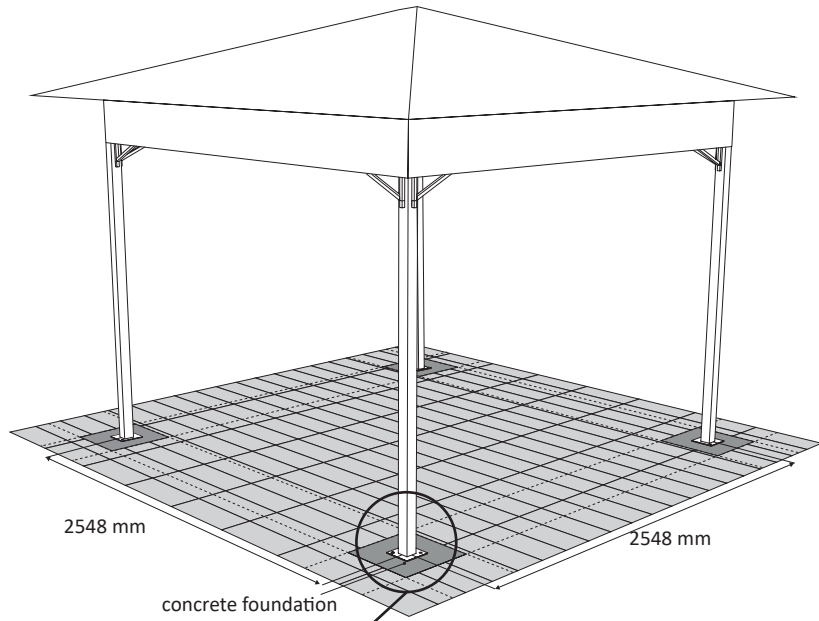
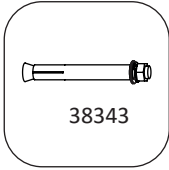

 **GG-L1-Q2 3 m x 3 m**

16

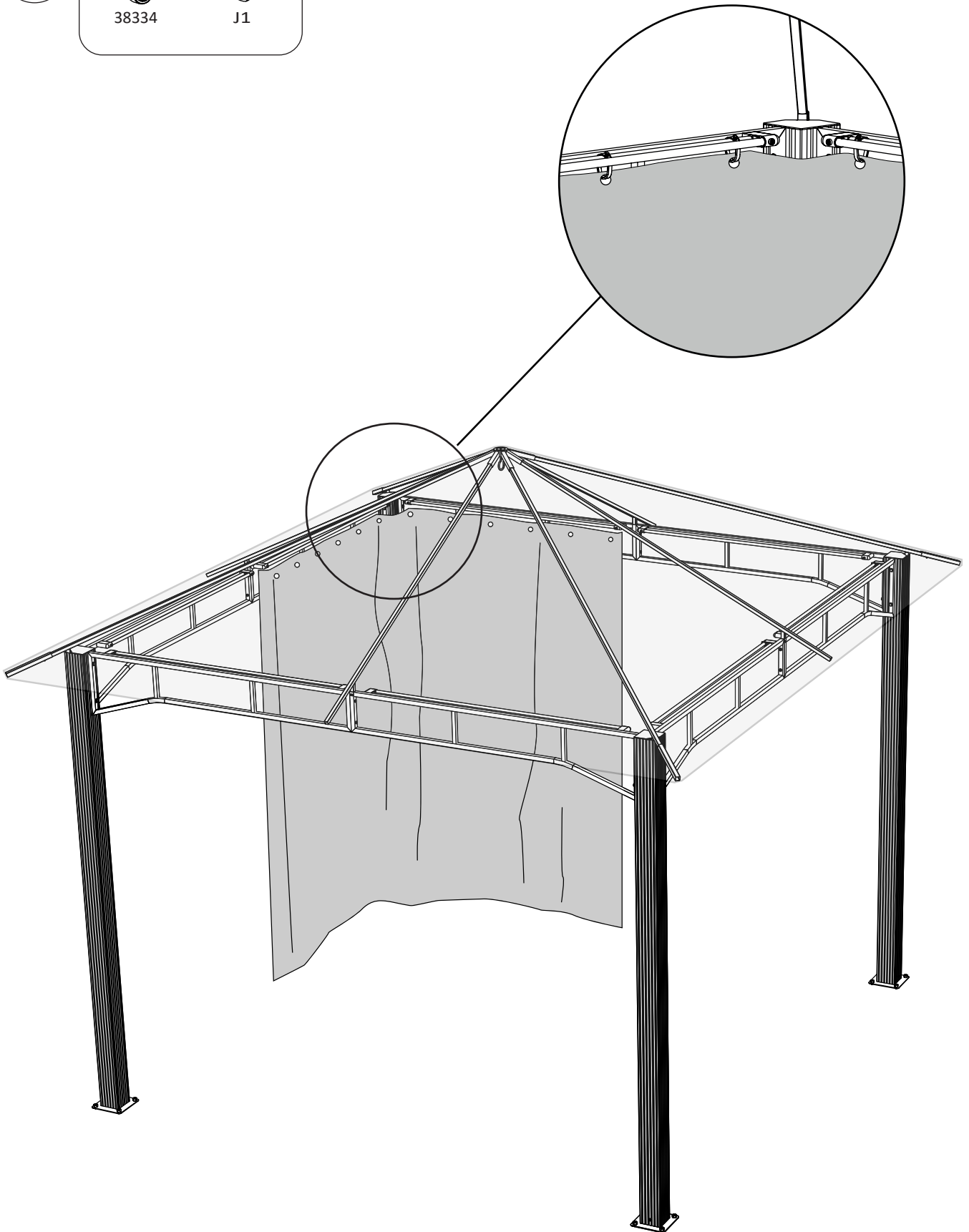
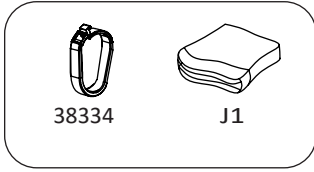

 **GG-L1-Q2 3 m x 3 m**

17

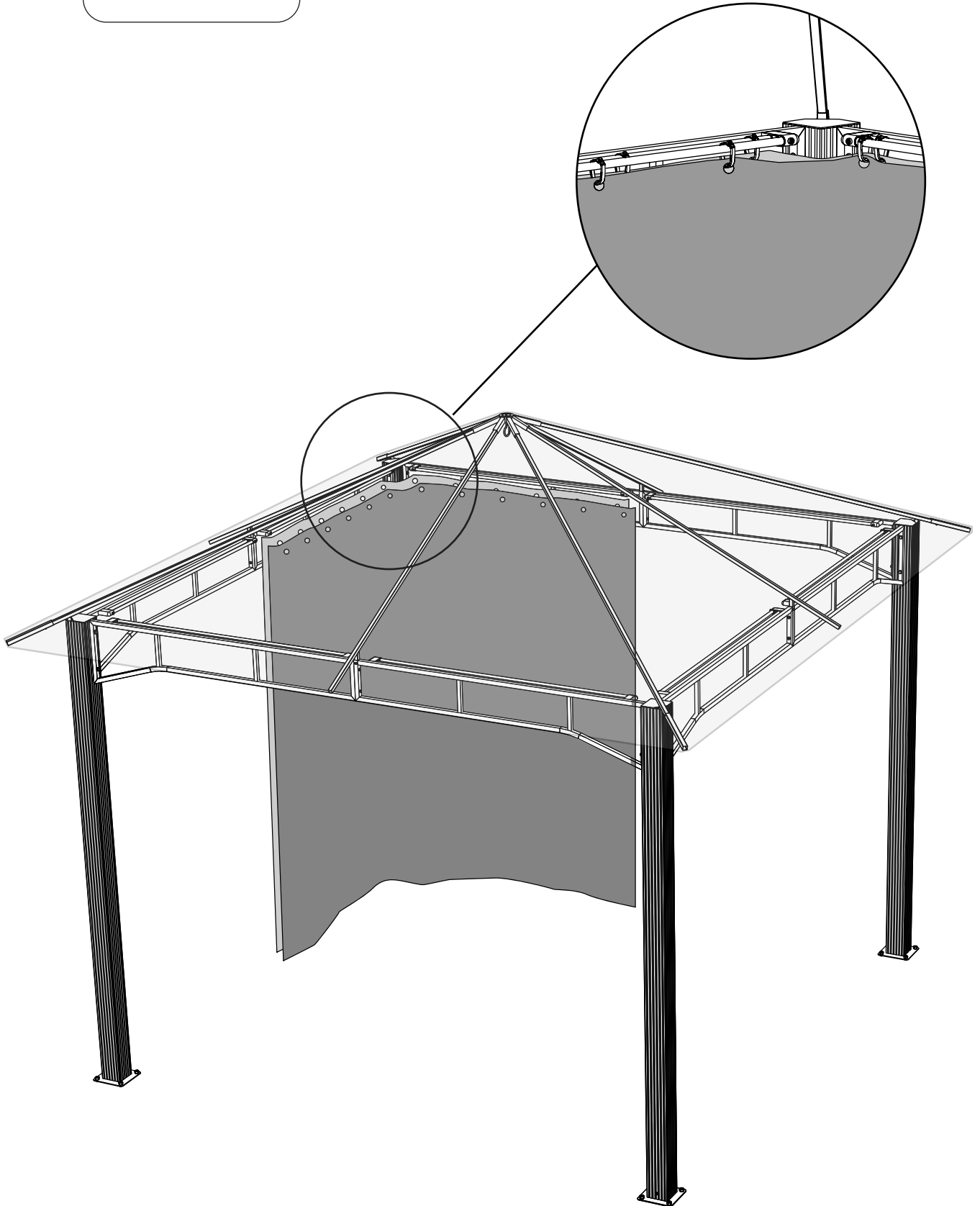

 **GG-L1-Q2 3 m x 3 m**

18

