

 **GG-L1-Q2 4 m x 4 m**



01/2026-01

TOOLPORT

 **GG-L1-Q2 4 m x 4 m**

A

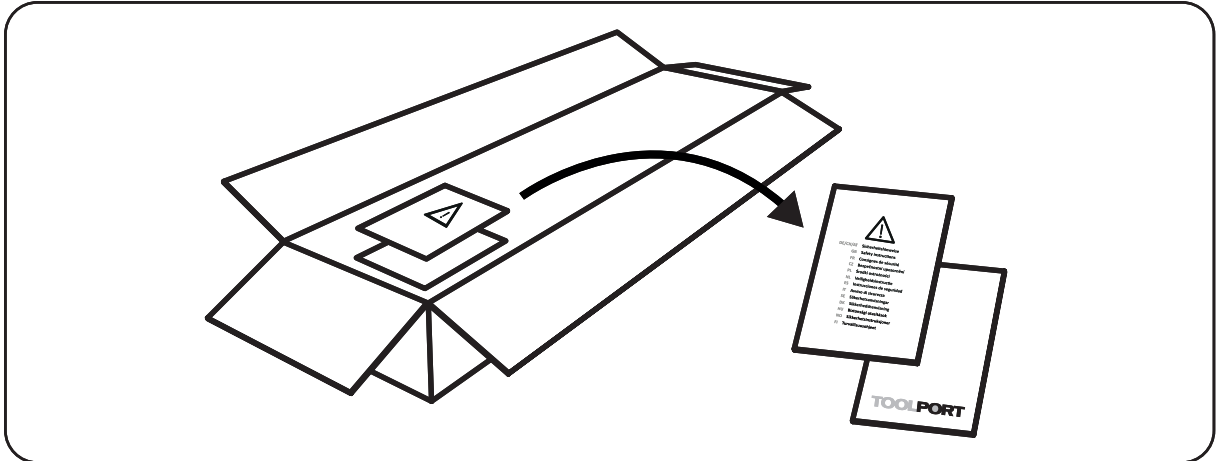



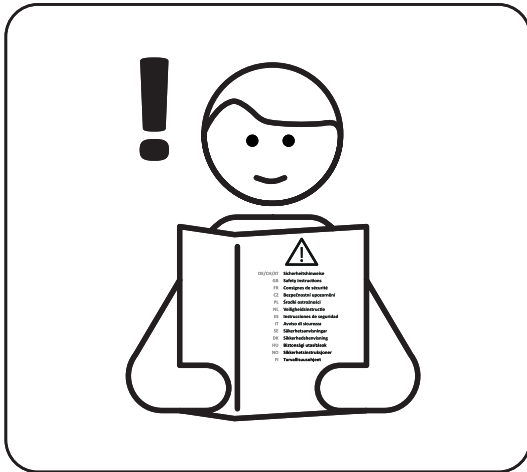



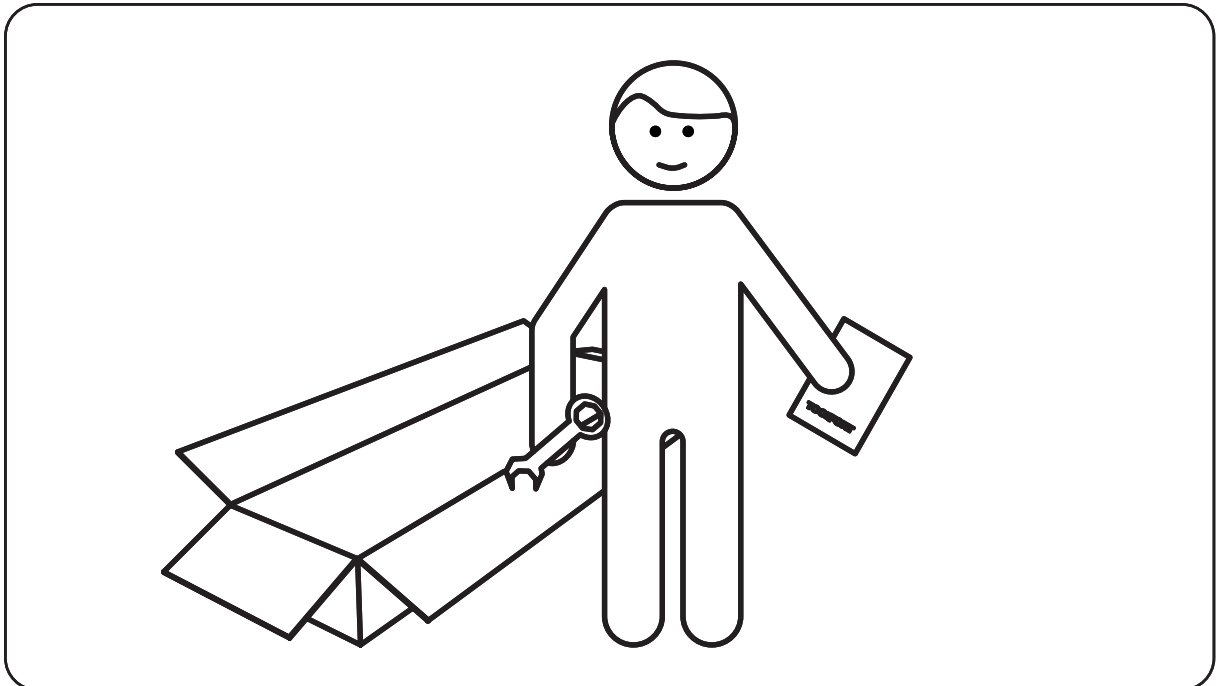







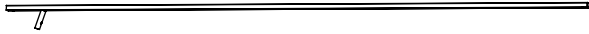

B





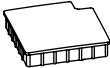





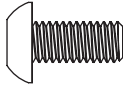

C

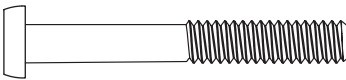
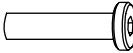

 **GG-L1-Q2 4 m x 4 m**

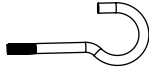
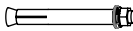
Item no.	ID		Q'ty
50562	A1		4
50655	B5		4
50656	B6		4
38328	C2		16
38329	D1		4
38386	D2		4
38387	D3		12
38331	D4		4
50648	E1		1
38388	E2		8
50576	F1		4
38332	G1		16
38333	G2		4
38334	H1		96+4
	J1		1
	J2		1

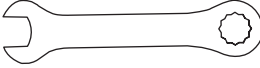
 **GG-L1-Q2 4 m x 4 m**

Item no.	ID			Q'ty
	K1			1
38335	1	M6 x 15 mm		12+1
38336	2	M6 x 30 mm		16+1
38337	3	M6 x 65 mm		16+1
38338	4			8+1
38339	5			8+1
38340	6			16+1
38341	7			16+1
38342	8			1
38343	9			8
38344	10			2
38345	11			1
38389	12			8

 **GG-L1-Q2 4 m x 4 m**

1

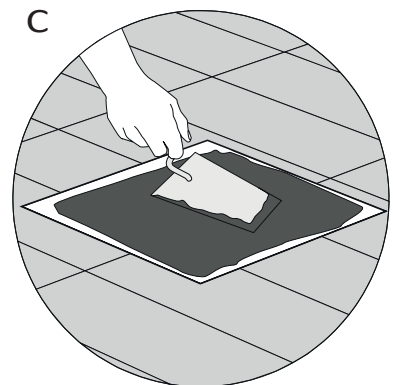
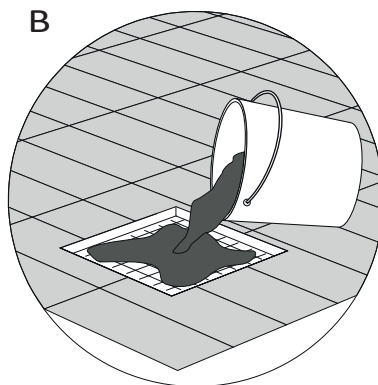
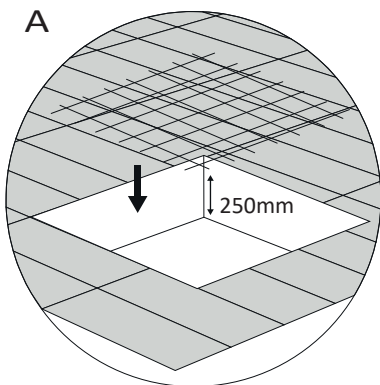
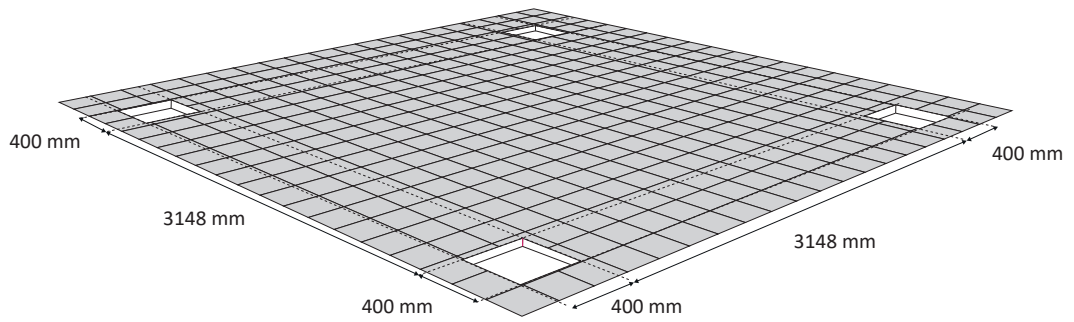
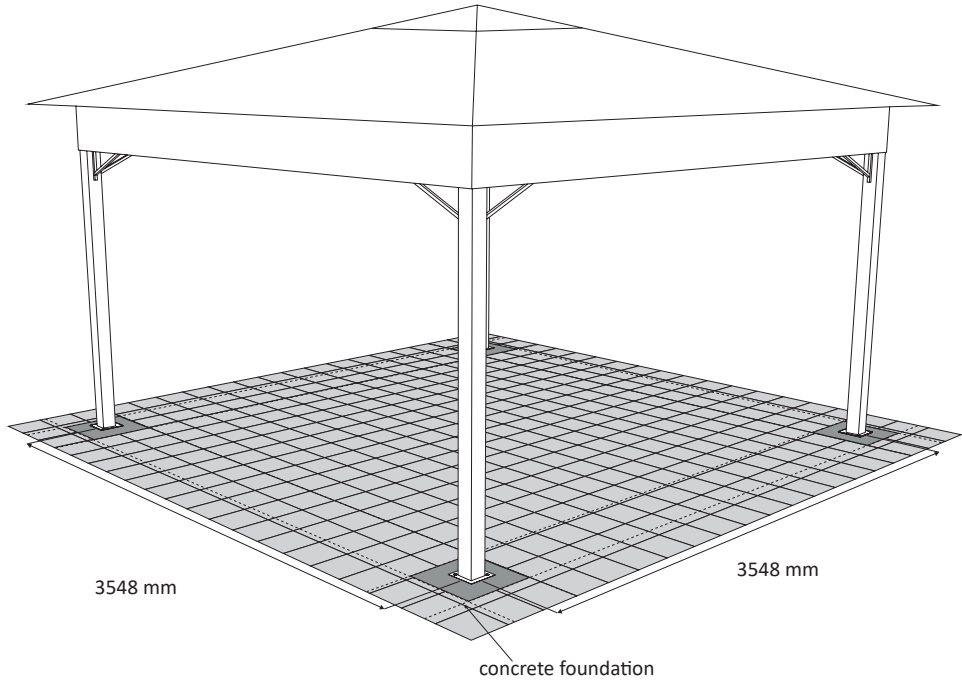

 **GG-L1-Q2 4 m x 4 m**

2

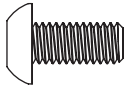

38335 (1)



50562 (A1)



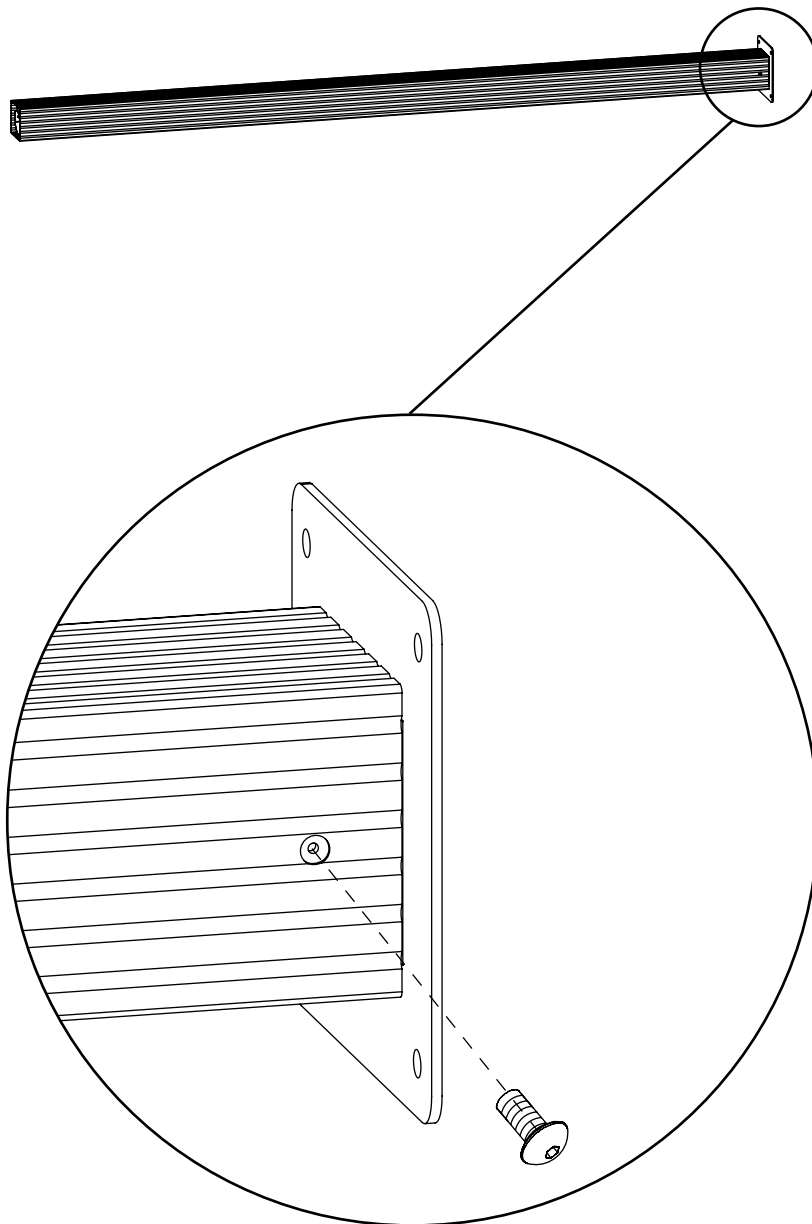

50576 (F1)

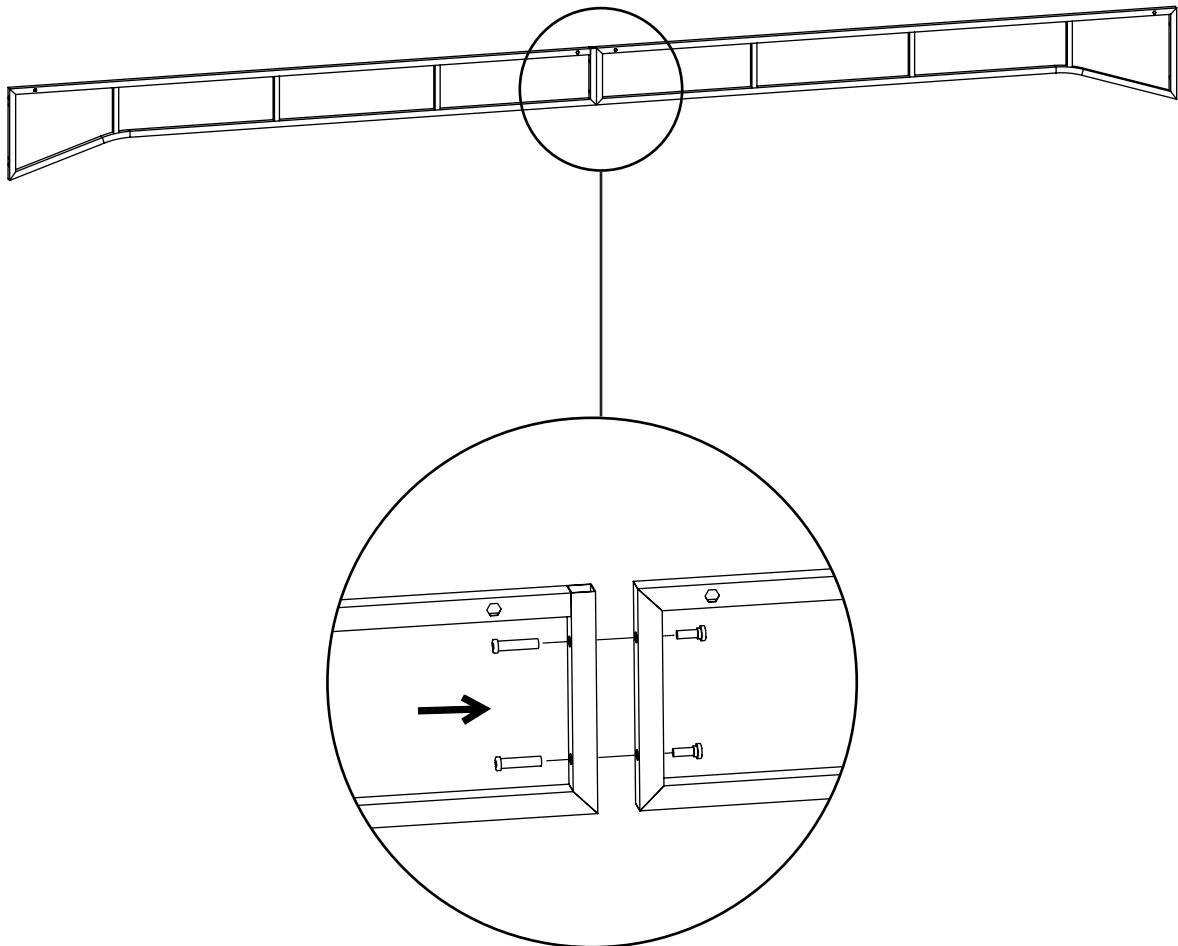
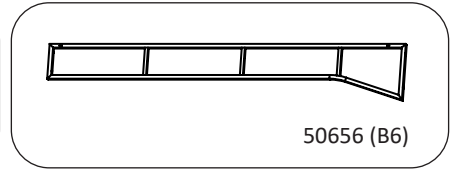
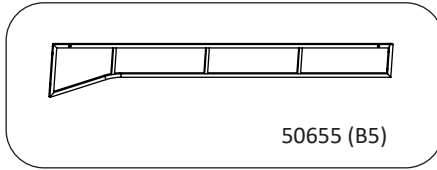
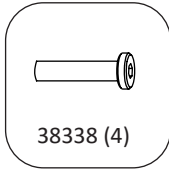
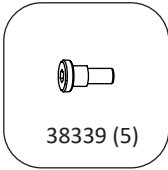

 **GG-L1-Q2 4 m x 4 m**

3



 **GG-L1-Q2 4 m x 4 m**

4

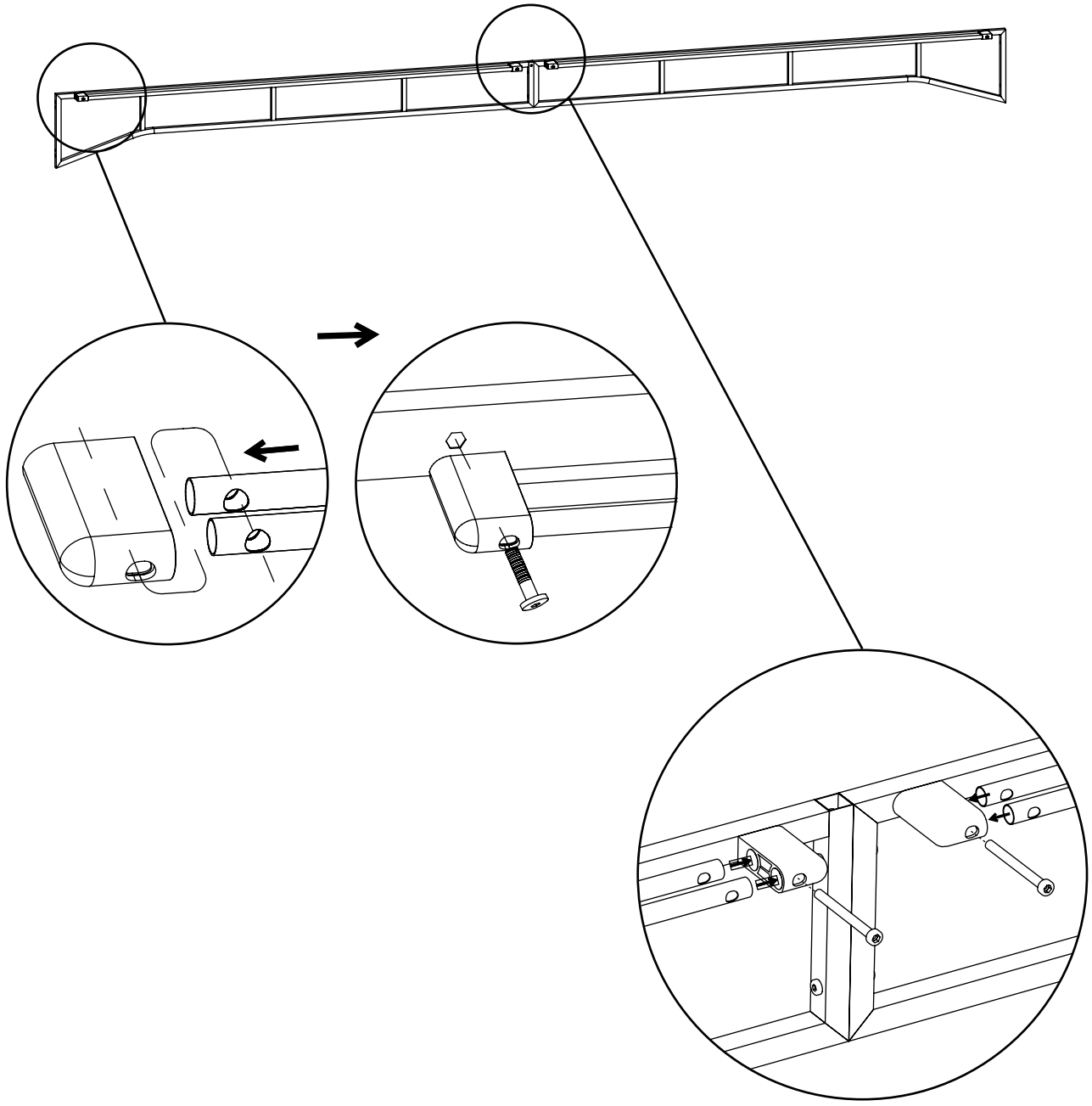
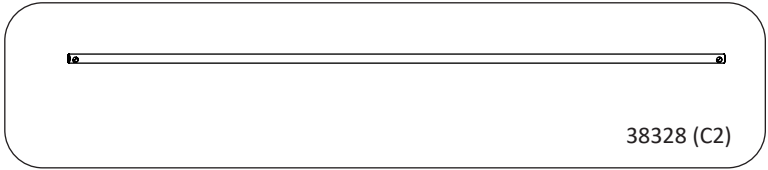
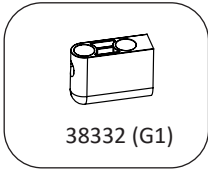
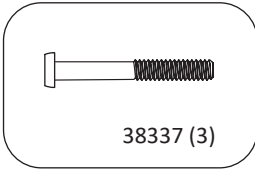

 **GG-L1-Q2 4 m x 4 m**

5

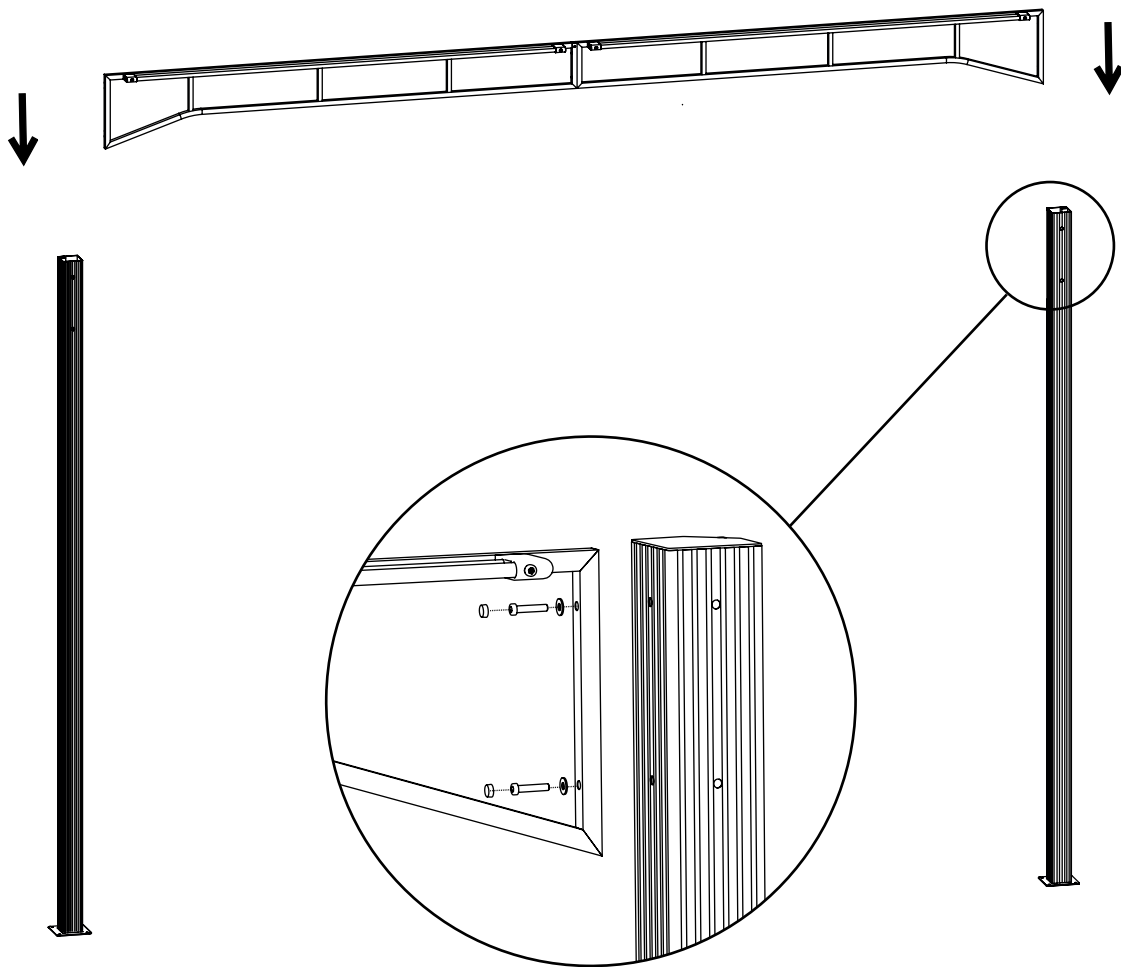
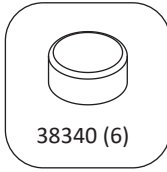
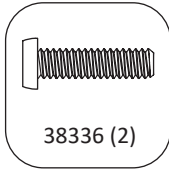

 **GG-L1-Q2 4 m x 4 m**

6

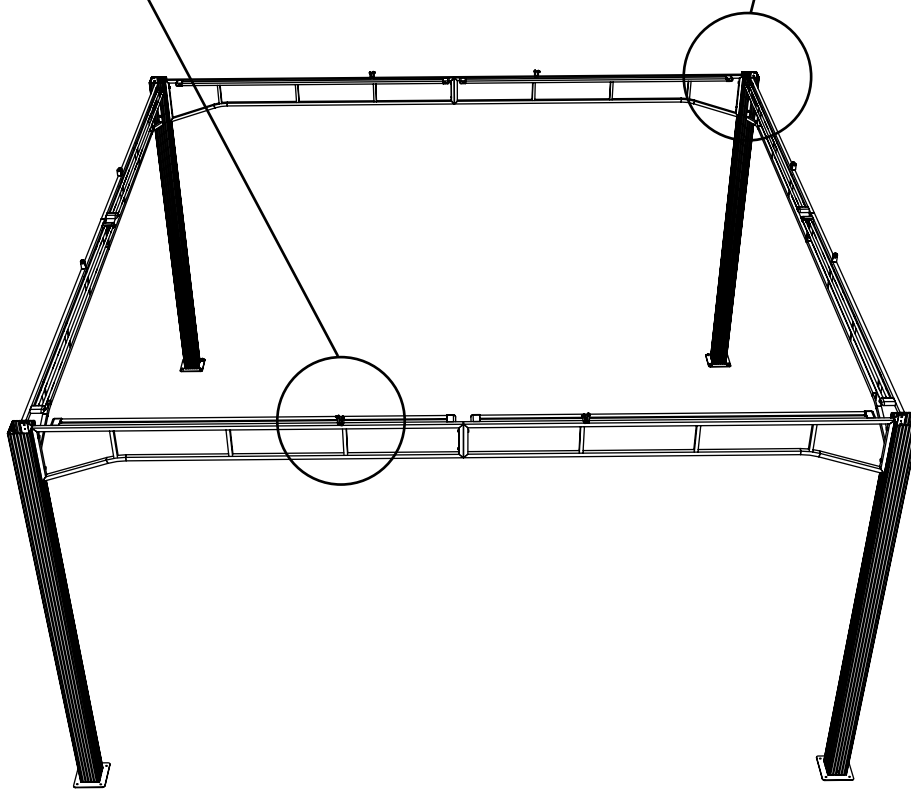
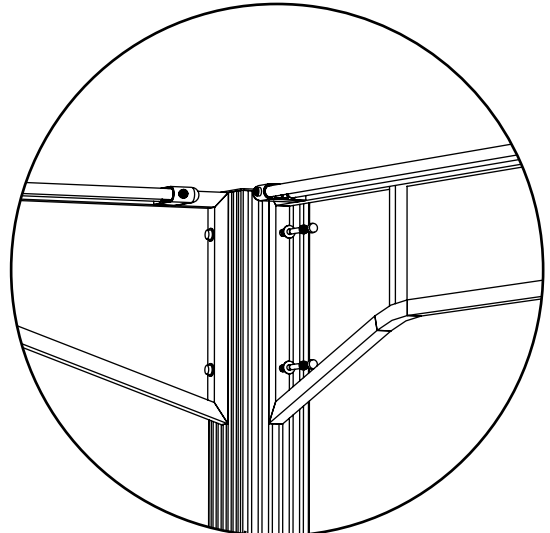
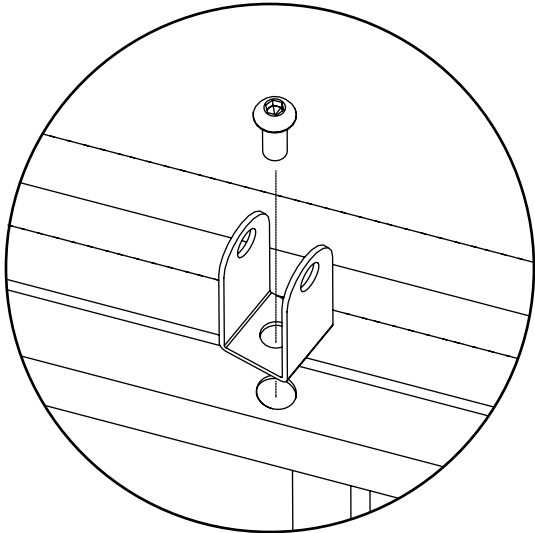
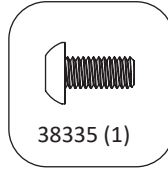
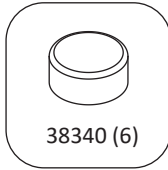
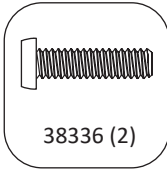

 **GG-L1-Q2 4 m x 4 m**

7

A

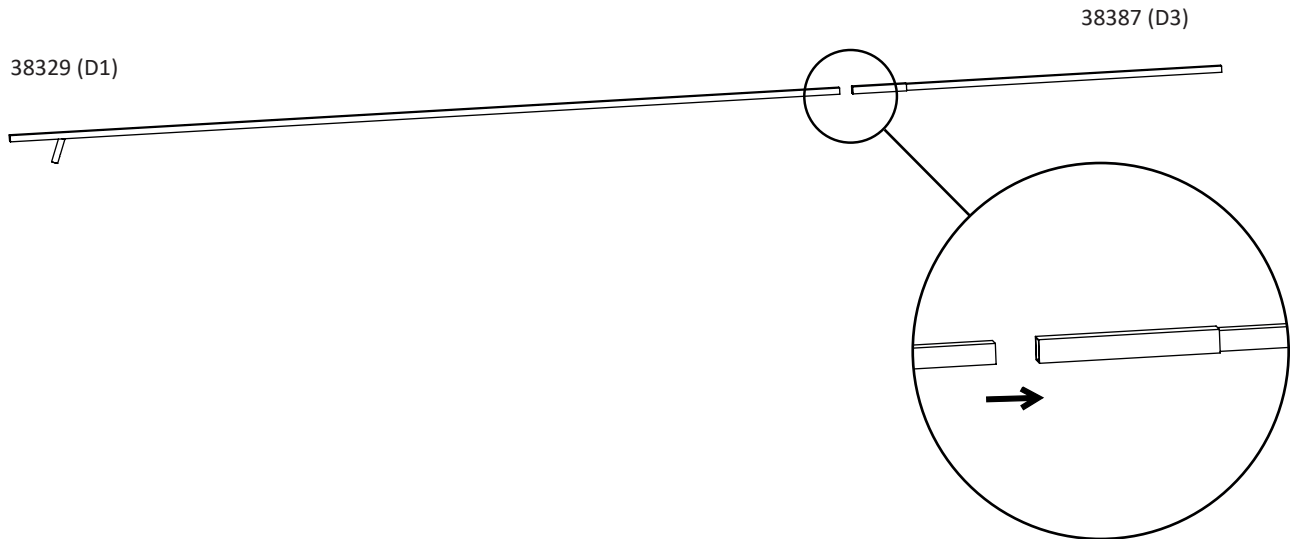
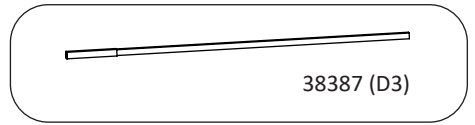
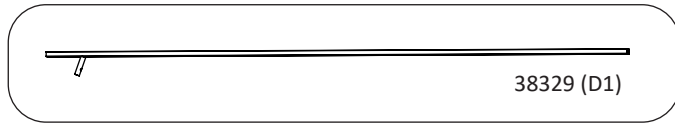

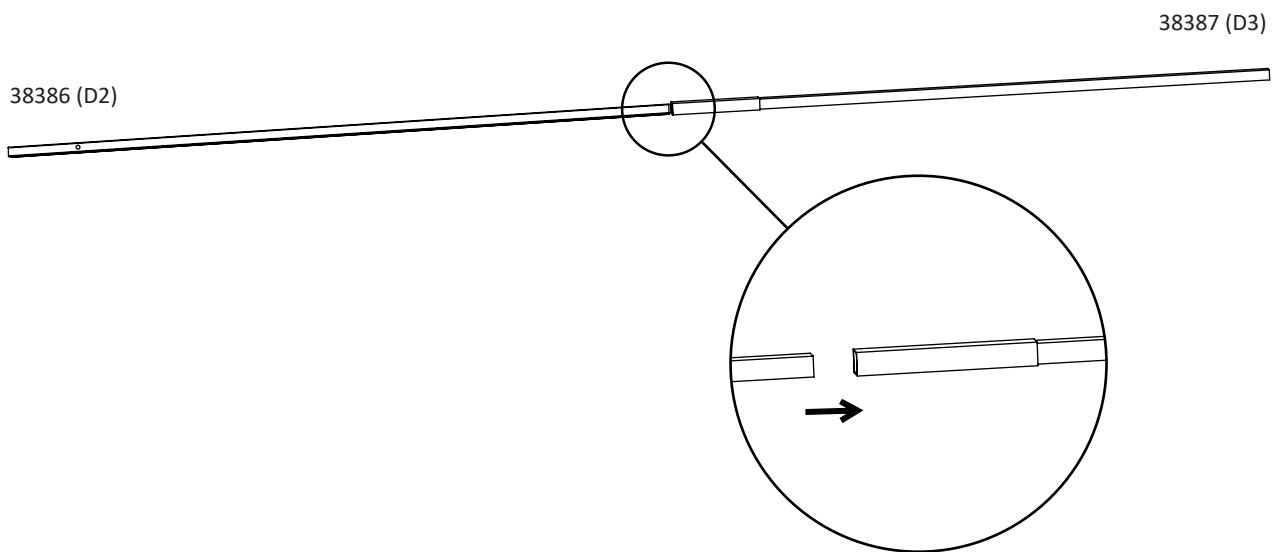
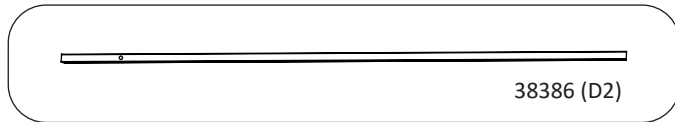

B

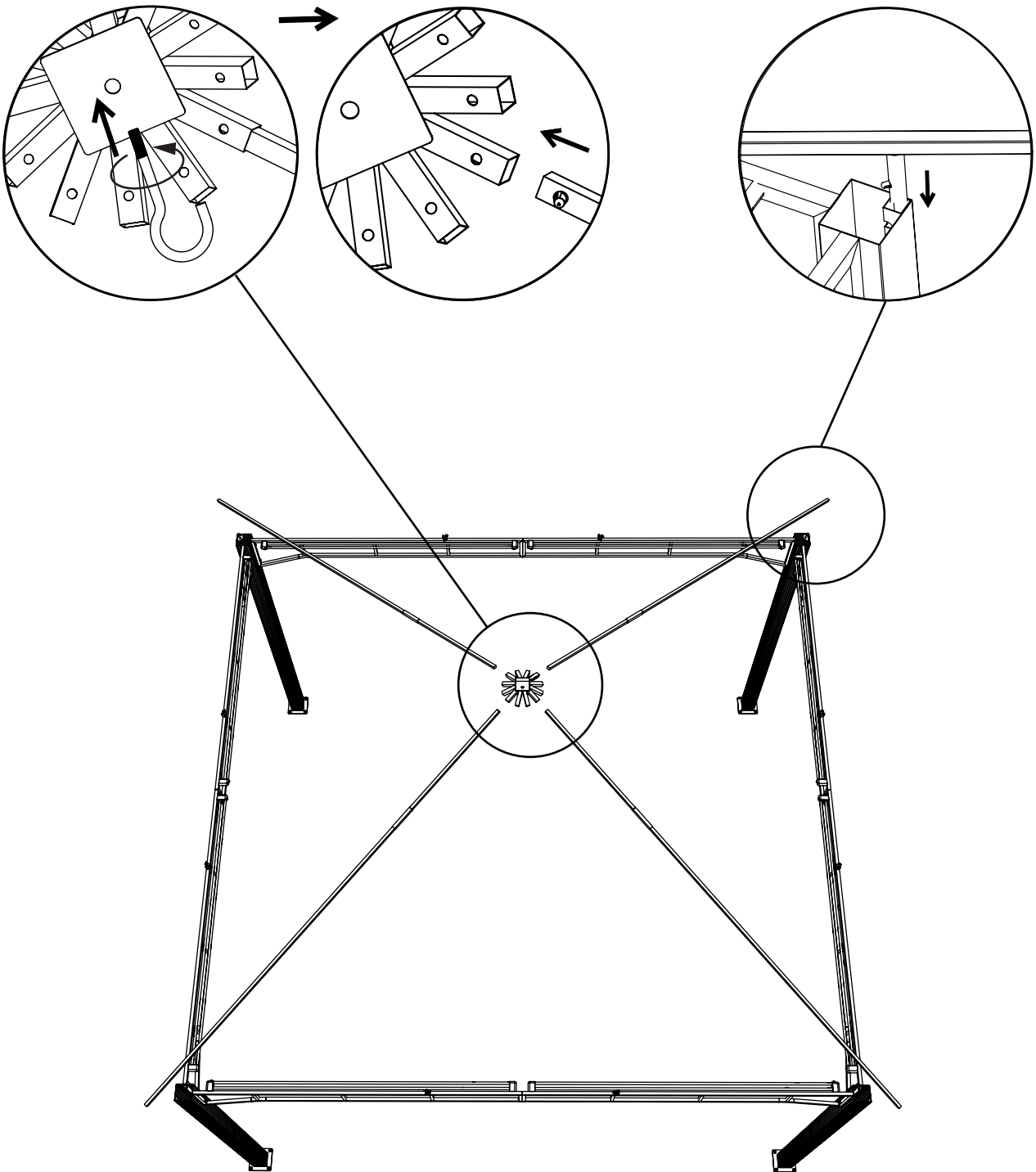
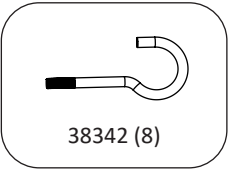
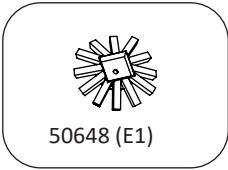

 **GG-L1-Q2 4 m x 4 m**

8



 **GG-L1-Q2 4 m x 4 m**

8

B 
38386 (D2) + 38387 (D3)



38336 (2)

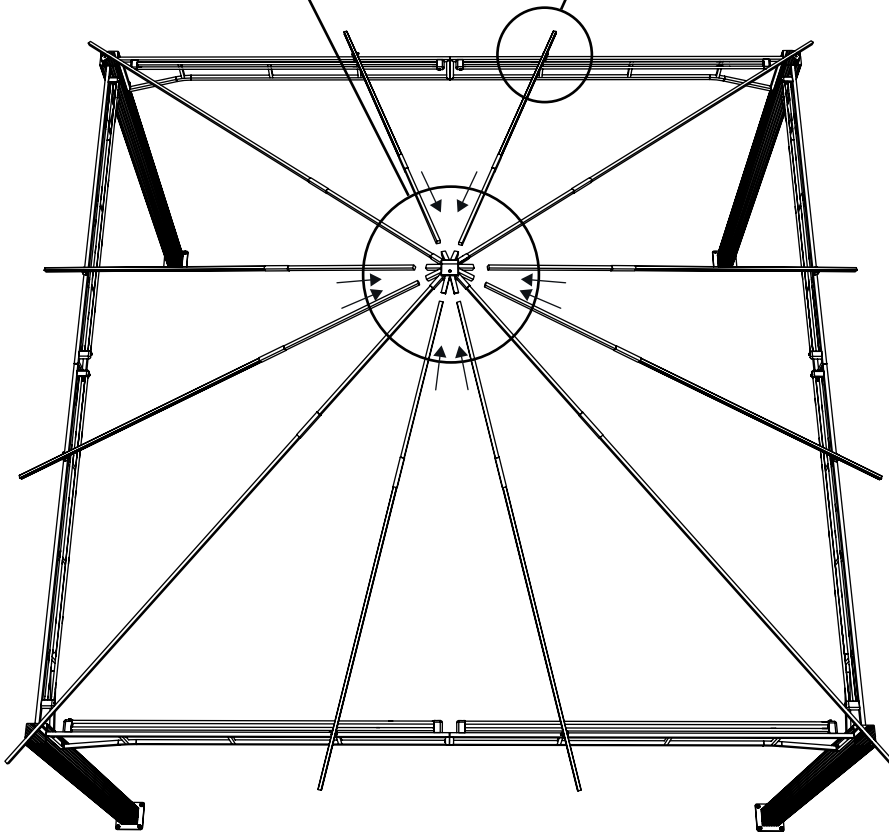
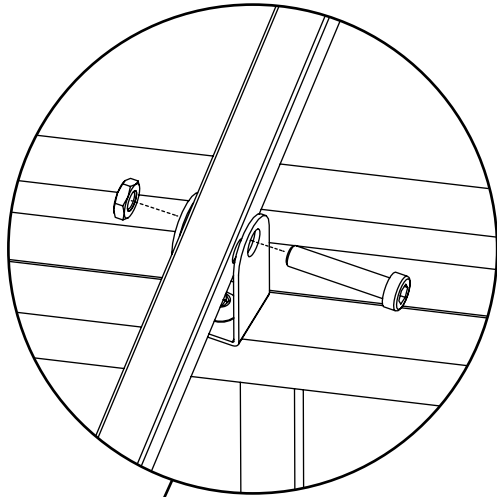
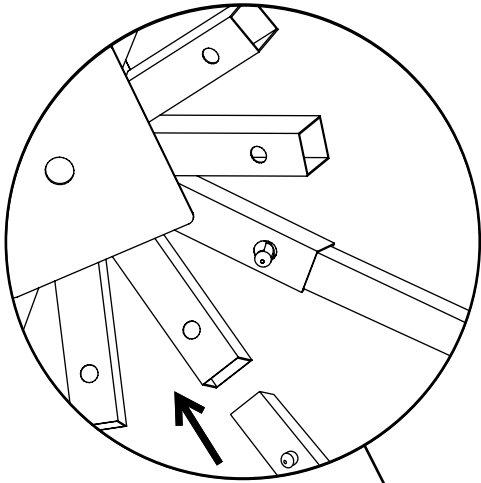

38389 (12)

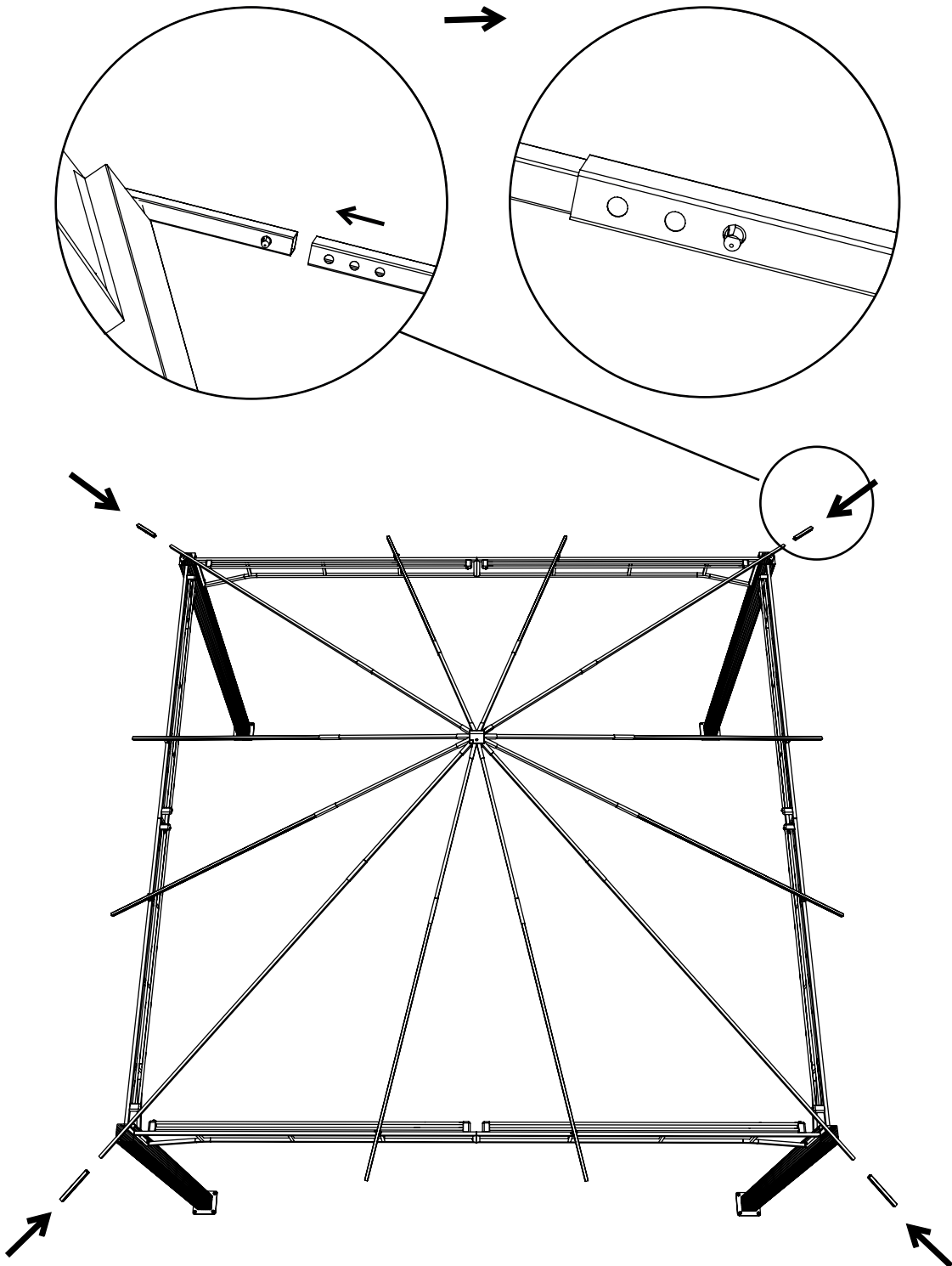
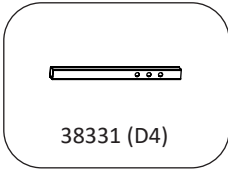

 **GG-L1-Q2 4 m x 4 m**

9



 **GG-L1-Q2 4 m x 4 m**

10

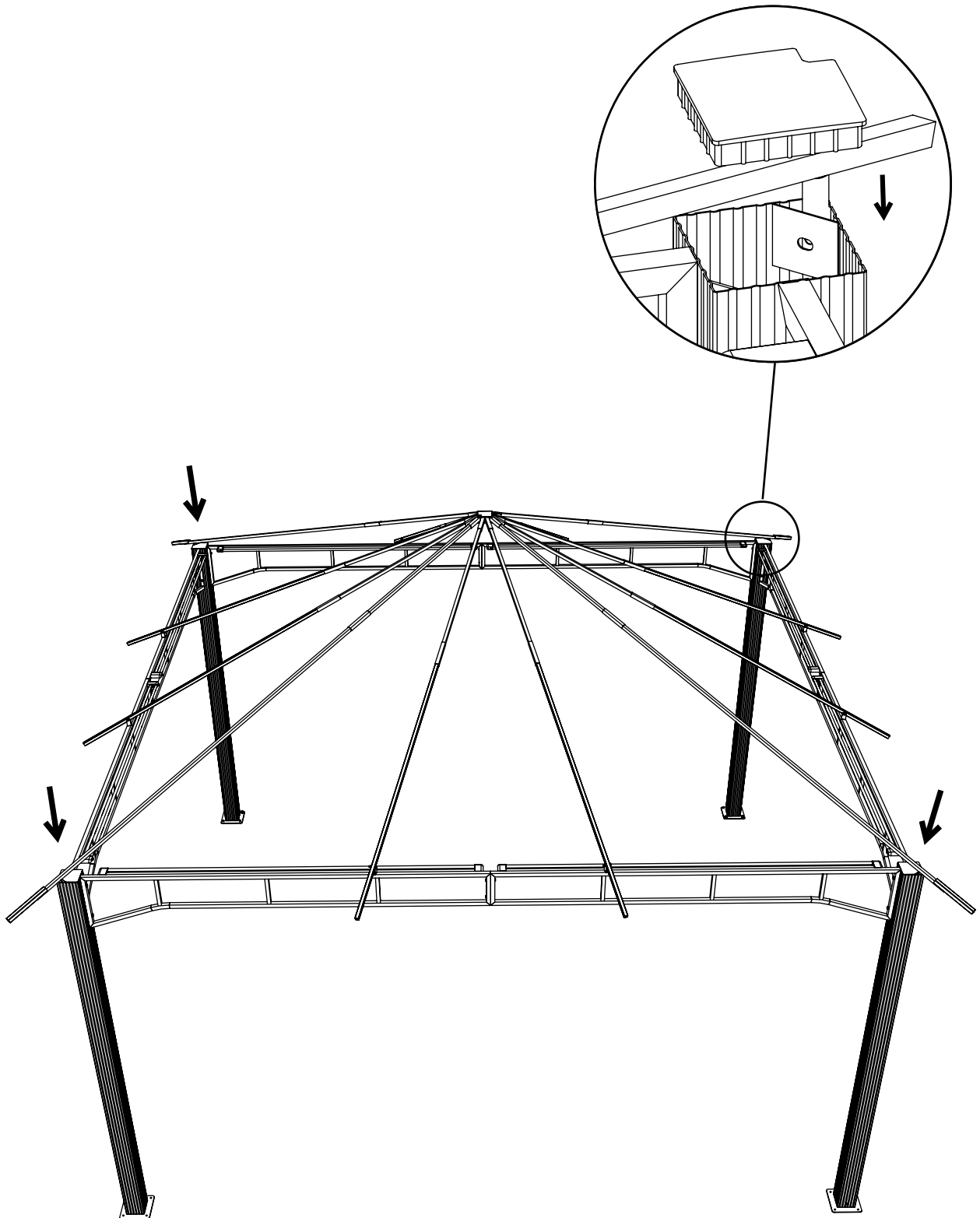

 **GG-L1-Q2 4 m x 4 m**

11

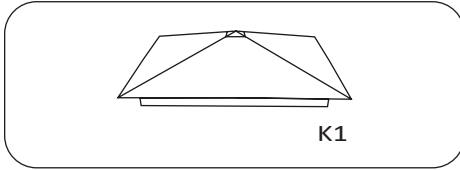

 **GG-L1-Q2 4 m x 4 m**

12

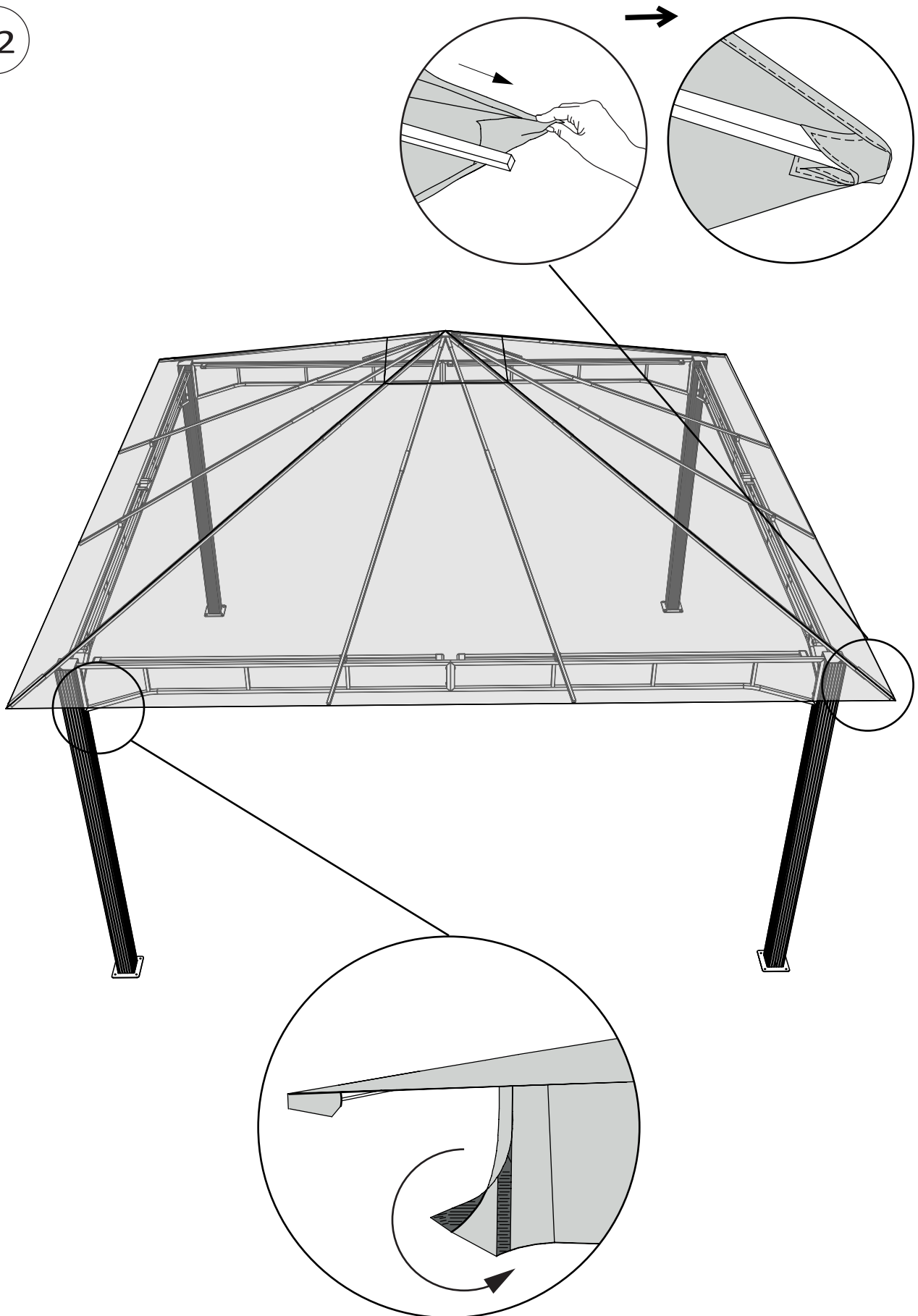

 **GG-L1-Q2 4 m x 4 m**

13

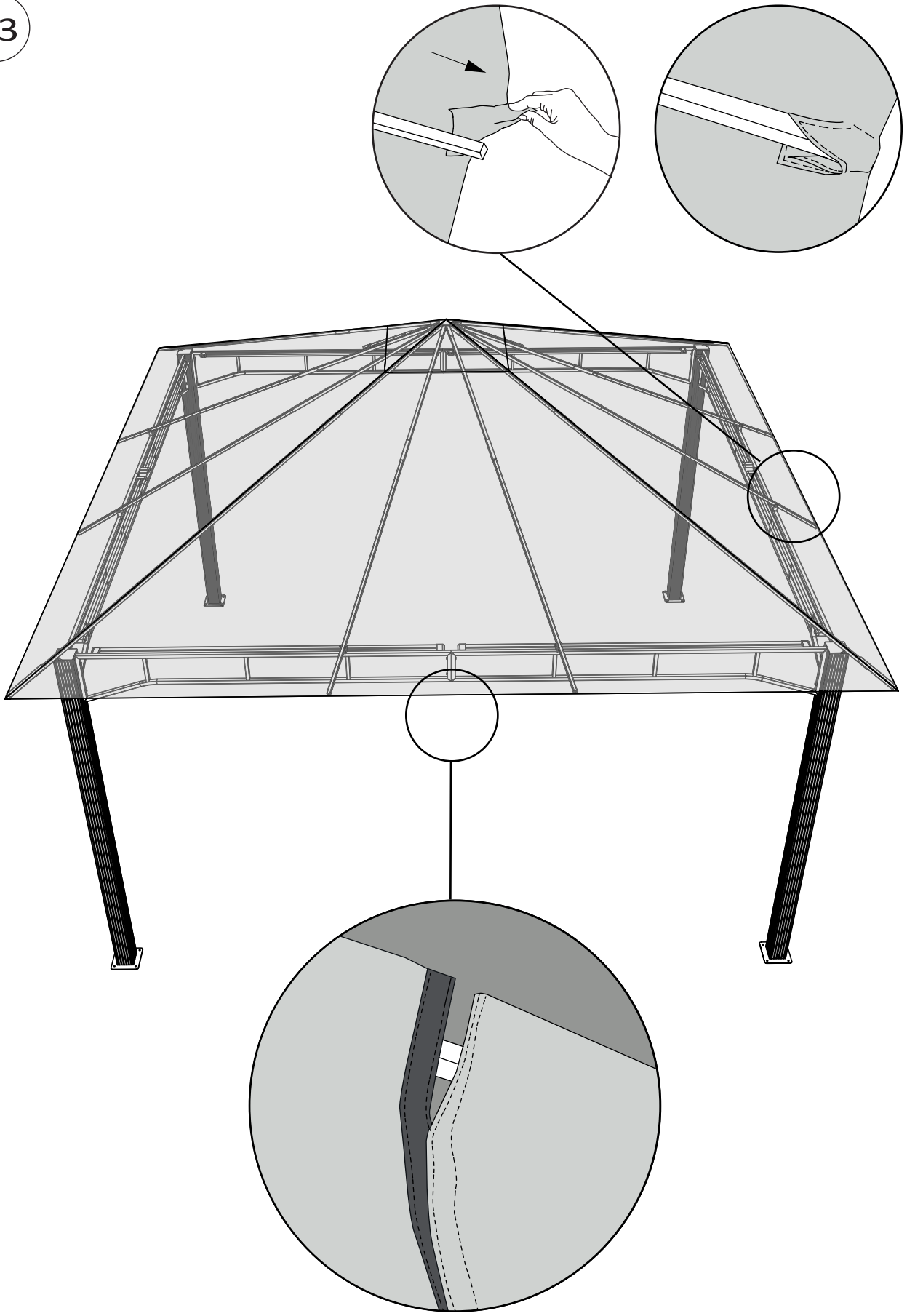

 **GG-L1-Q2 4 m x 4 m**

14

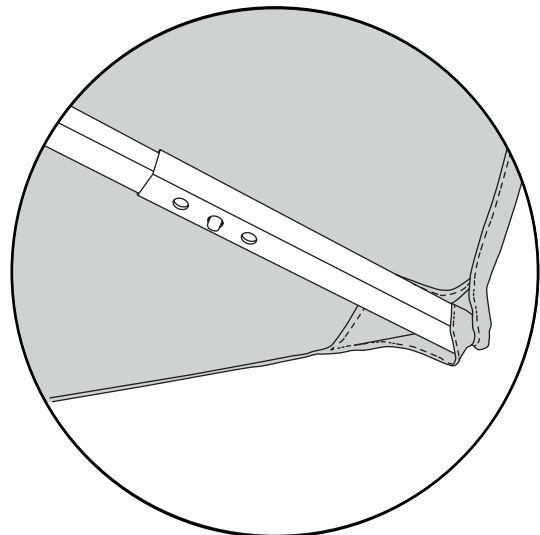
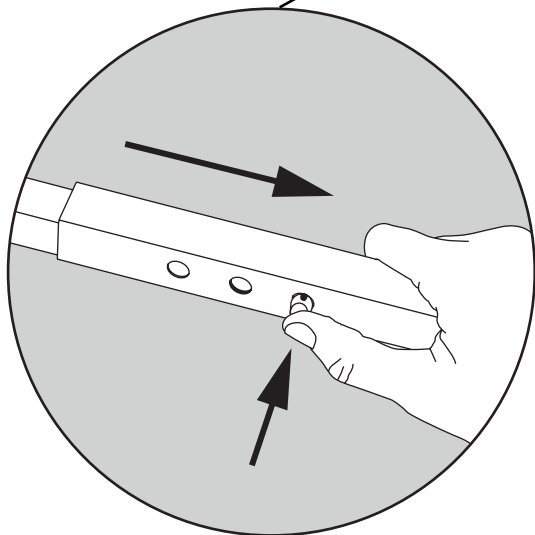
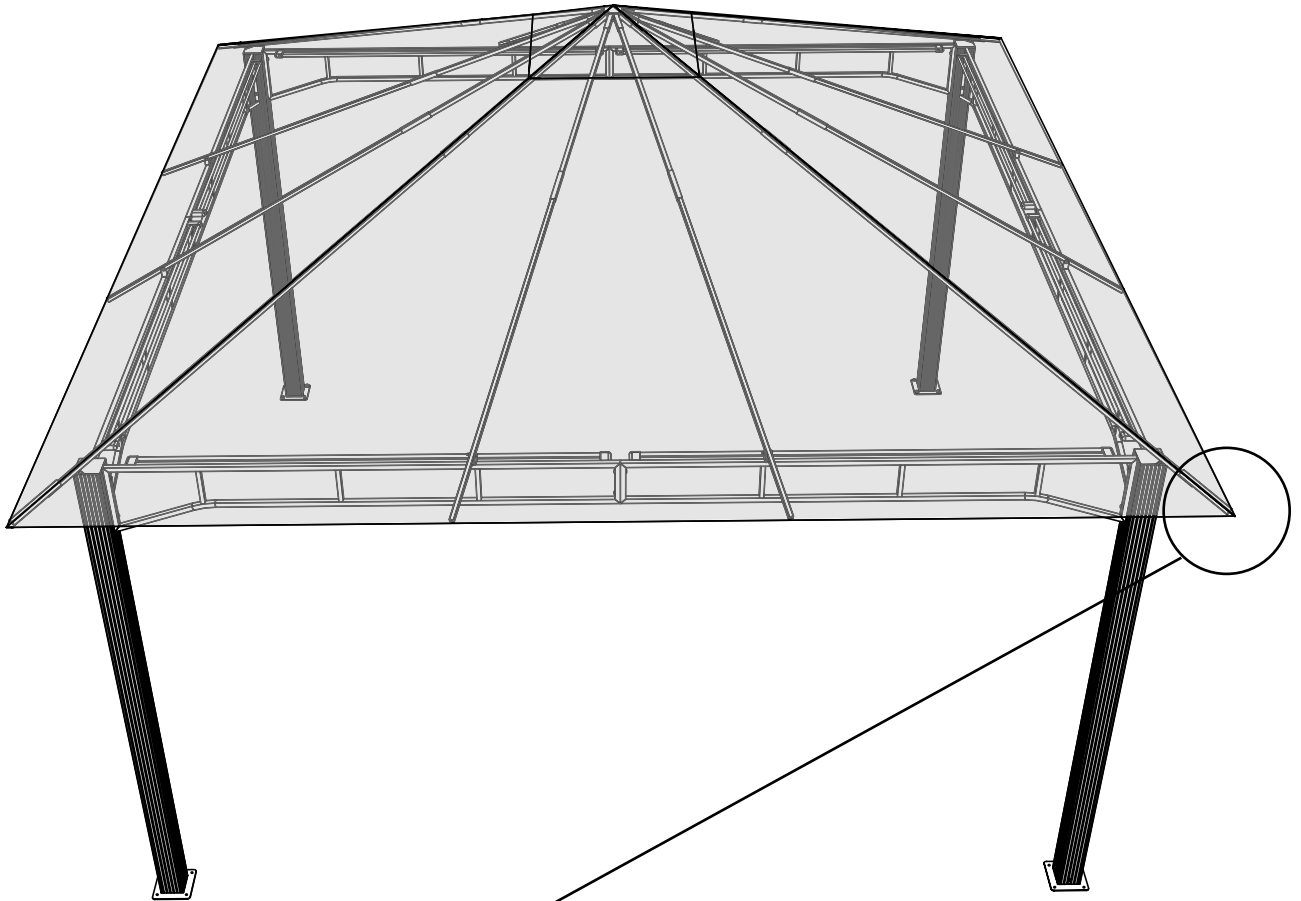

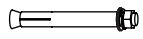

 **GG-L1-Q2 4 m x 4 m**

15



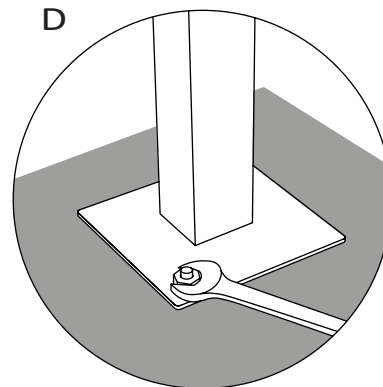
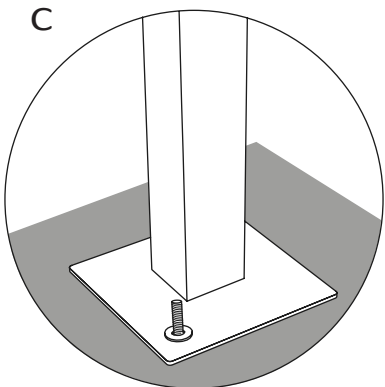
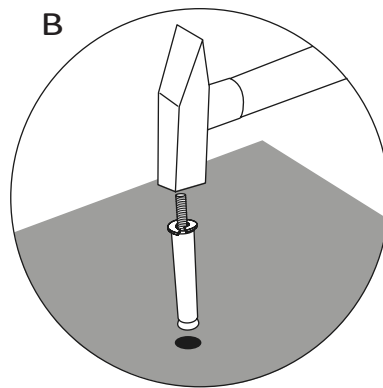
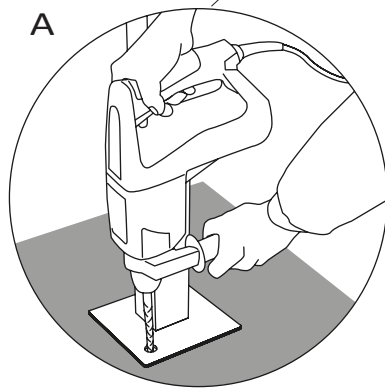
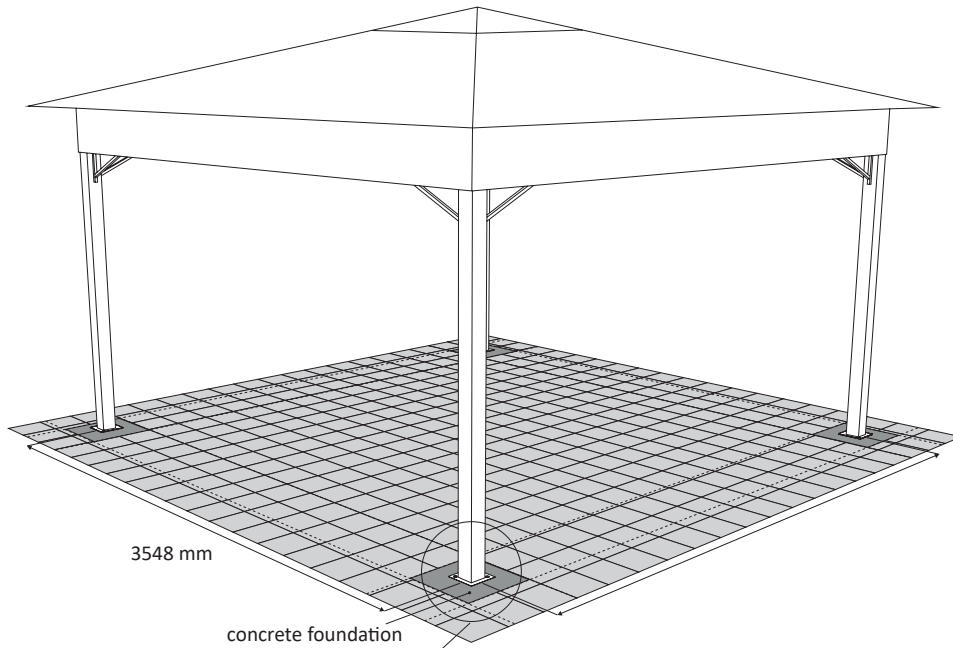

38343 (9)

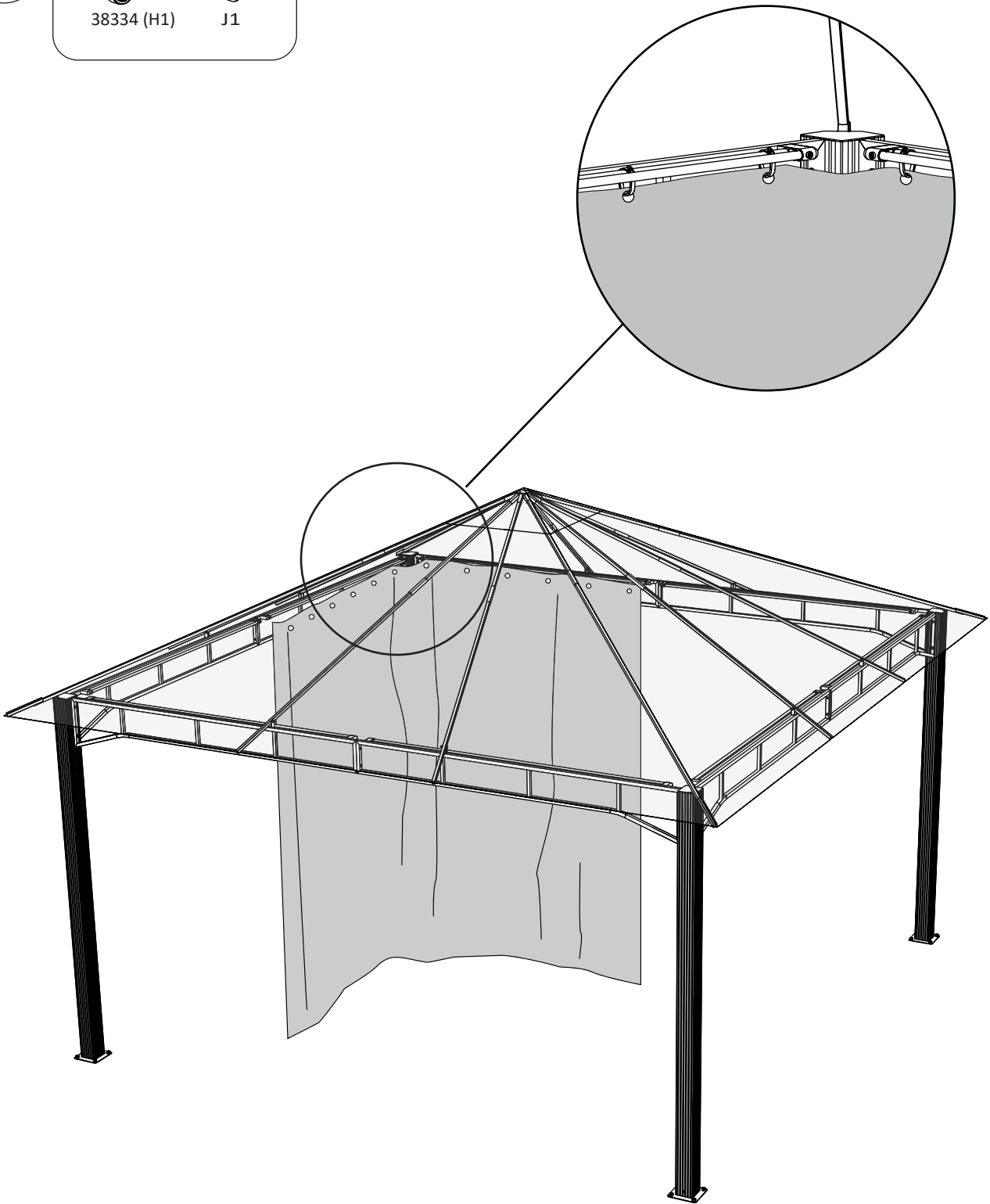
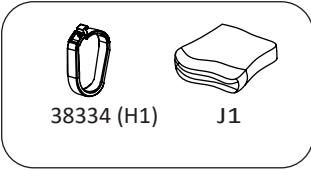

 **GG-L1-Q2 4 m x 4 m**

16



 **GG-L1-Q2 4 m x 4 m**

17

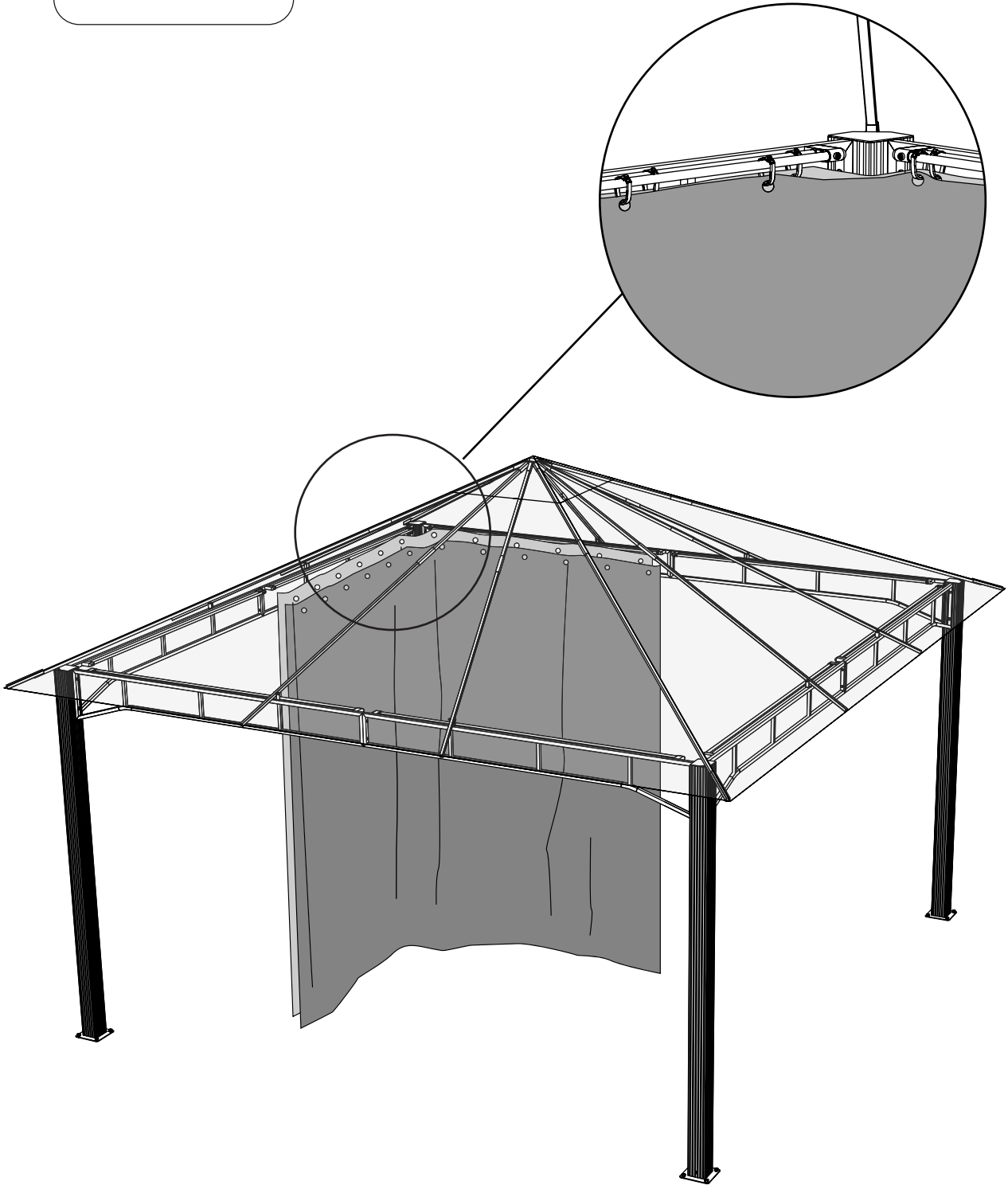
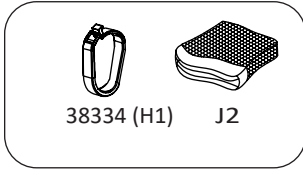

 **GG-L1-Q2 4 m x 4 m**

18

