

 **PAG-L2-Q4 3 m x 3 m**

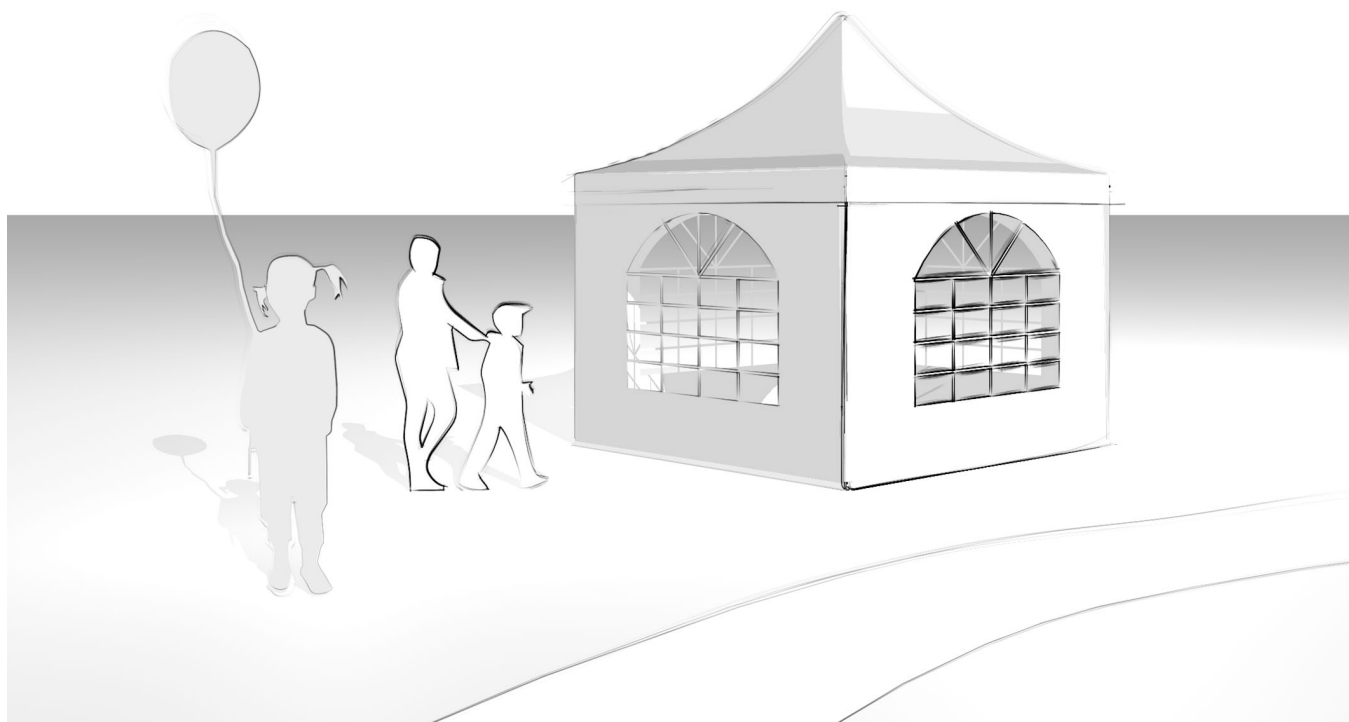

01/2025-02

TOOLPORT

 **PAG-L2-Q4 3 m x 3 m**

A

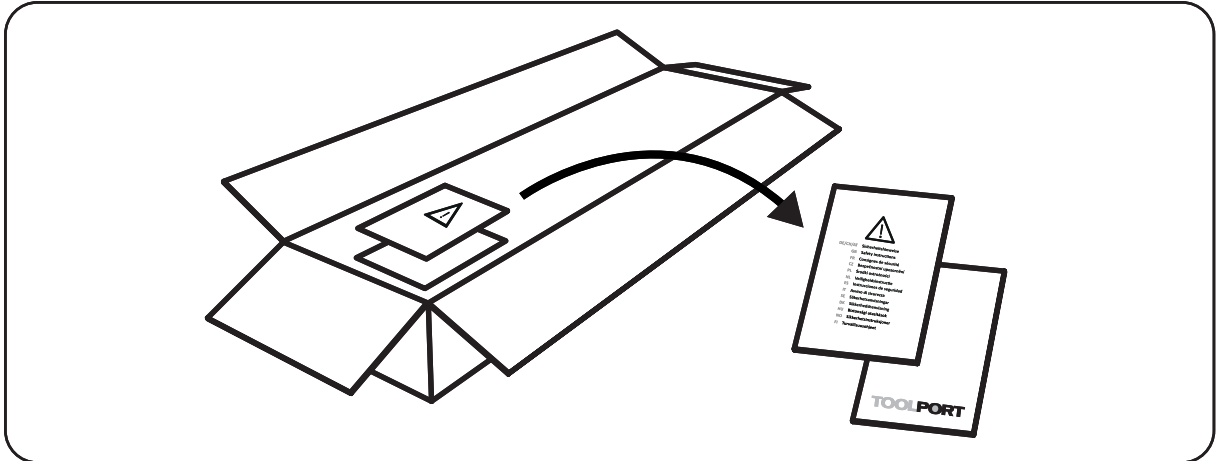



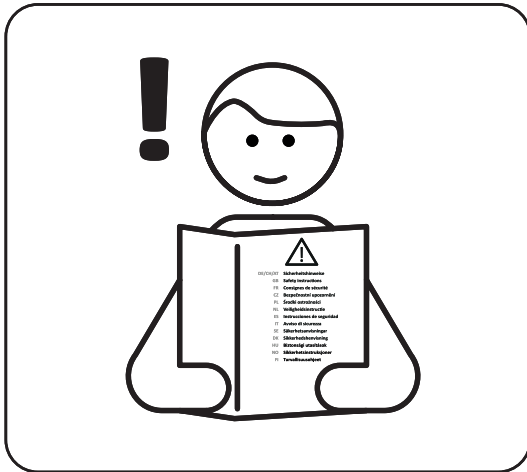



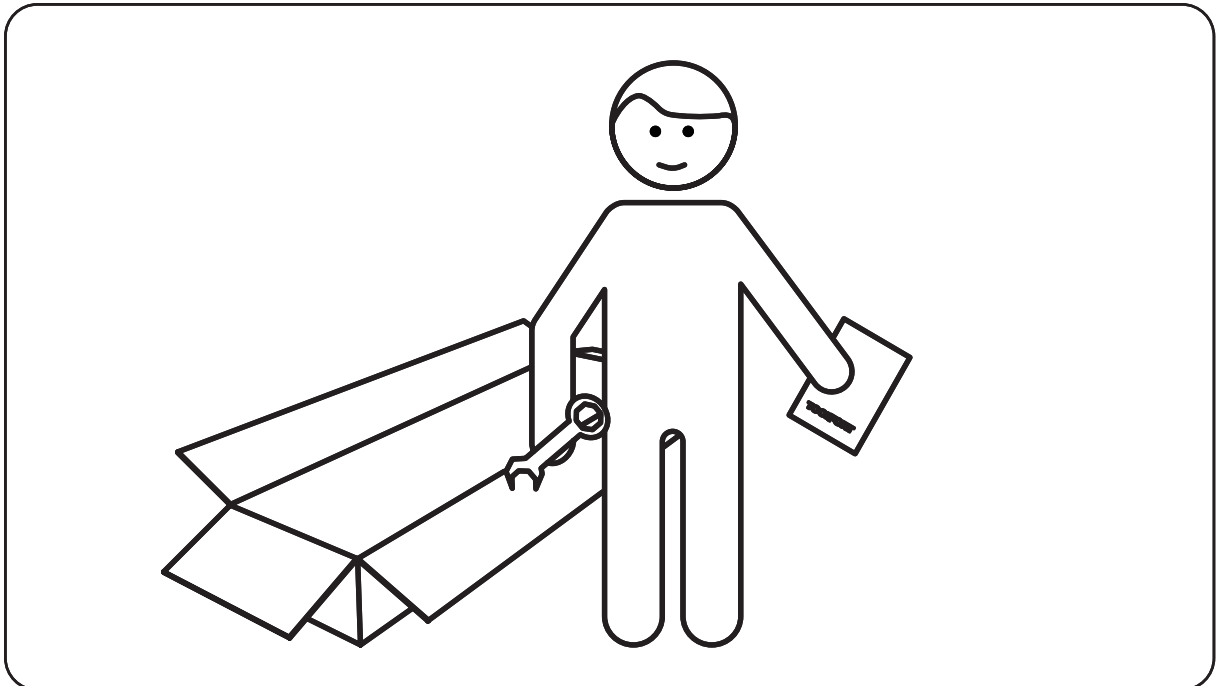

B

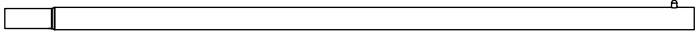
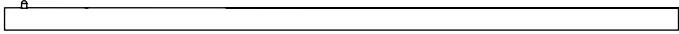
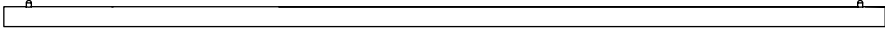
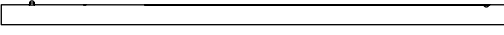
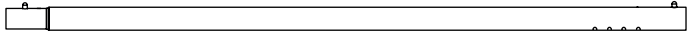
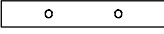
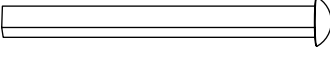
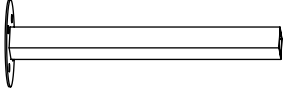





C

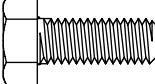

 **PAG-L2-Q4 3 m x 3 m**

Item no.		Q'ty
20754	 <p>Ø 32 x 1043 mm</p>	4
20755	 <p>Ø 32 x 1040 mm</p>	4
20756	 <p>Ø 38 x 1410 mm</p>	8
20757	 <p>Ø 38 x 905 mm</p>	4
20758	 <p>Ø 38 x 1182 mm</p>	4
20759	 <p>Ø 41 x 250 mm</p>	4
20760		1
20761		1
20764		4
20763		1
33079		4
20762		1
-		1
-		2
-		2
20765	 <p>M8 x 15 mm</p>	4

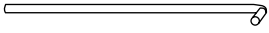
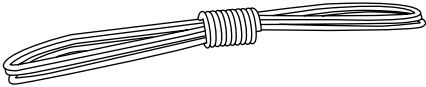
 **PAG-L2-Q4 3 m x 3 m**

Item no.		Q'ty
30046_E	 <p>Ø 6 x180 mm</p>	4
30047_E	 <p>Ø 4 x160 mm</p>	24
30050		4
30430_E		44
30051		4

 **PAG-L2-Q4 3 m x 3 m**

1

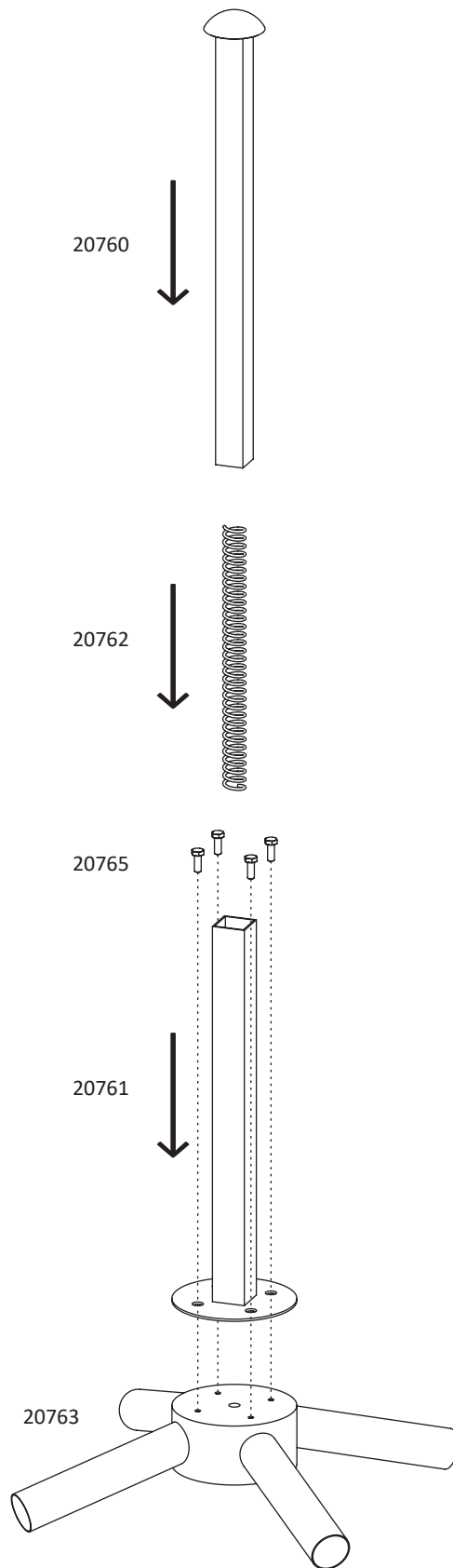

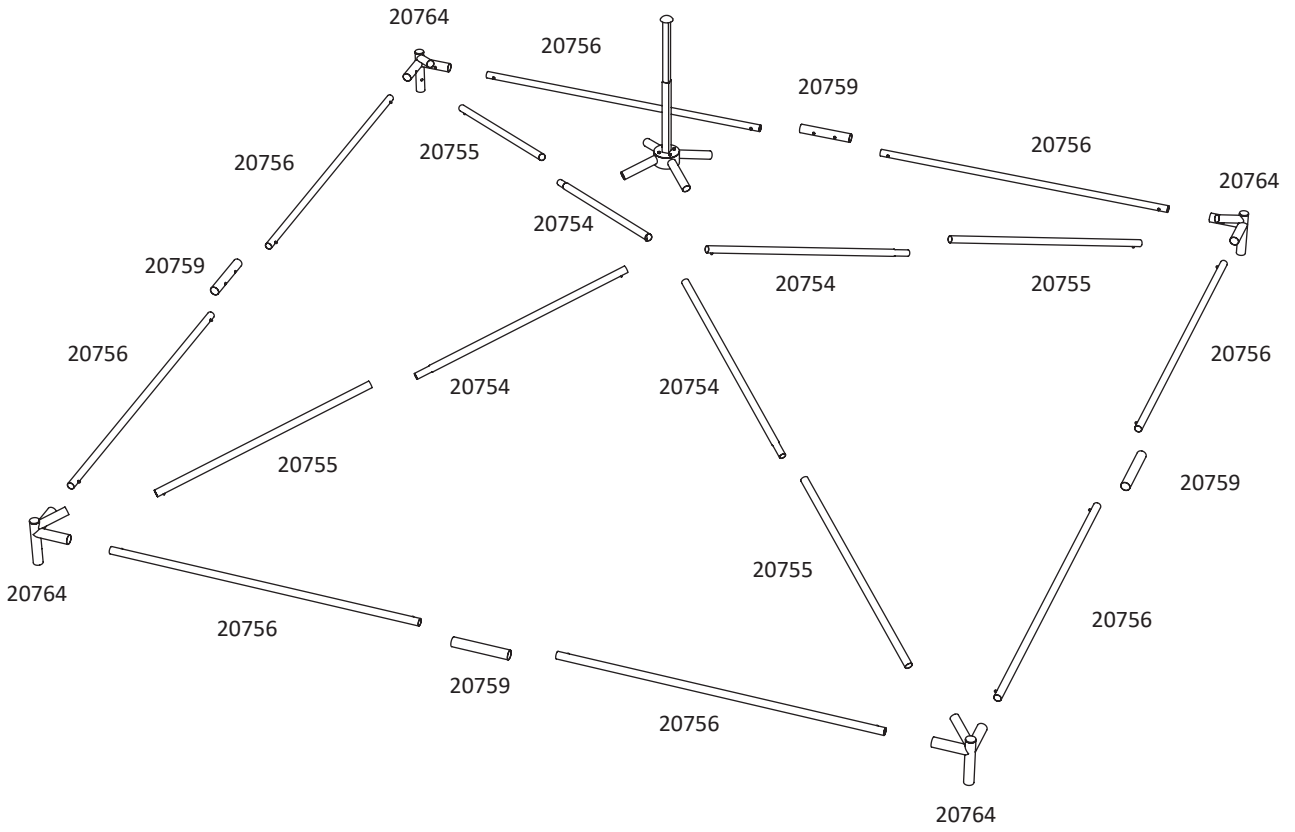

 **PAG-L2-Q4 3 m x 3 m**

2



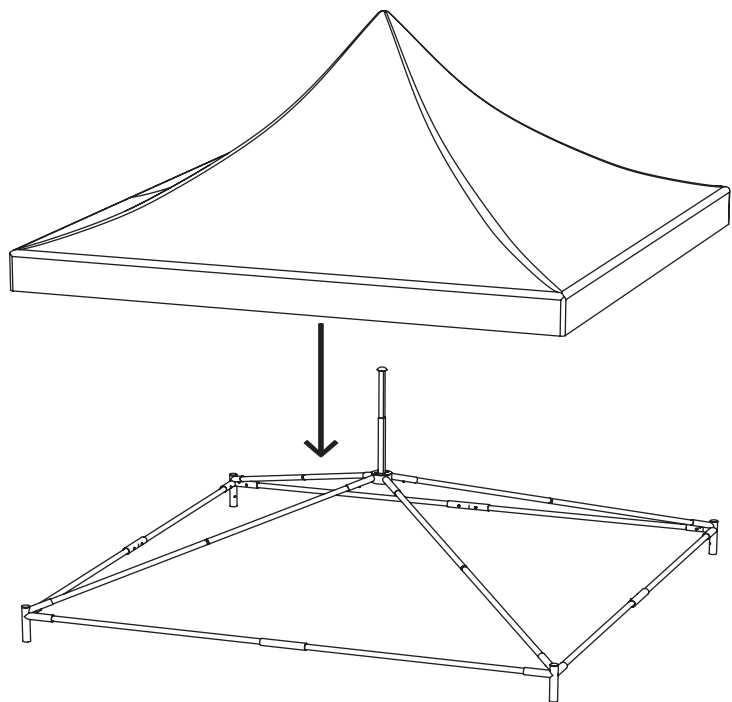

3

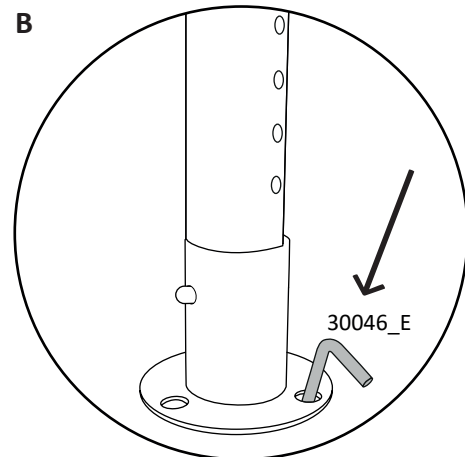
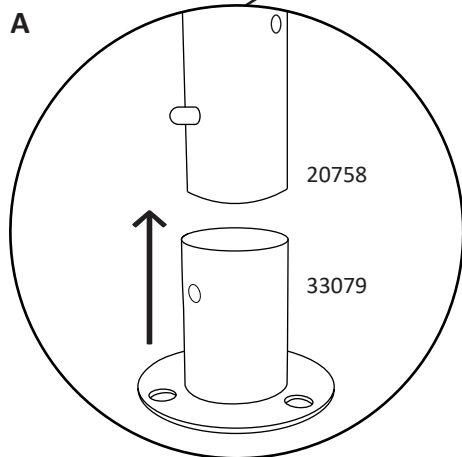
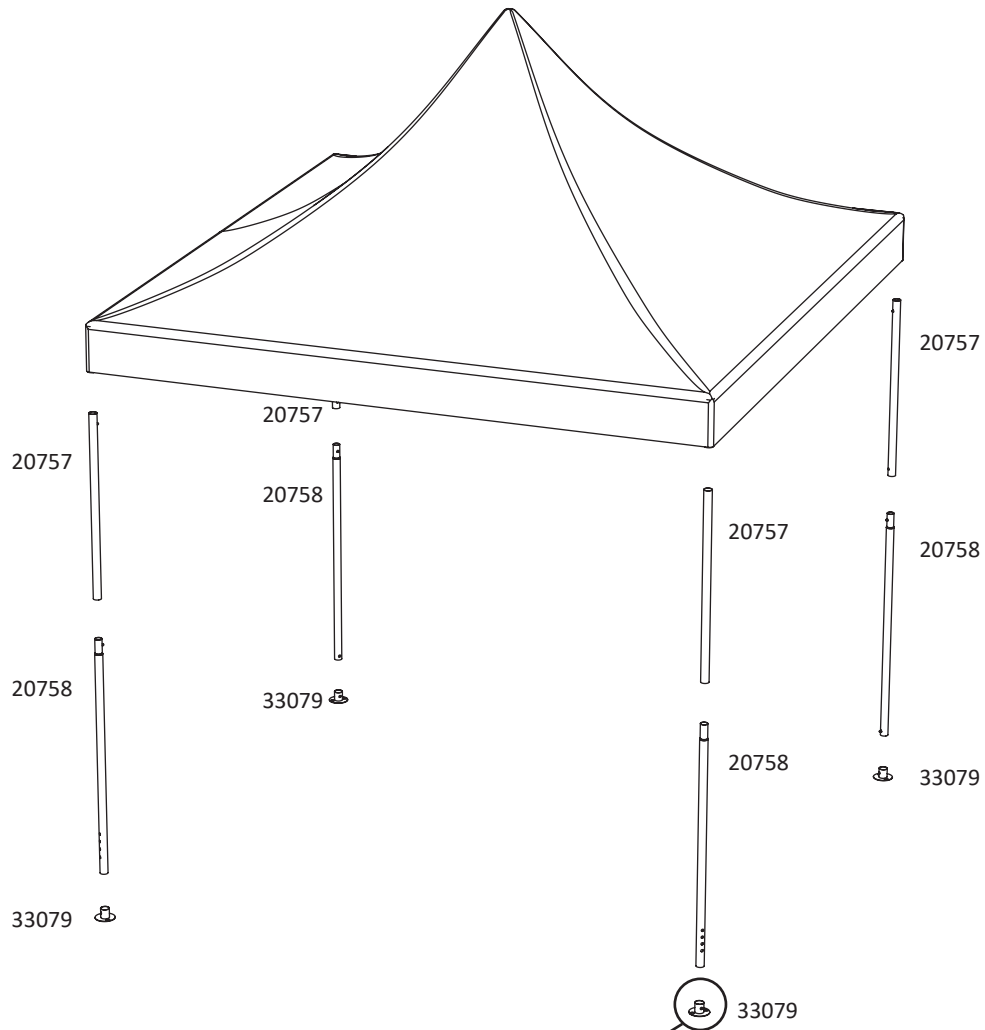

 **PAG-L2-Q4 3 m x 3 m**

4



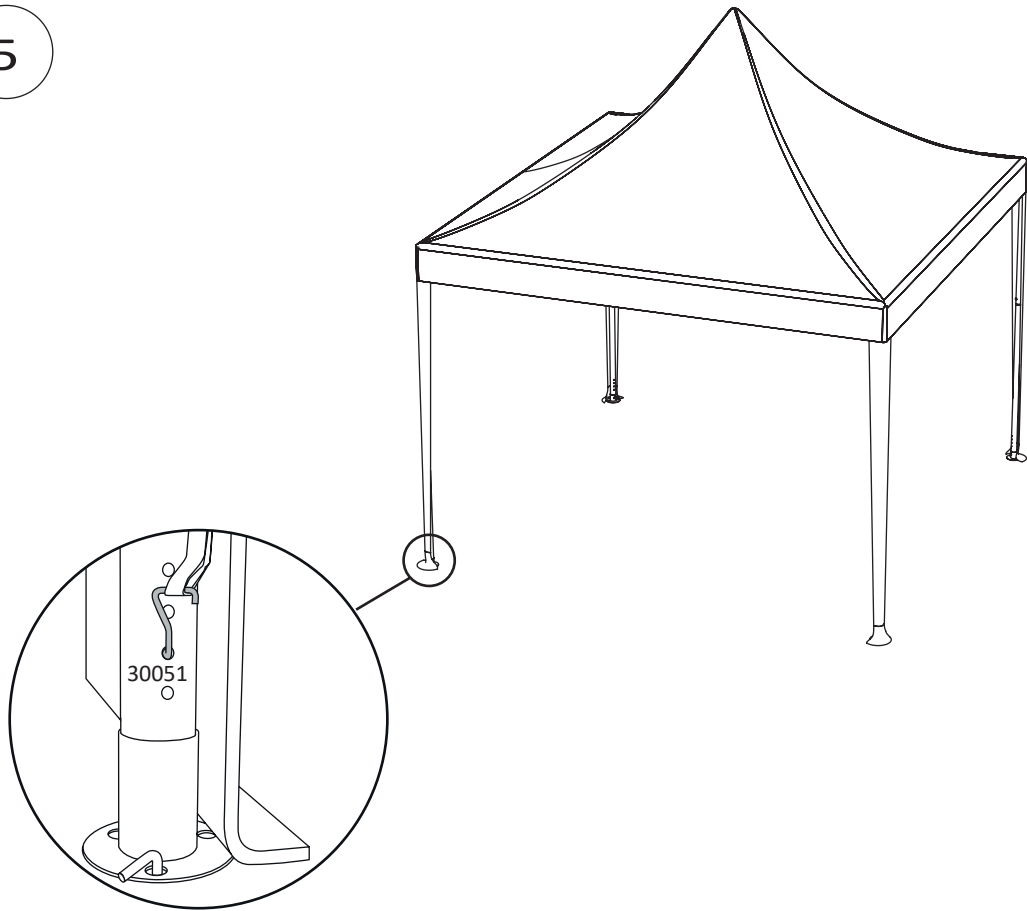

 **PAG-L2-Q4 3 m x 3 m**

5

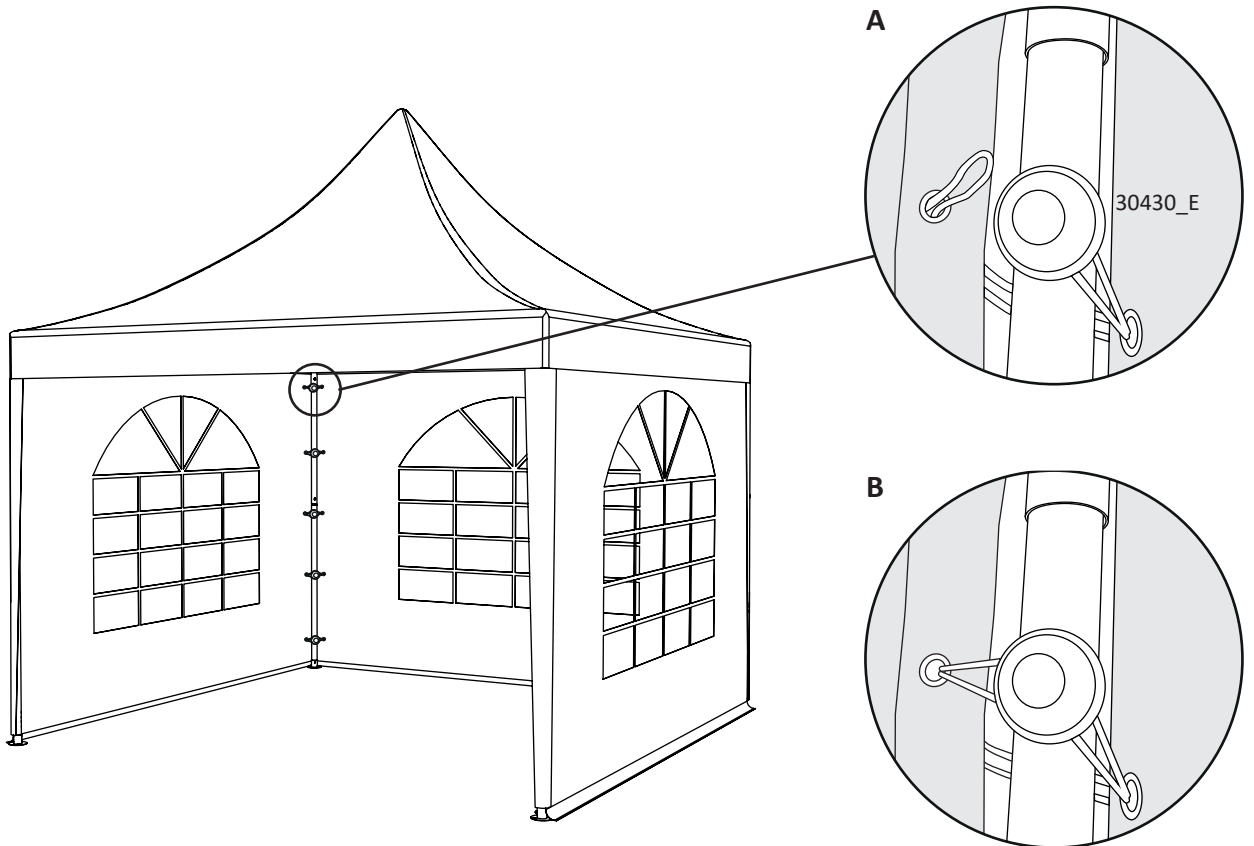

6



 **PAG-L2-Q4 3 m x 3 m**

7

