

 **PAG-L2-Q4** 4 m x 4 m

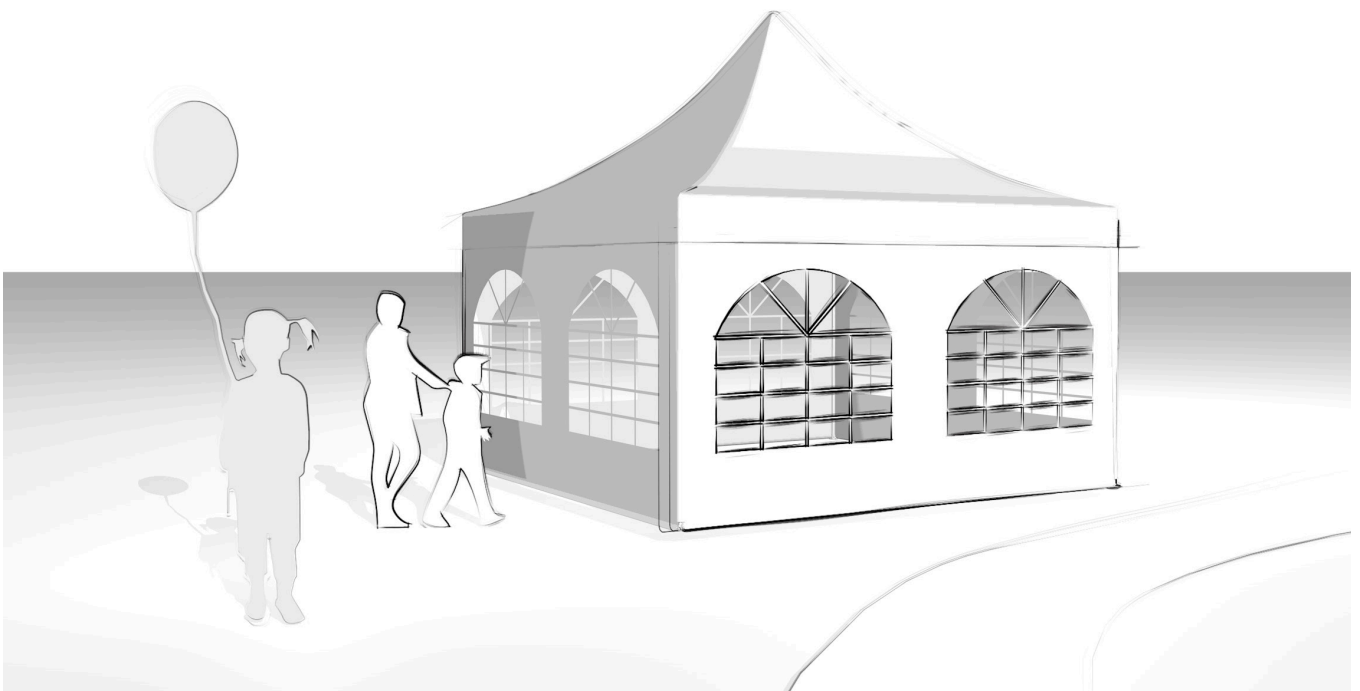

01/2025-02

TOOLPORT

 **PAG-L2-Q4 4 m x 4 m**

A

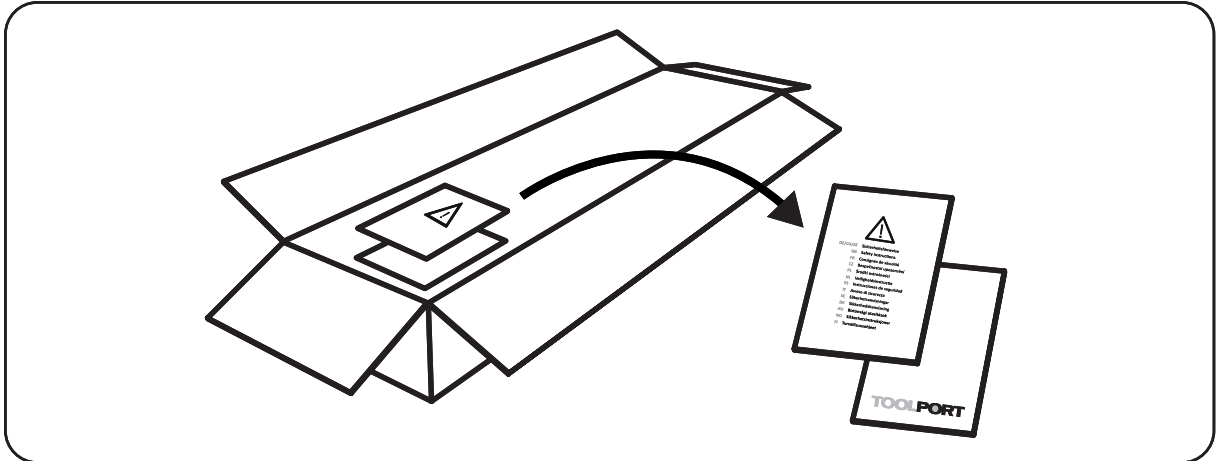



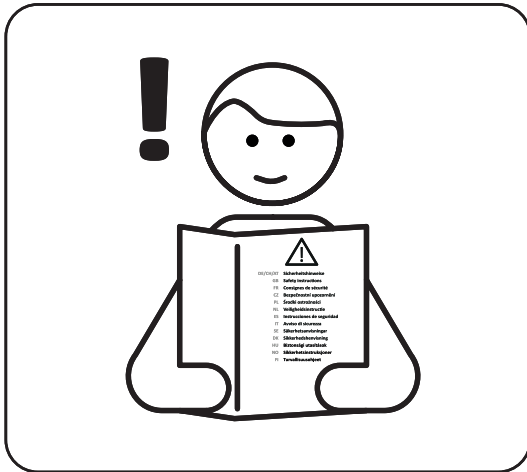



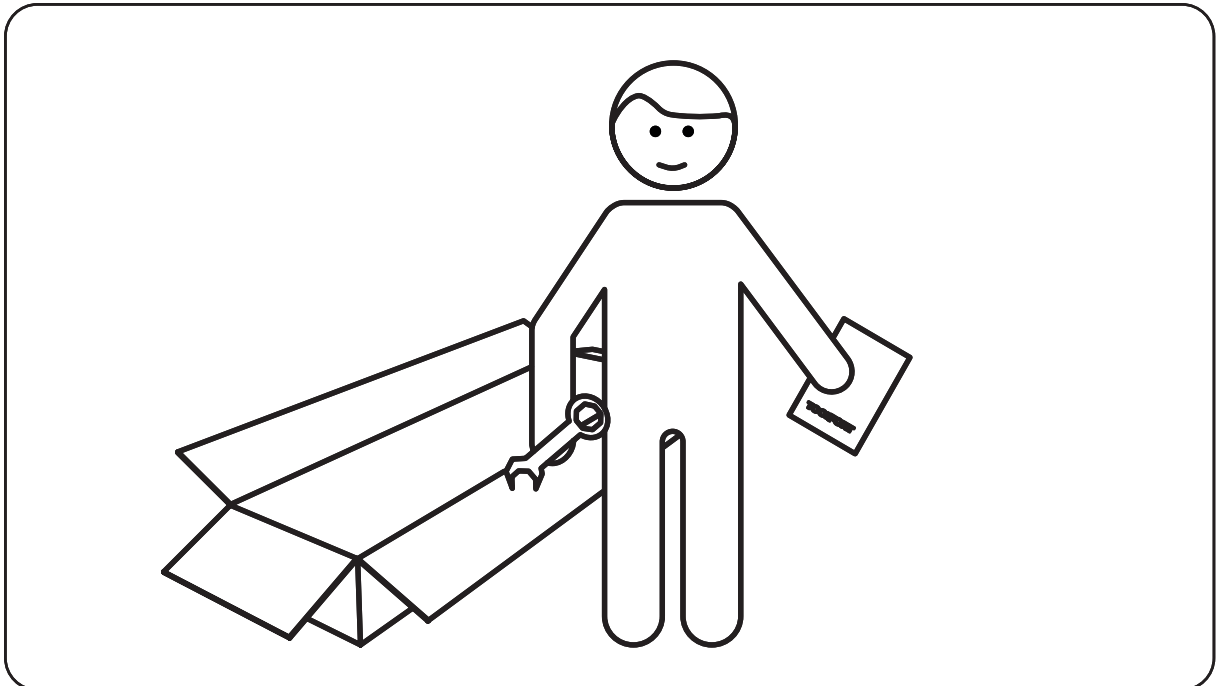

B

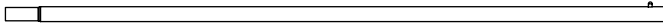
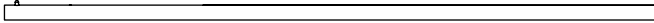
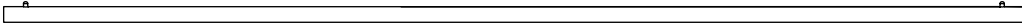
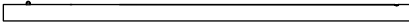
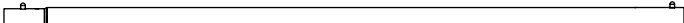

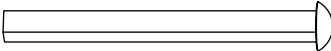
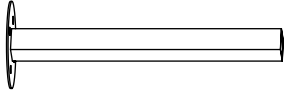

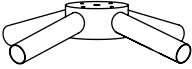

C

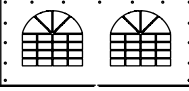
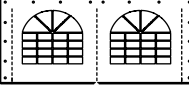
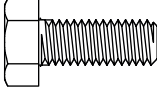

 **PAG-L2-Q4 4 m x 4 m**

Item no.		Q'ty
20769	 Ø 32 x 1410 mm	4
20770	 Ø 32 x 1407 mm	4
20771	 Ø 38 x 1860 mm	8
20757	 Ø 38 x 905 mm	4
20758	 Ø 38 x 1182 mm	4
20772	 Ø 41 x 365 mm	4
20760		1
20761		1
20764		4
20763		1
33079		4
30762		1
-		1
-		2
-		2
20765	M8 x 15 mm 	4

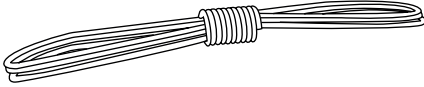
 **PAG-L2-Q4 4 m x 4 m**

Item no.		Q'ty
30046_E	 <p>∅ 6 x180 mm</p>	4
30047_E	 <p>∅ 4 x160 mm</p>	30
30050		4
30430_E		54
30051		4

 **PAG-L2-Q4** 4 m x 4 m

1

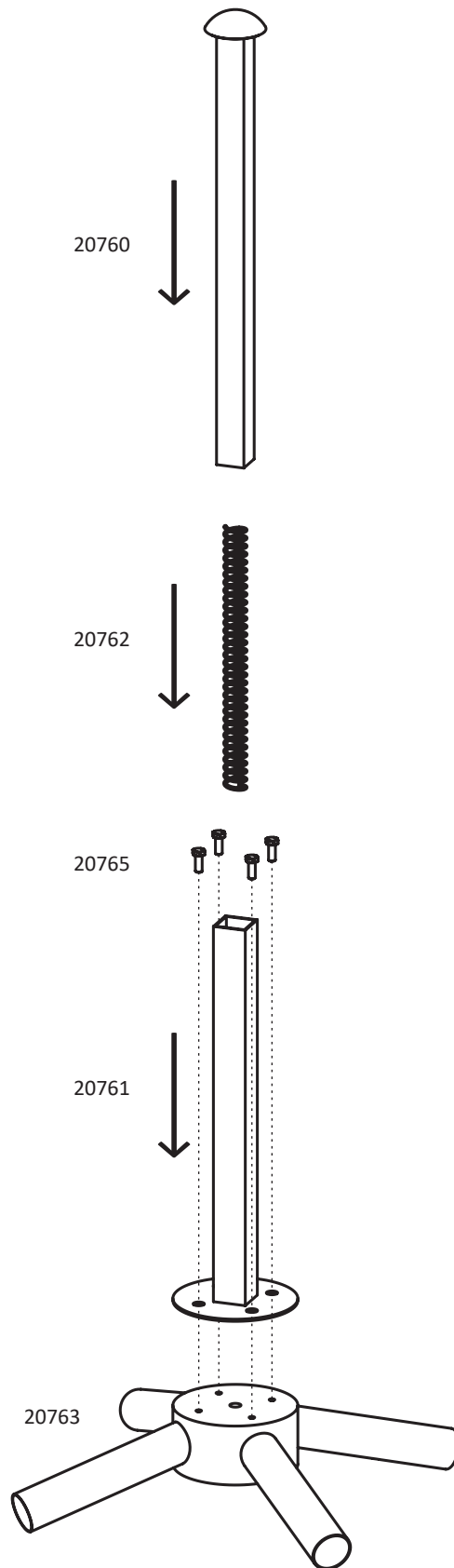

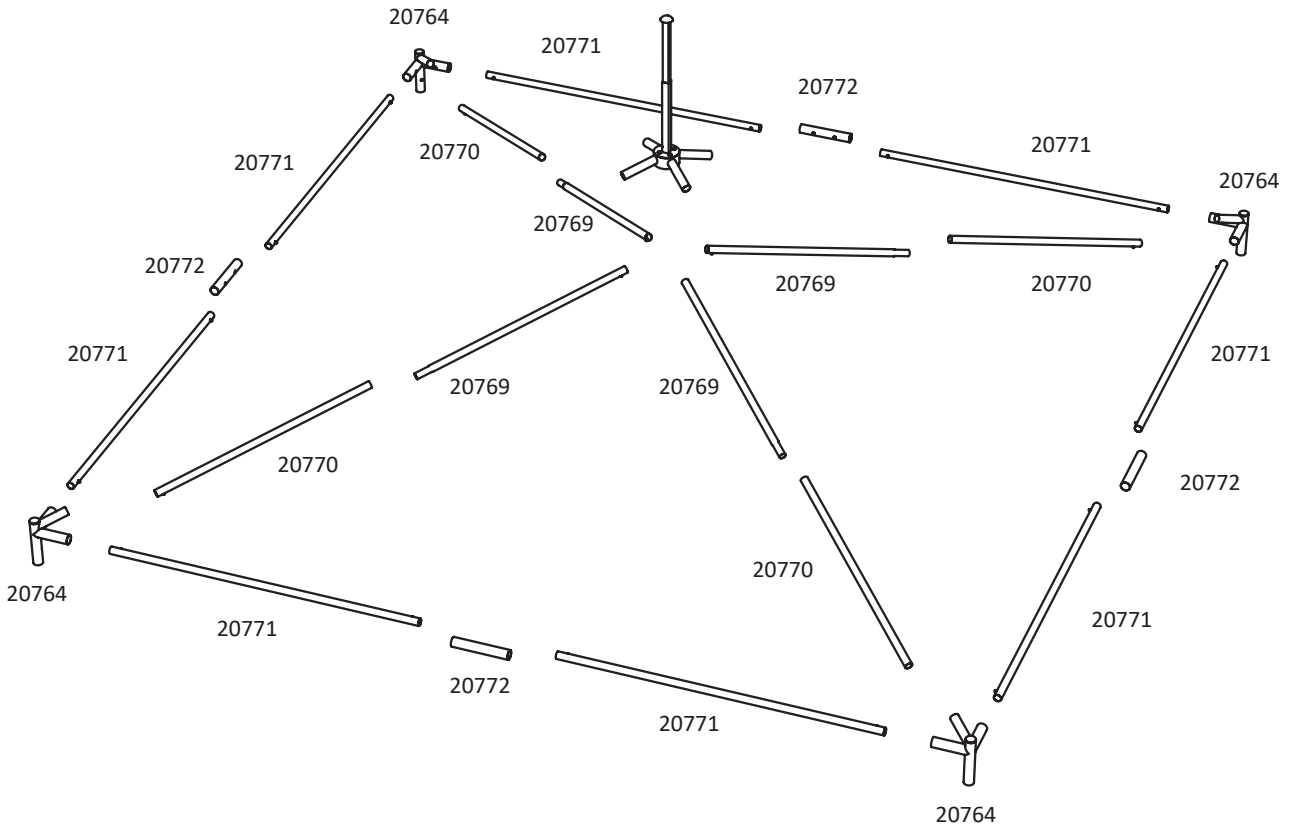

 **PAG-L2-Q4 4 m x 4 m**

2



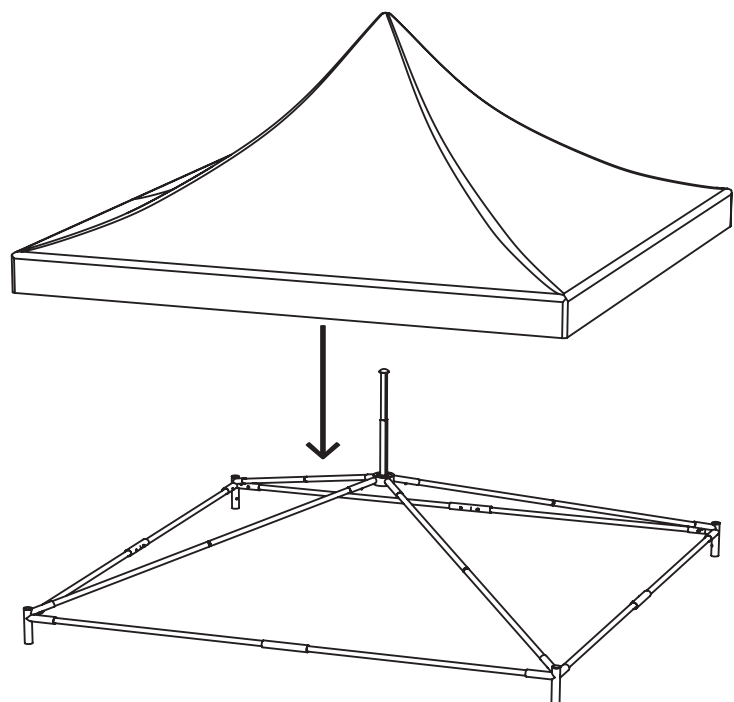

3

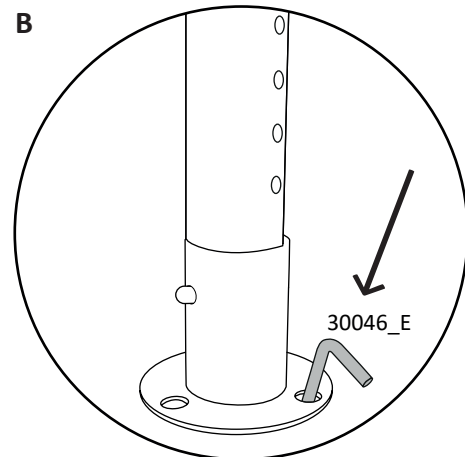
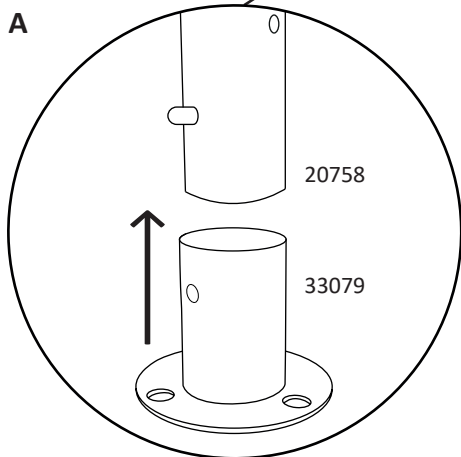
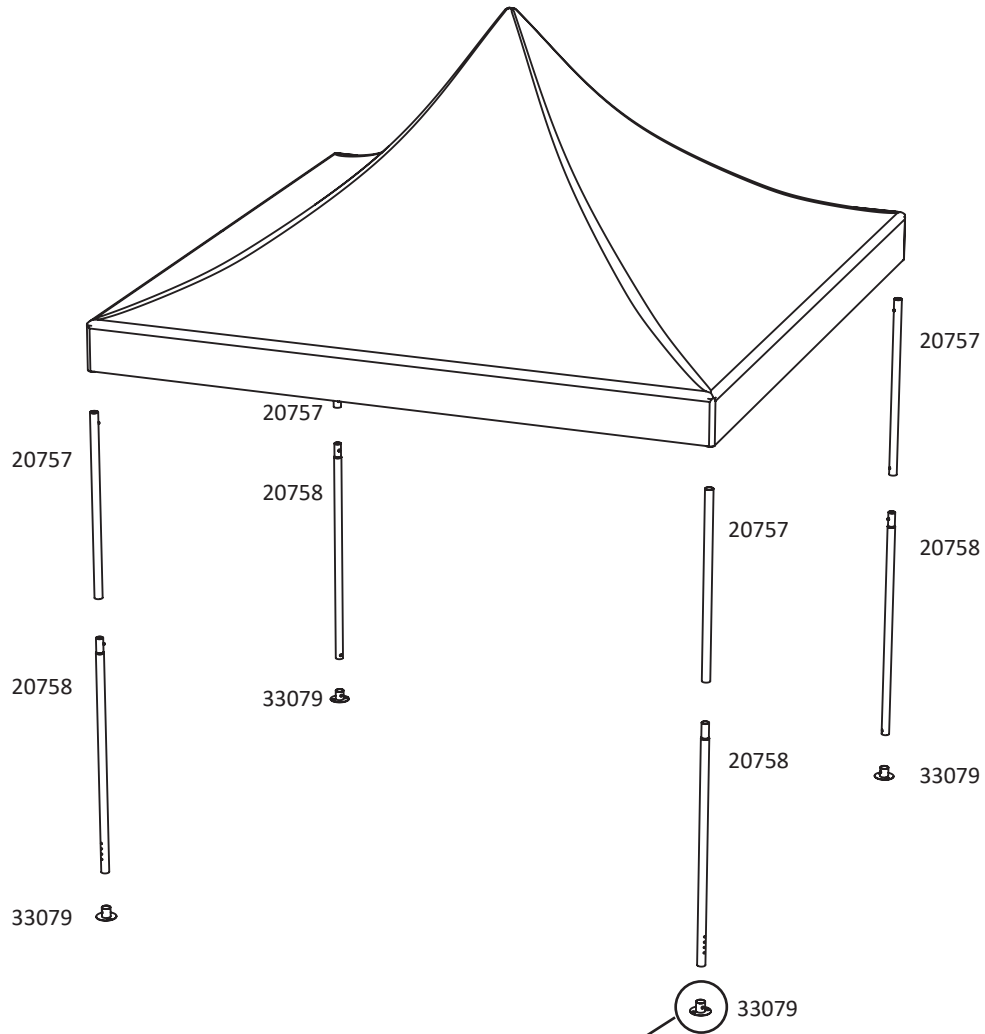

 **PAG-L2-Q4 4 m x 4 m**

4



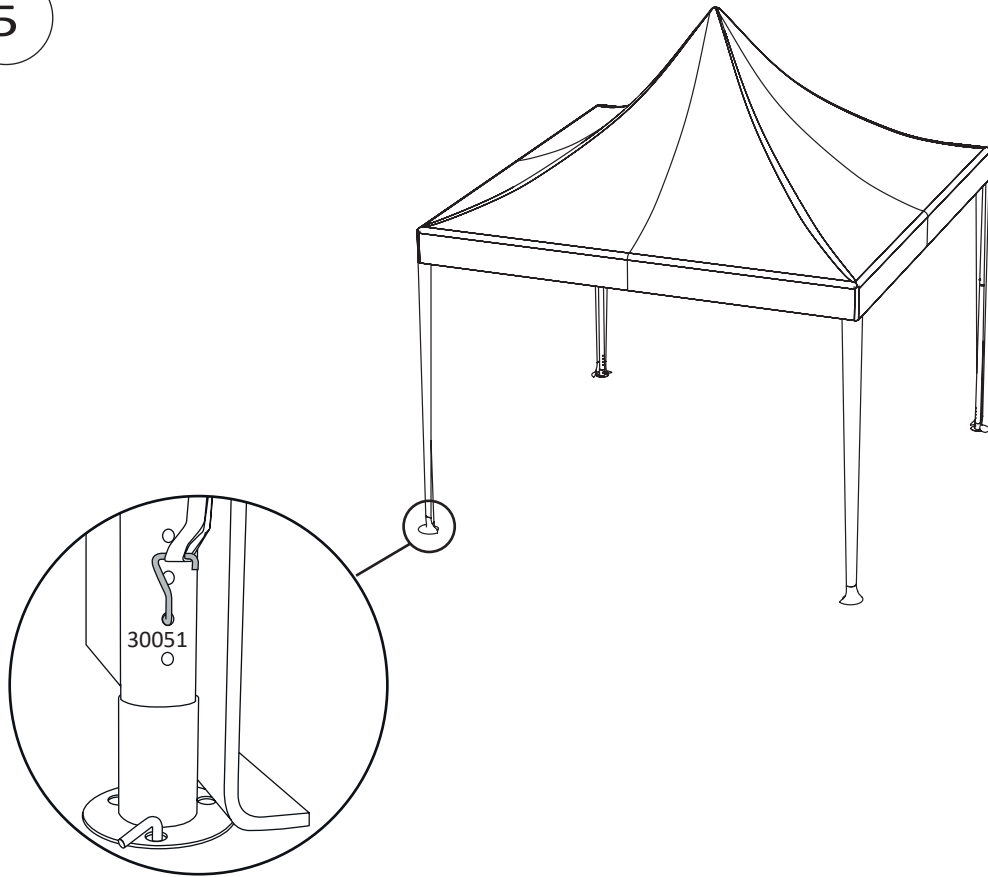

 **PAG-L2-Q4 4 m x 4 m**

5

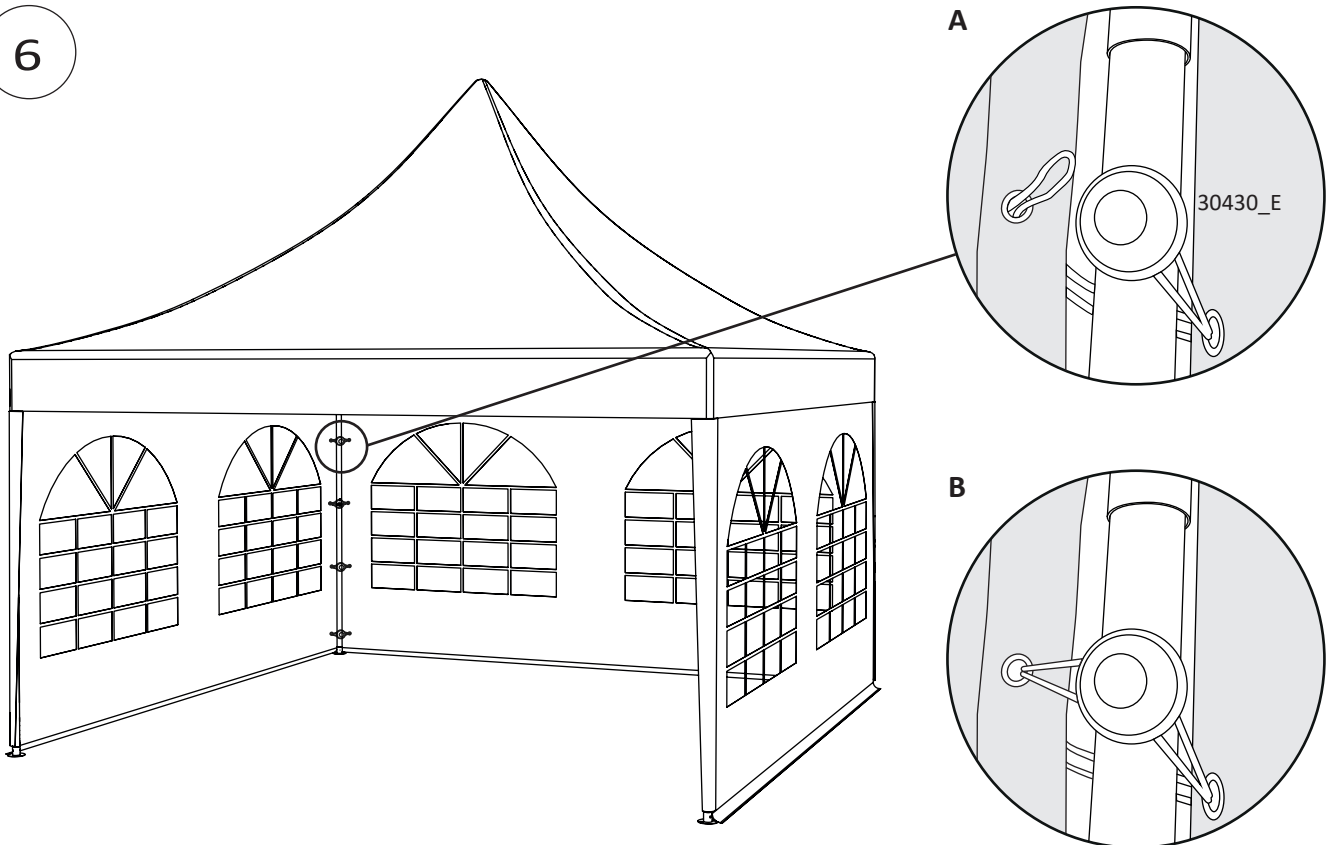

6



 **PAG-L2-Q4 4 m x 4 m**

7

