

 **PAG-L2-Q4** 4 m x 5,5 m

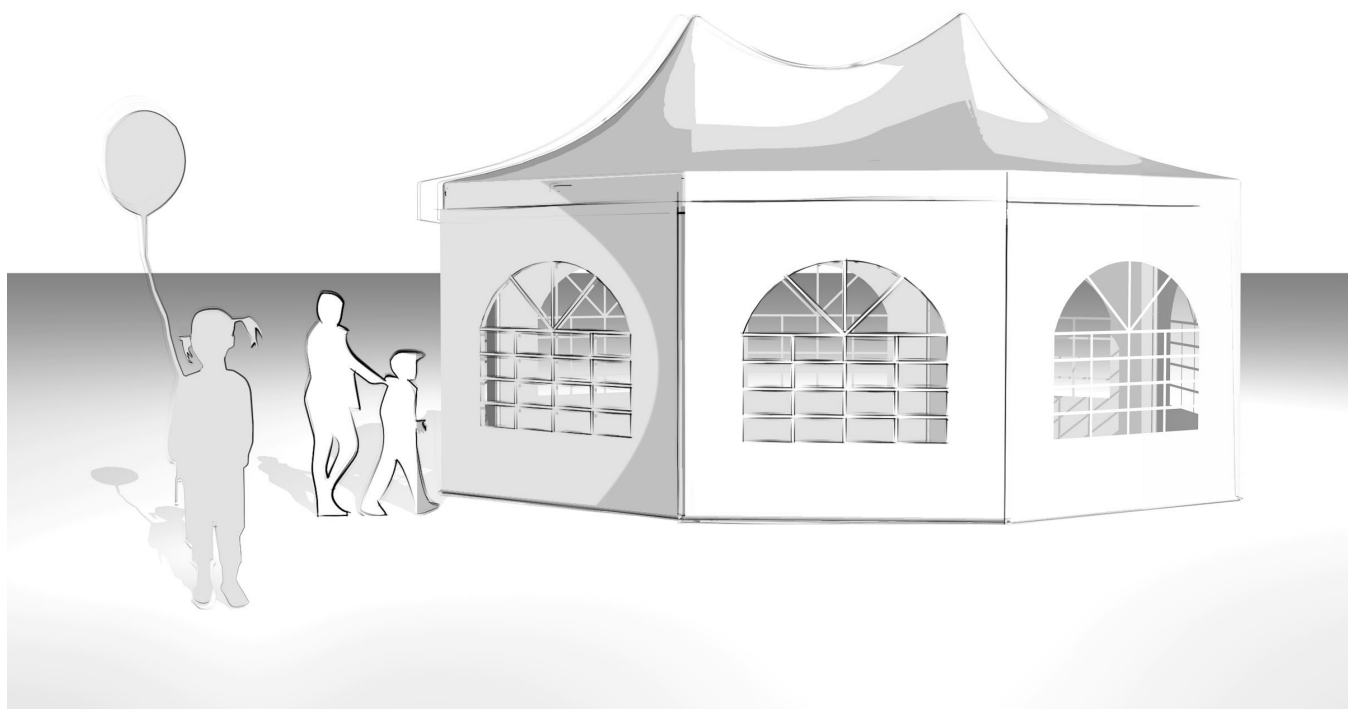

01/2025-02

TOOLPORT

 **PAG-L2-Q4 4 m x 5,5 m**

A

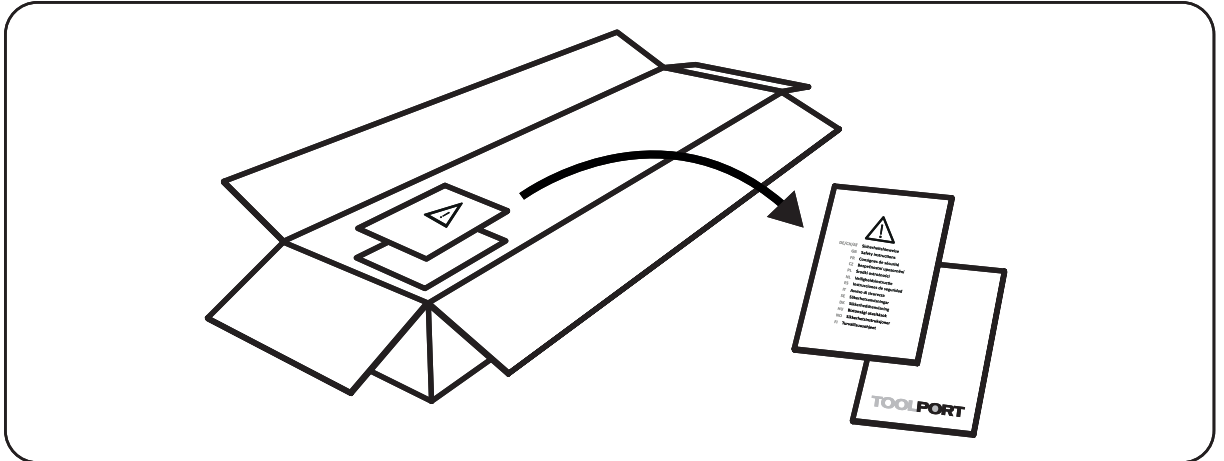



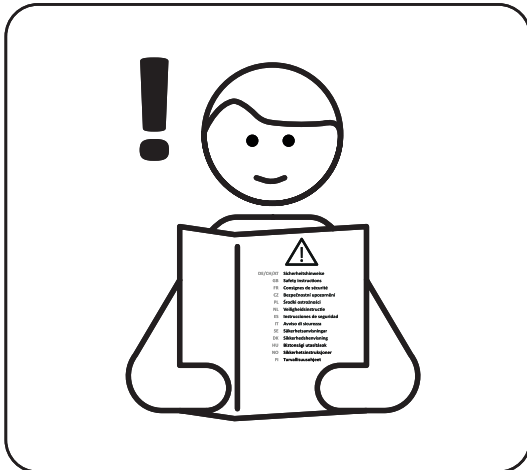



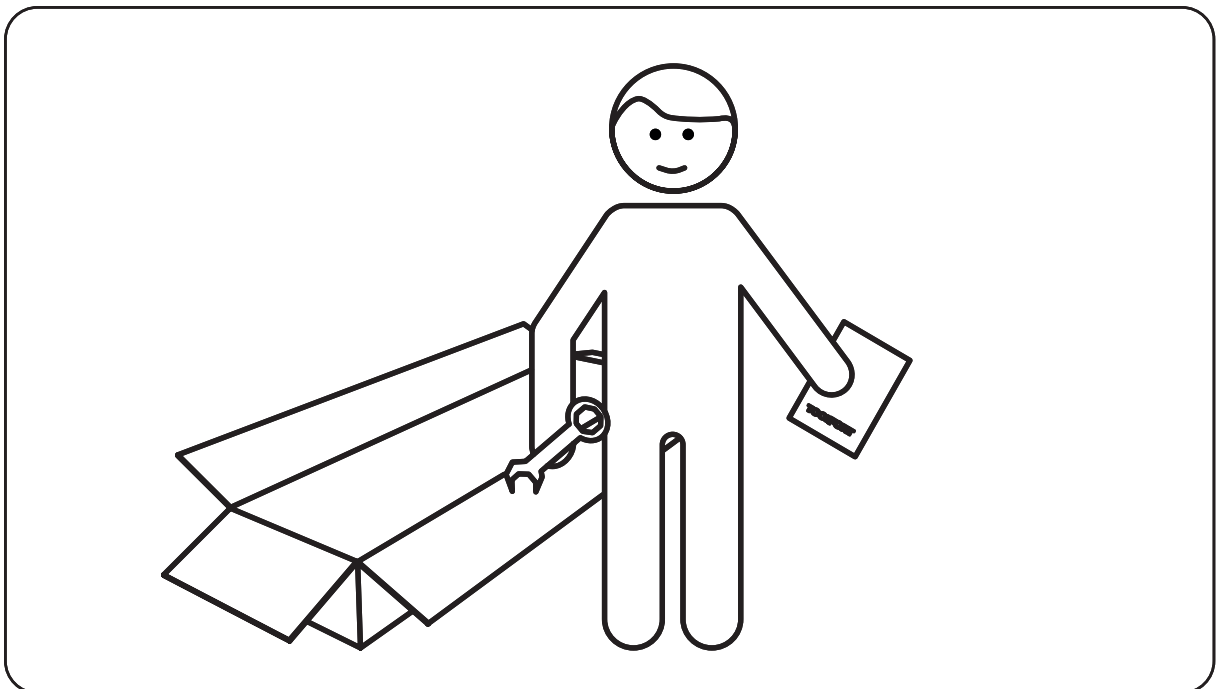

B

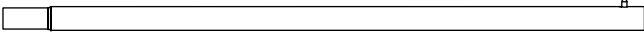
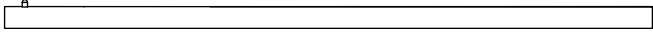
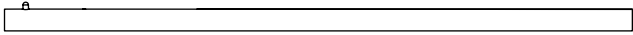
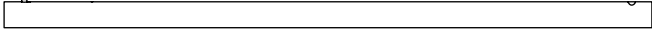
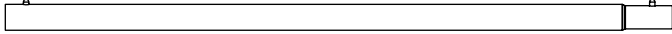
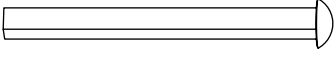
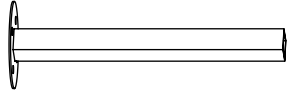

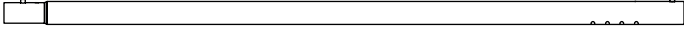

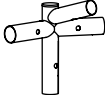

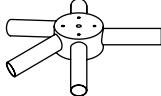

C

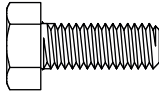
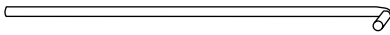

 **PAG-L2-Q4 4 m x 5,5 m**

Item no.		Q'ty
20798	 Ø 32 x 993 mm	9
20799	 Ø 32 x 990 mm	8
20800	 Ø 32 x 918 mm	1
20801	 Ø 38x 992 mm	8
20802	 Ø 38 x 995 mm	8
20790		2
20761		2
20757	 Ø 38 x 905 mm	8
20758	 Ø 38 x 1182 mm	8
20791		4
20792		2
20793		2
33079		8
20794		2
-		1
-		6

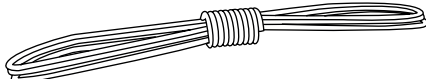
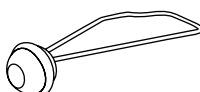
 **PAG-L2-Q4 4 m x 5,5 m**

Item no.		Q'ty
-		2
20765	M8 x 15 mm 	8
30046_E	∅ 6 x180 mm 	8
30047_E	∅ 4 x160 mm 	36
30050		8
30430_E		76
30051		8
20762		2

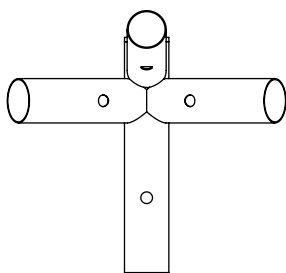

20791

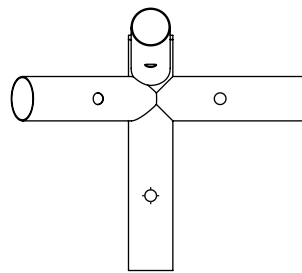

20792

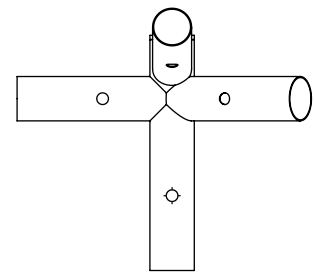

20793

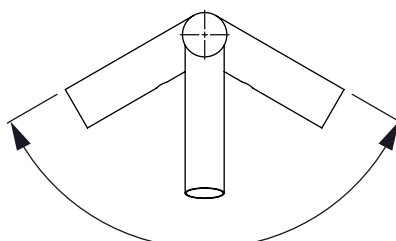

120°

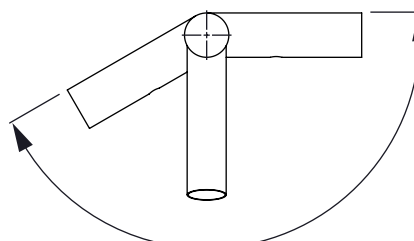

150°

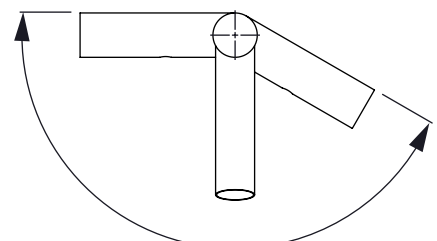



150°

 **PAG-L2-Q4 4 m x 5,5 m**

1

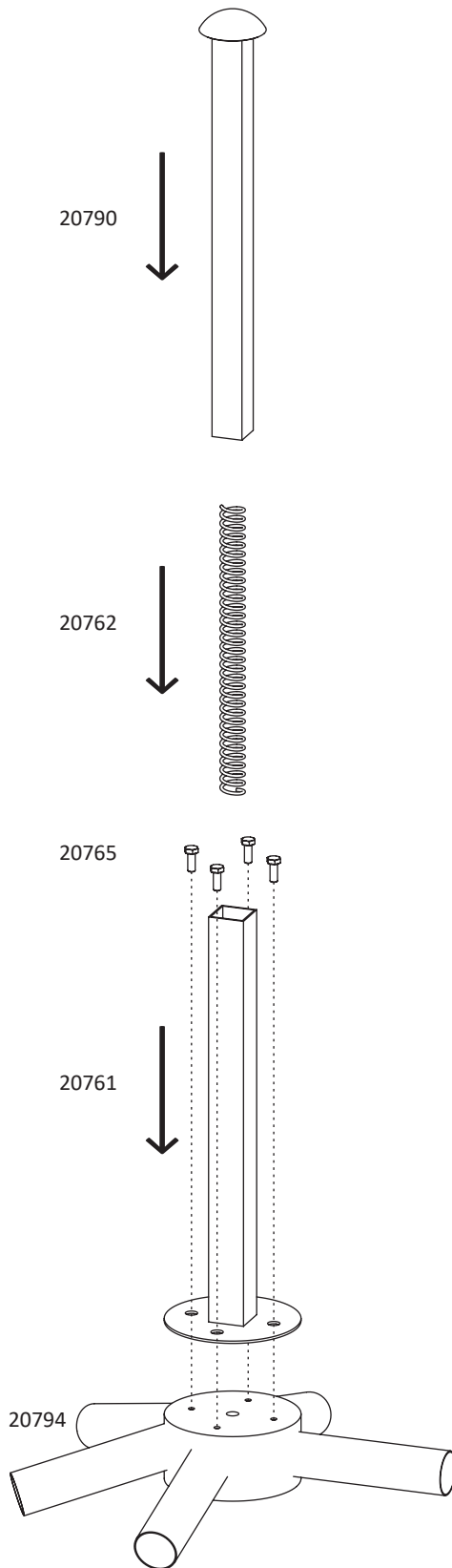
2x



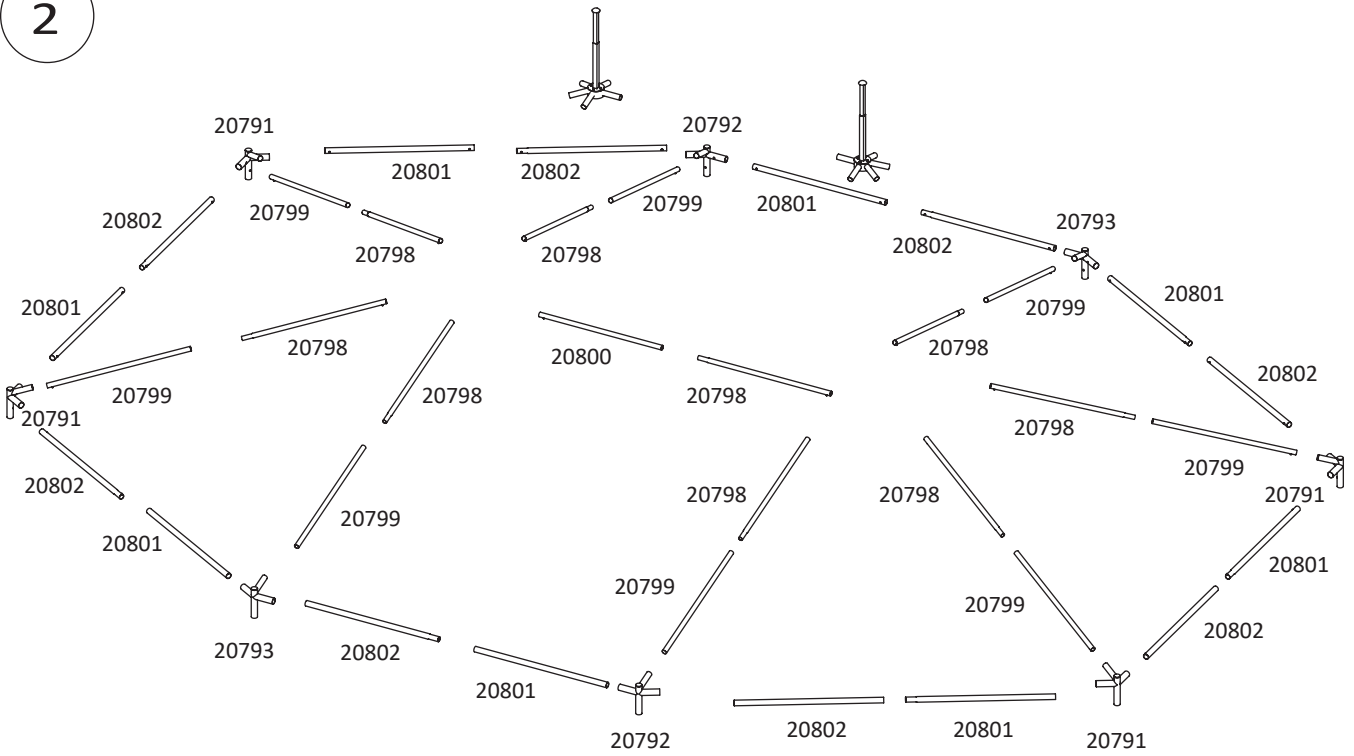

 **PAG-L2-Q4 4 m x 5,5 m**

2



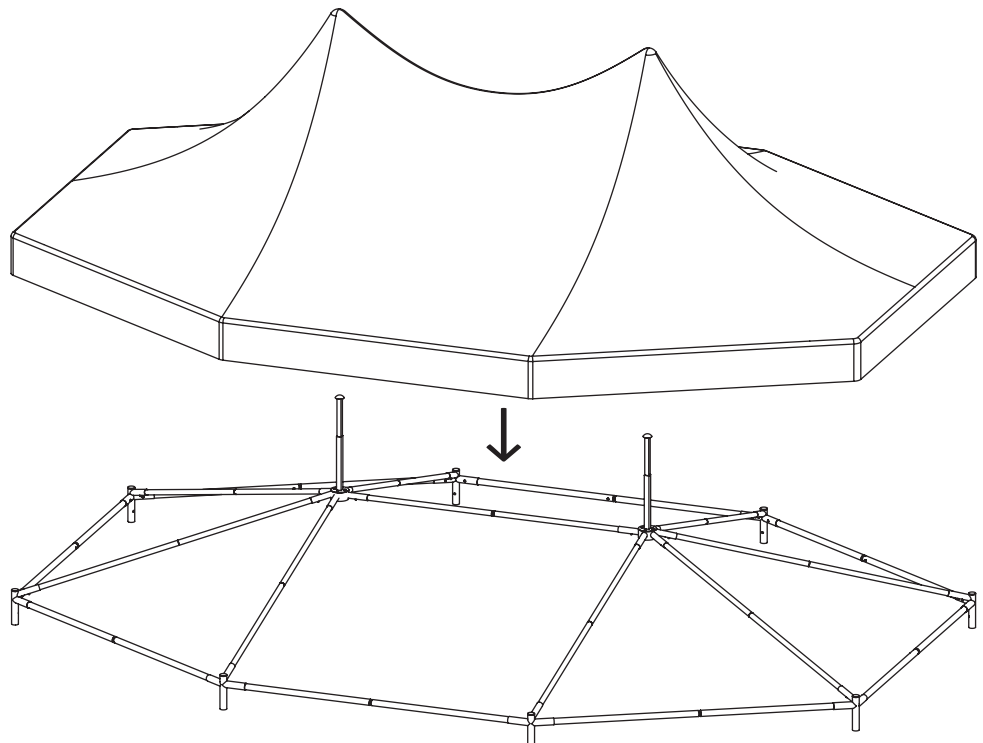

3

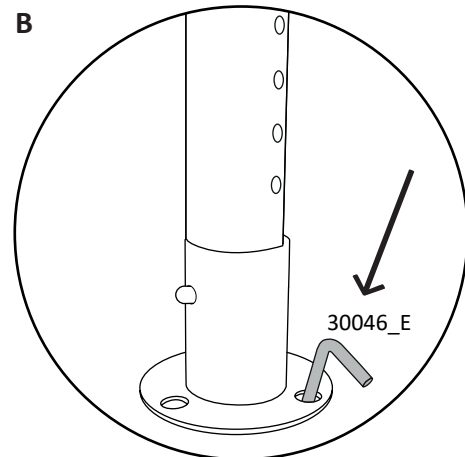
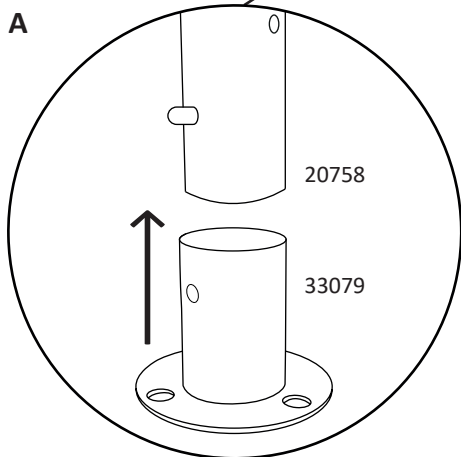
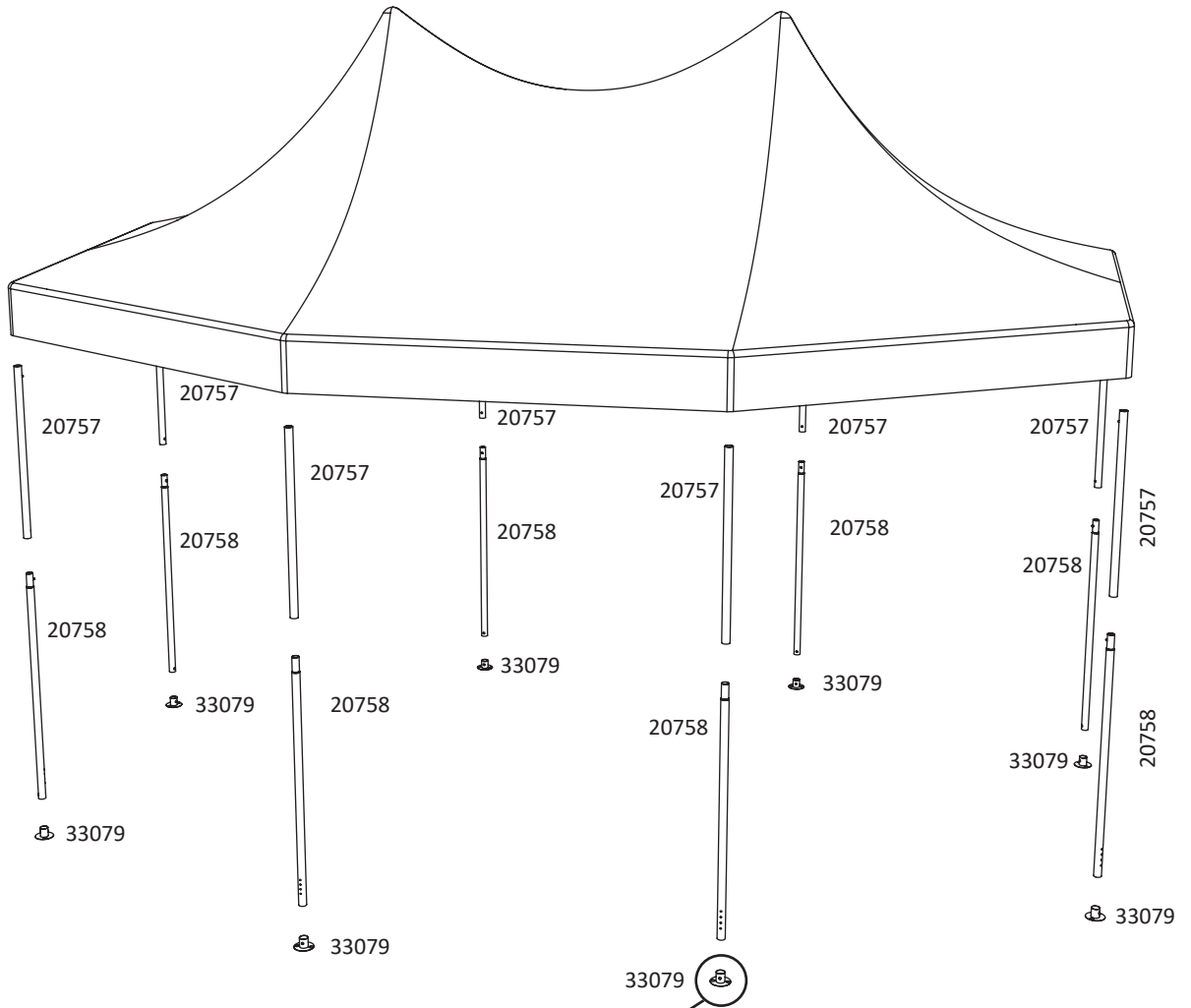

 **PAG-L2-Q4 4 m x 5,5 m**

4



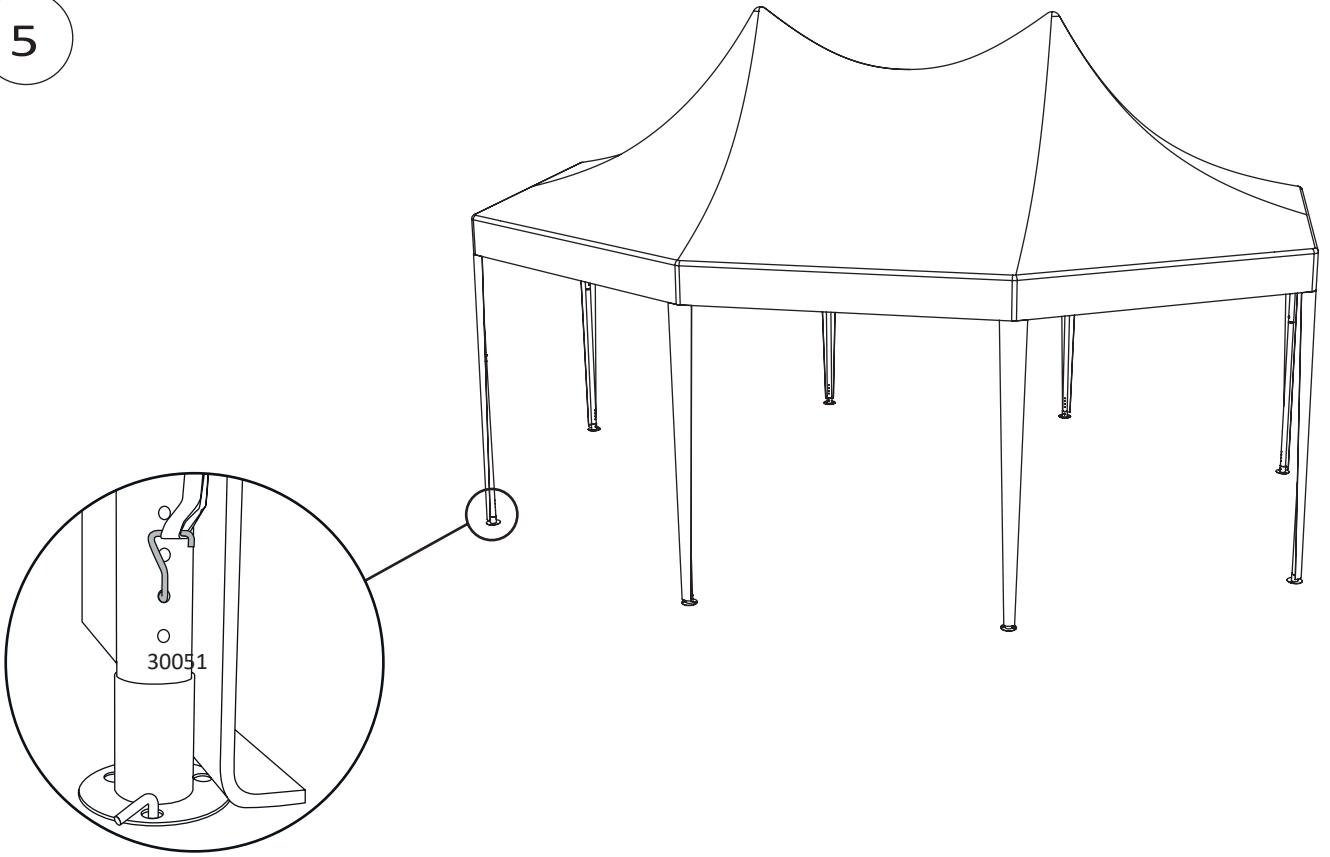

 **PAG-L2-Q4 4 m x 5,5 m**

5

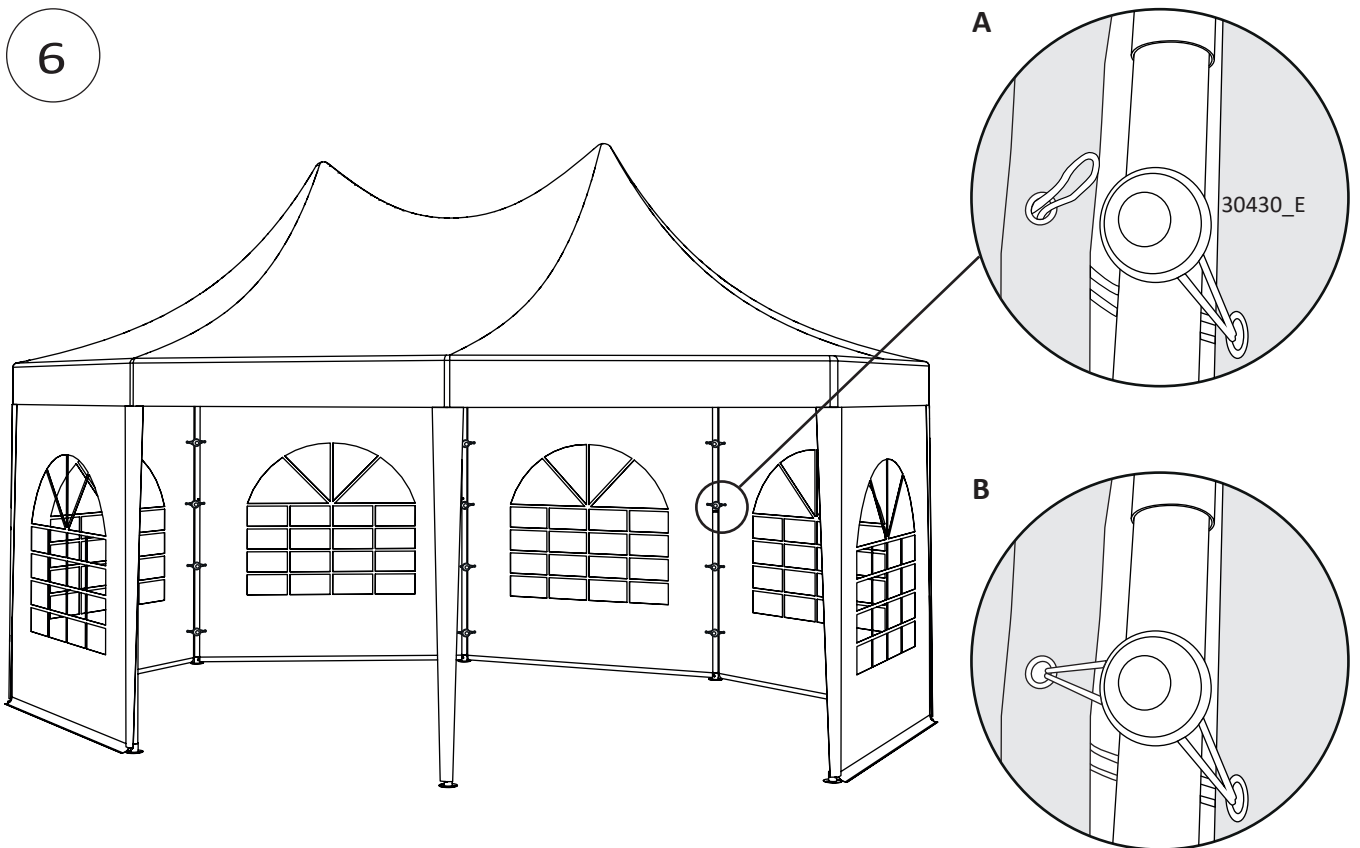

6



 **PAG-L2-Q4 4 m x 5,5 m**

7

