

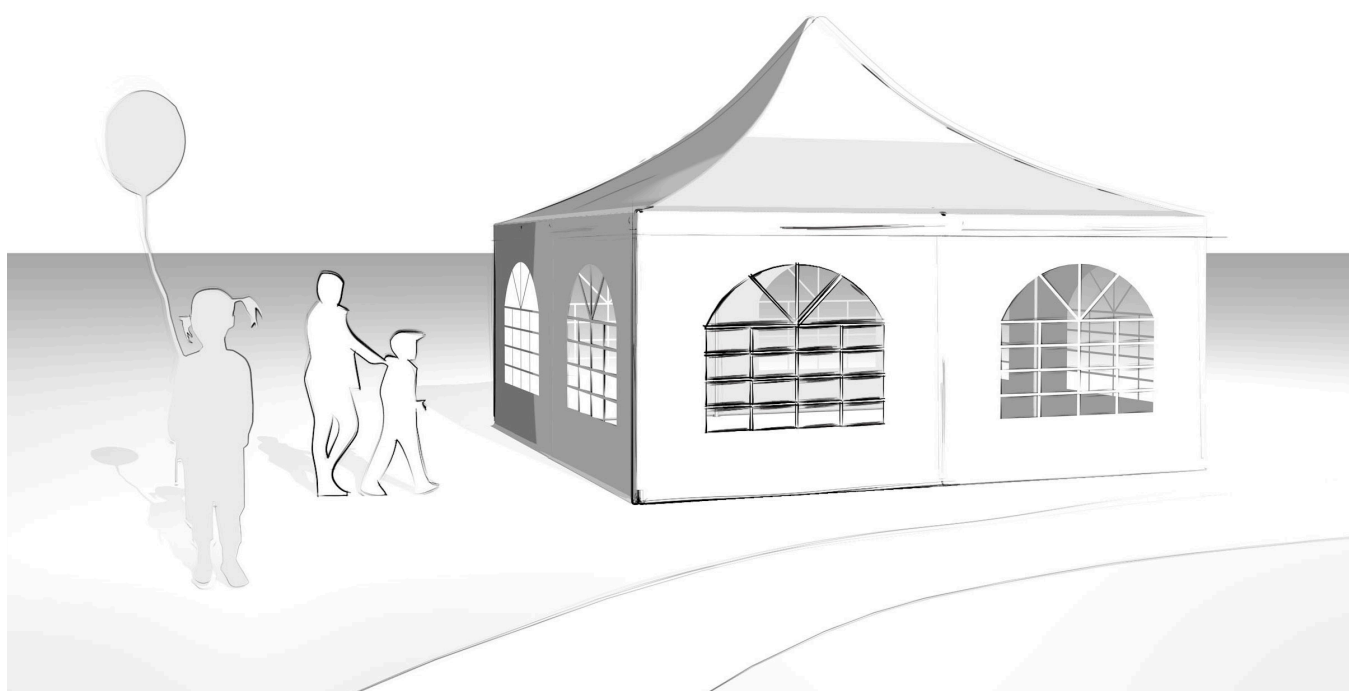

 **PAG-L2-Q4** 5 m x 5 m



01/2025-02

TOOLPORT

 **PAG-L2-Q4 5 m x 5 m**

A

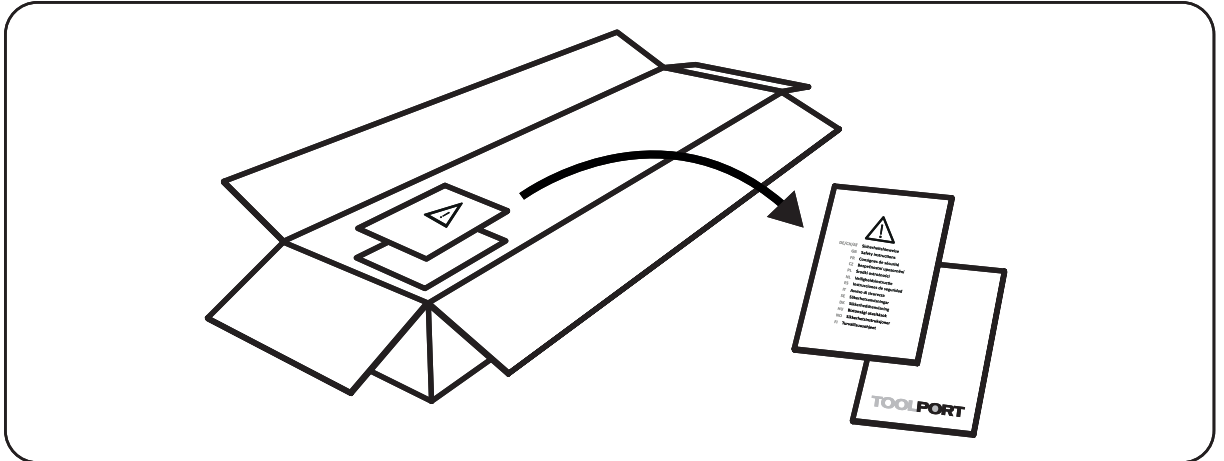



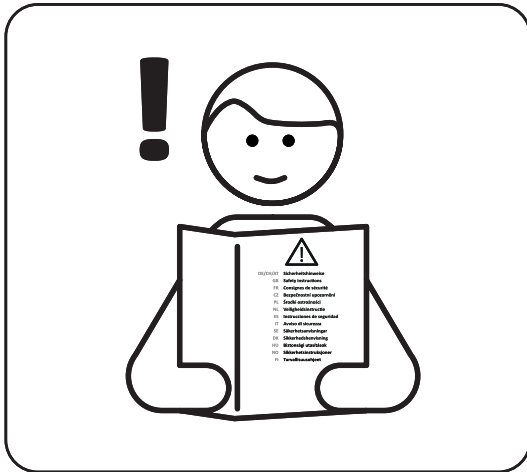



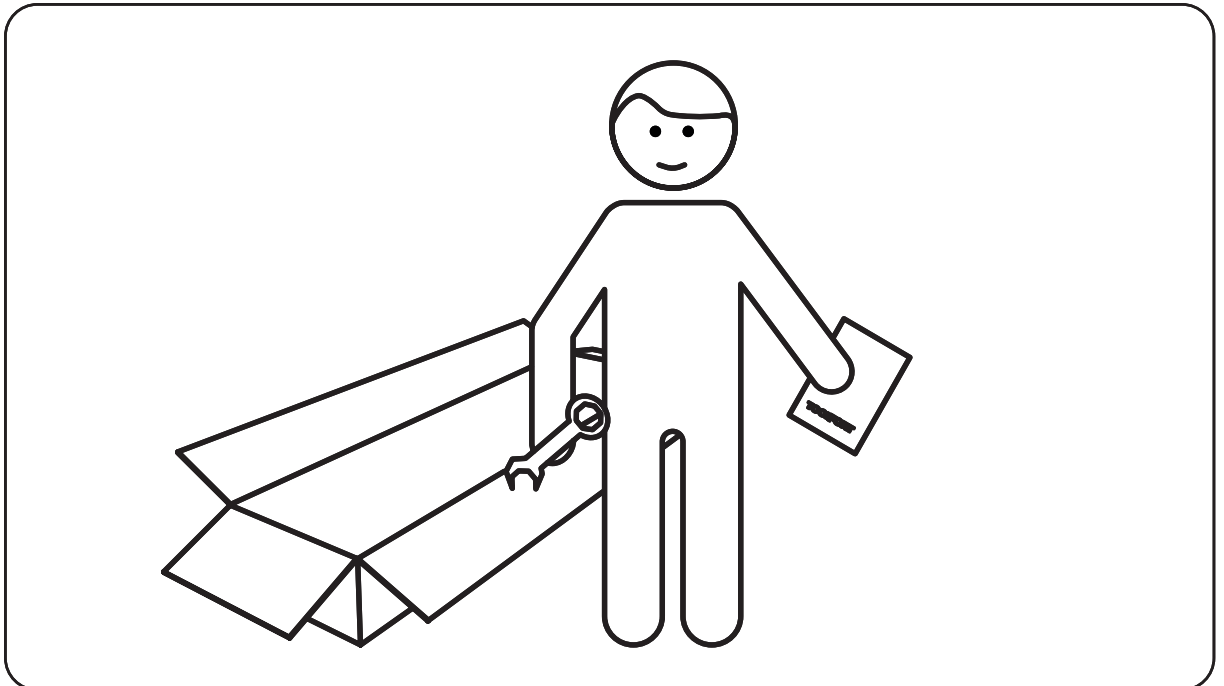

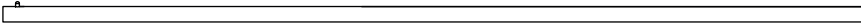
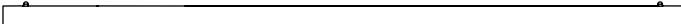

B

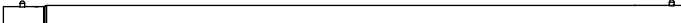
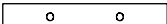
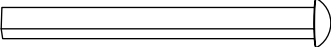
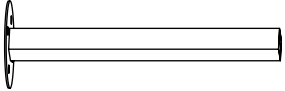



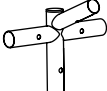

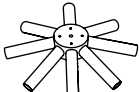
C

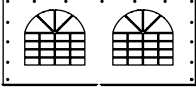
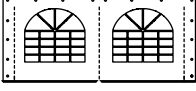
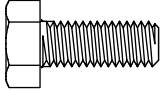

 **PAG-L2-Q4 5 m x 5 m**

Item no.		Q'ty
20776	 Ø 32 x 1773 mm	4
20777	 Ø 32 x 1770 mm	4
20778	 Ø 38 x 1188 mm	16
20757	 Ø 38 x 905 mm	8
20758	 Ø 38 x 1182 mm	8
20759	 Ø 41 x 250 mm	8
20779		1
20761		1
20782	 Ø 32 x 1283 mm	4
20783	 Ø 32 x 1280 mm	4
20764		4
20780		4
33079		8
20781		1
20762		1
		1

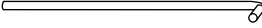
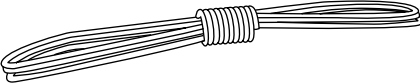
 **PAG-L2-Q4 5 m x 5 m**

Item no.		Q'ty
		2
		2
20765	M8 x 15 mm 	4
30046_E	 Ø 6 x 180 mm	4
30047_E	 Ø 4 x 160 mm	32
30050		8
30430_E		60
30051		8

 **PAG-L2-Q4 5 m x 5 m**

1

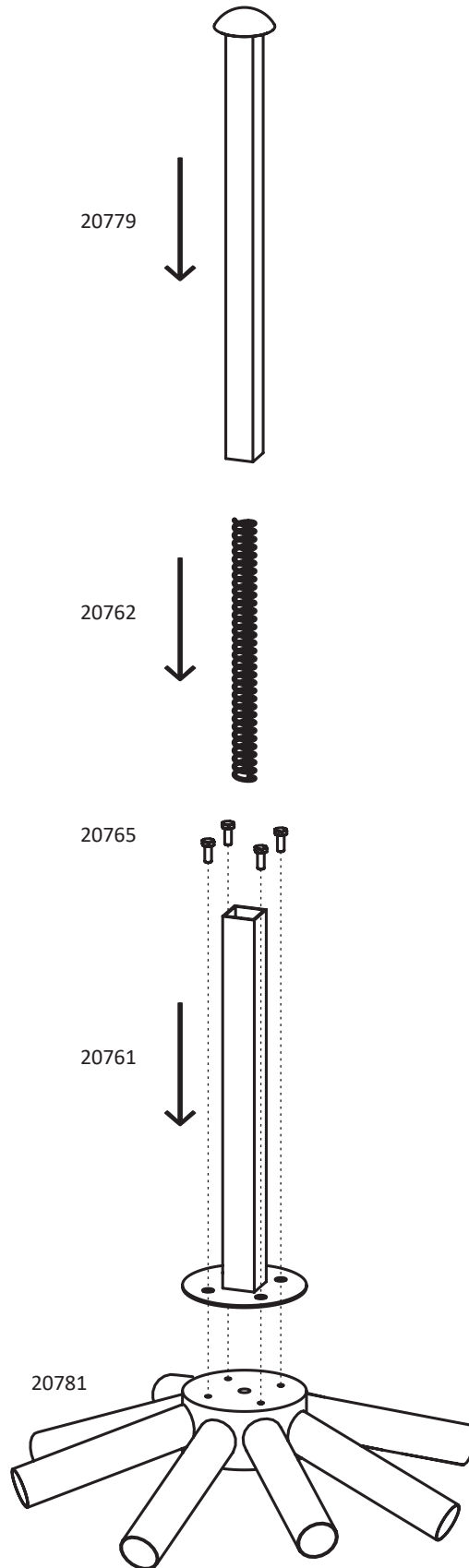

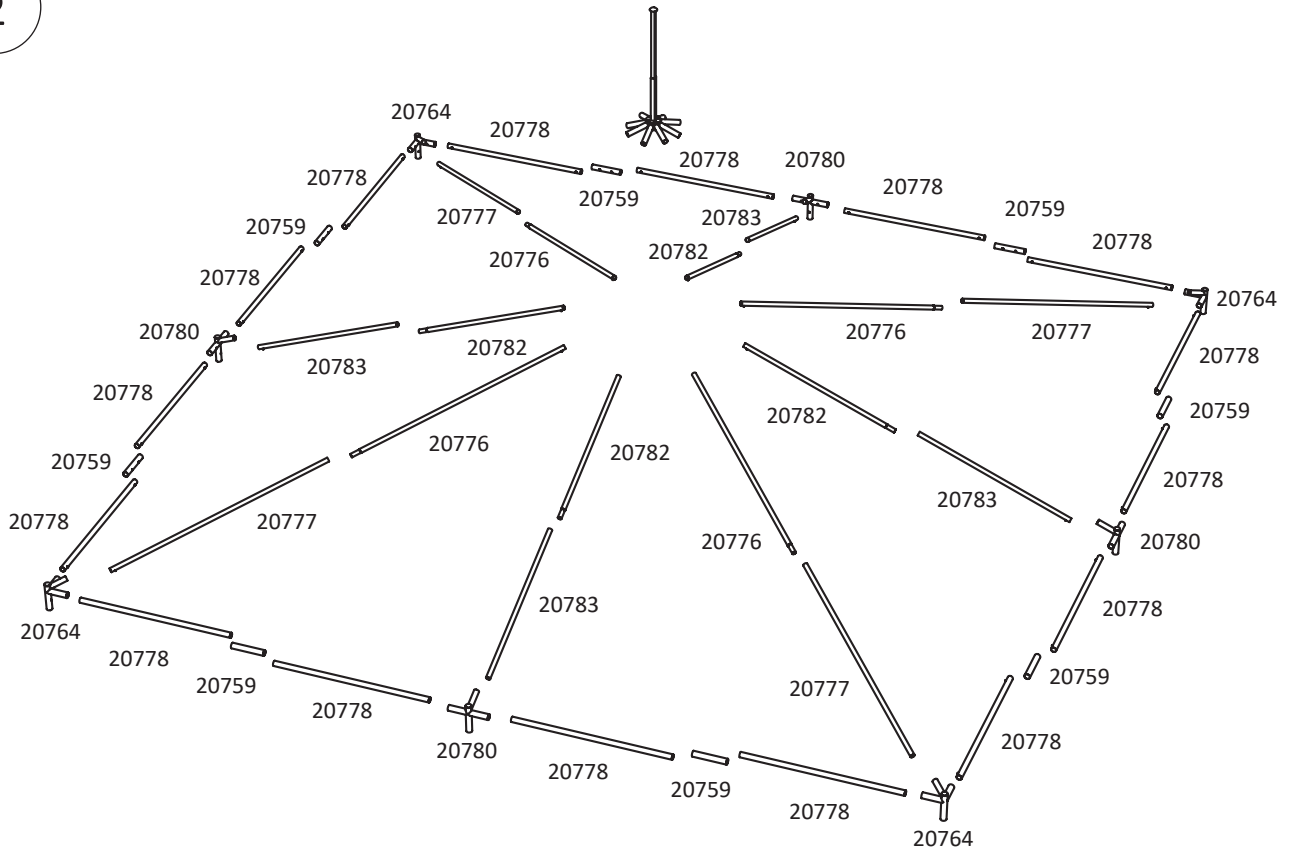

 **PAG-L2-Q4 5 m x 5 m**

2



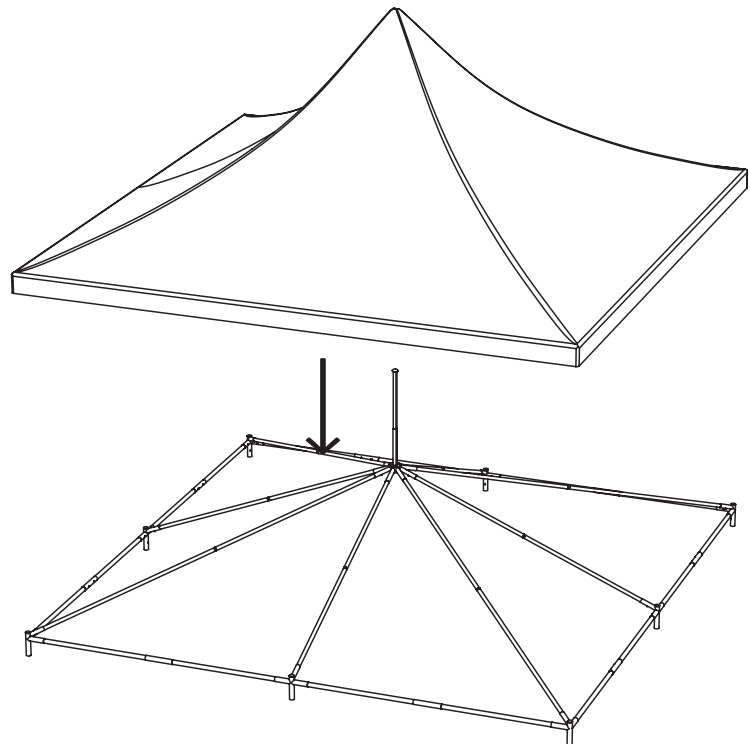

3

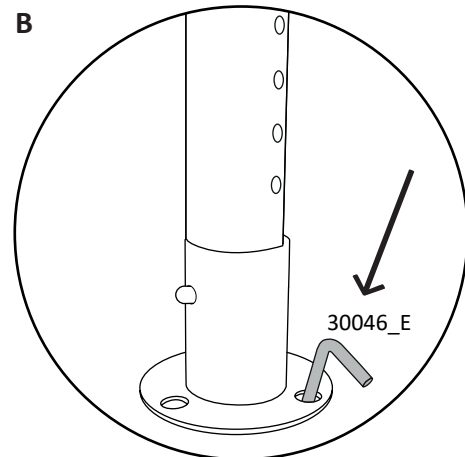
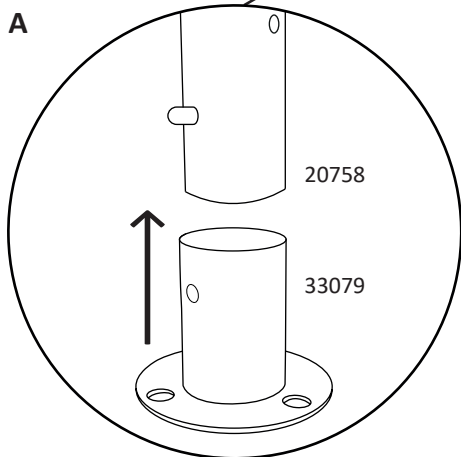
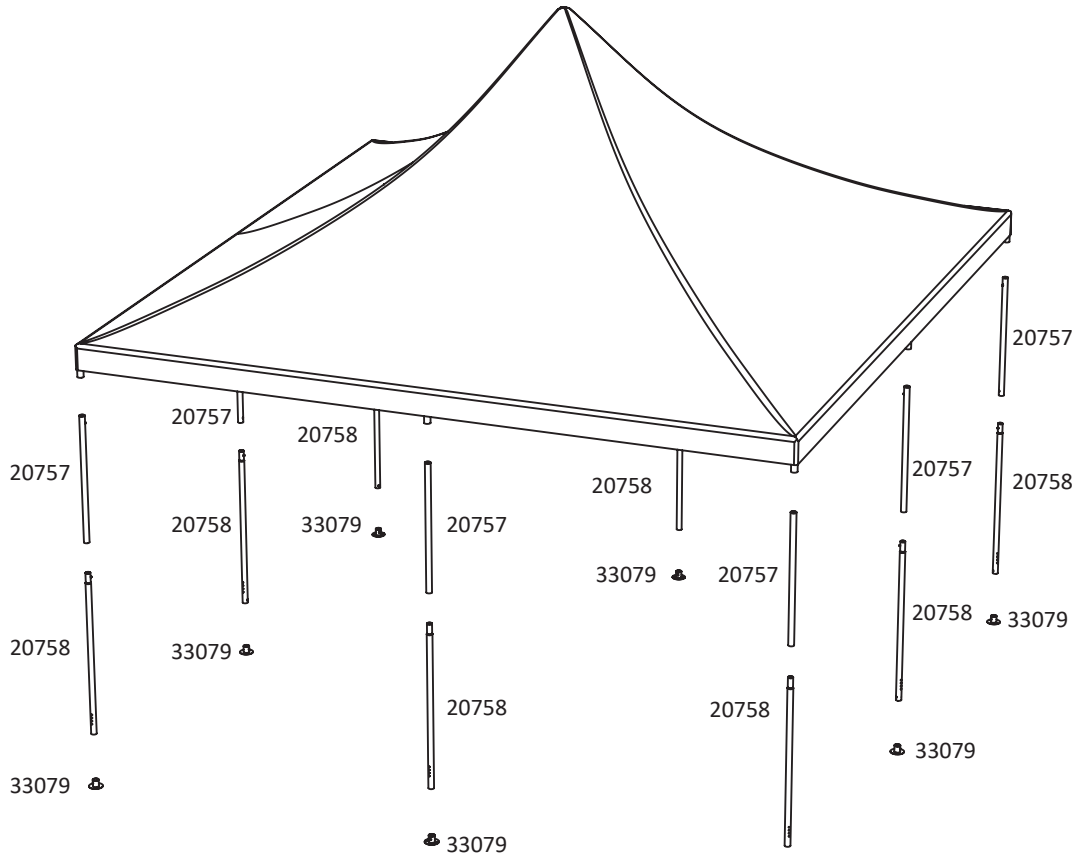

 **PAG-L2-Q4 5 m x 5 m**

4



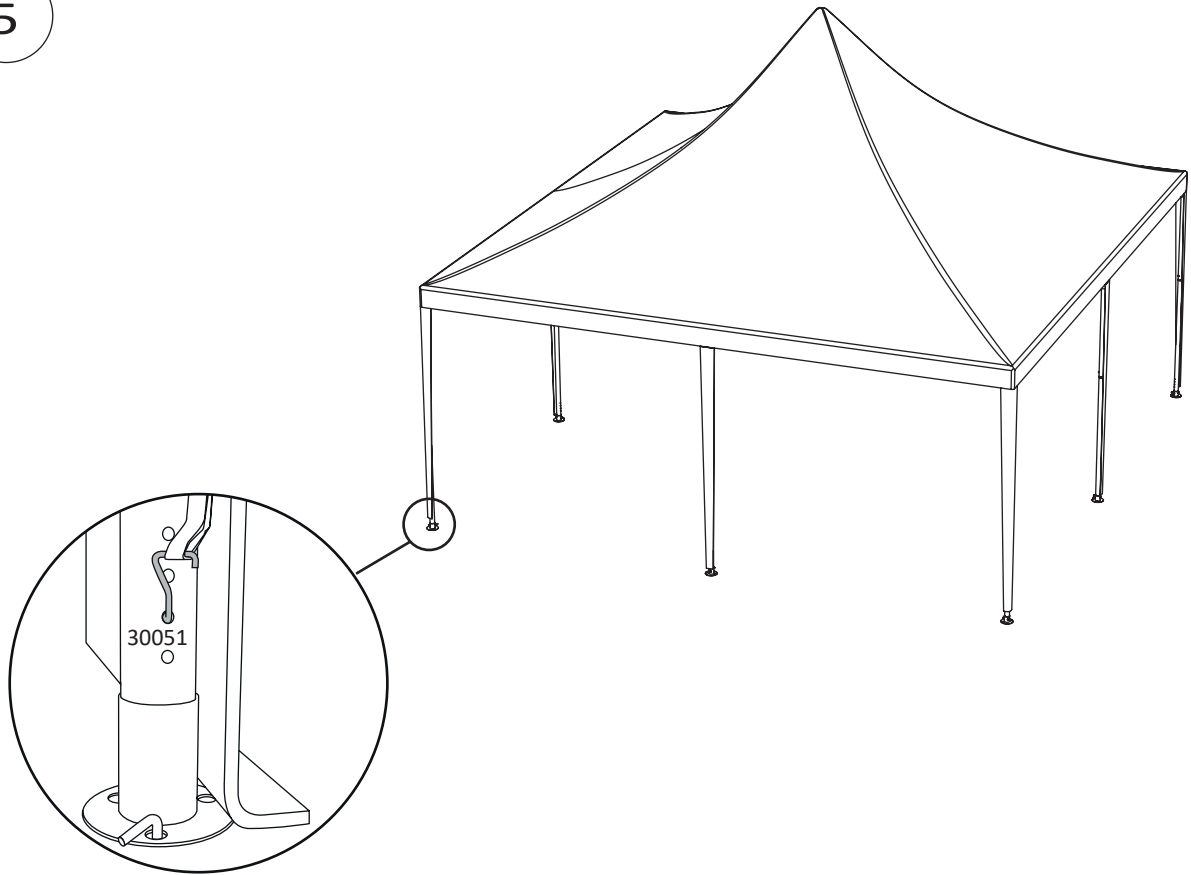

 **PAG-L2-Q4 5 m x 5 m**

5

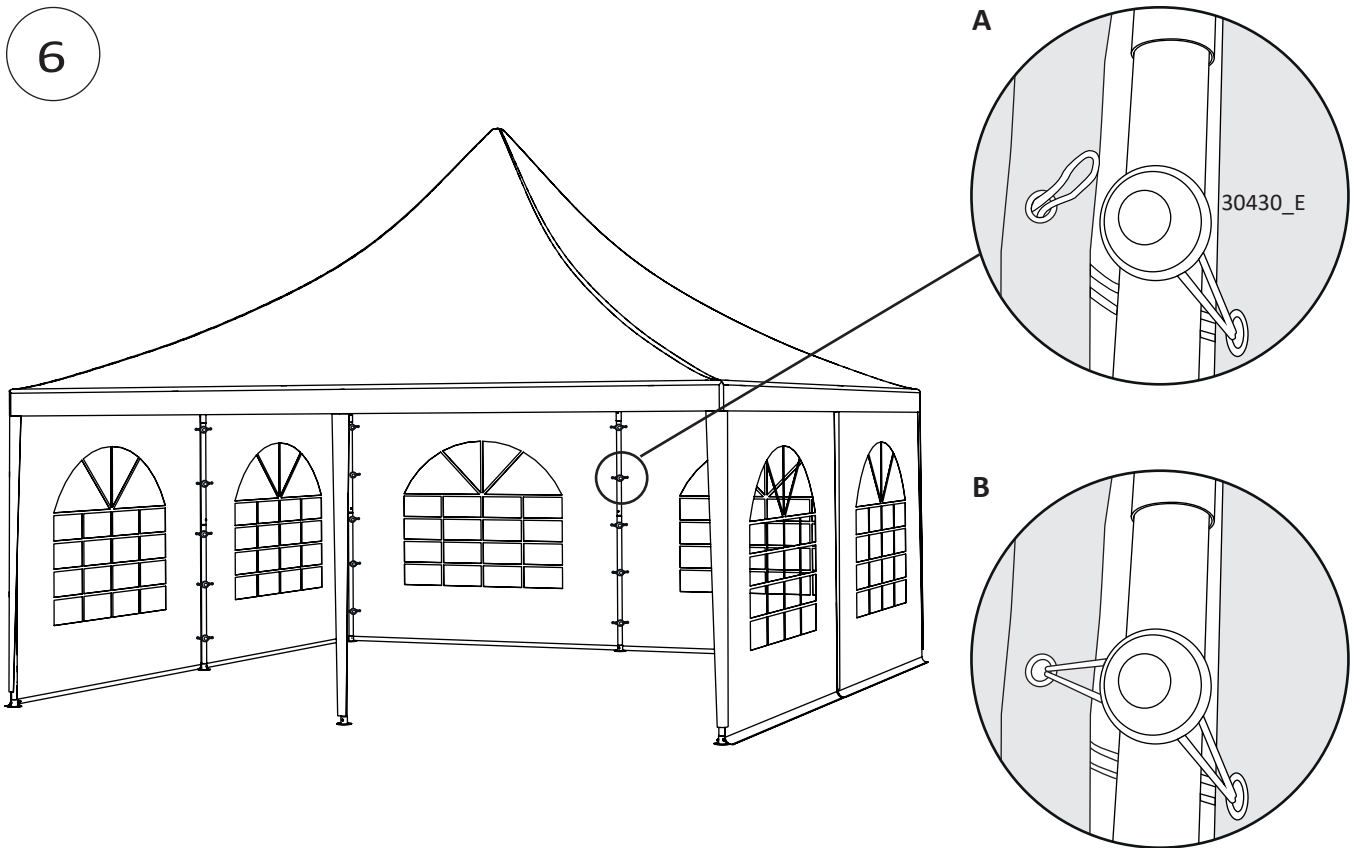

6



 **PAG-L2-Q4 5 m x 5 m**

7

