

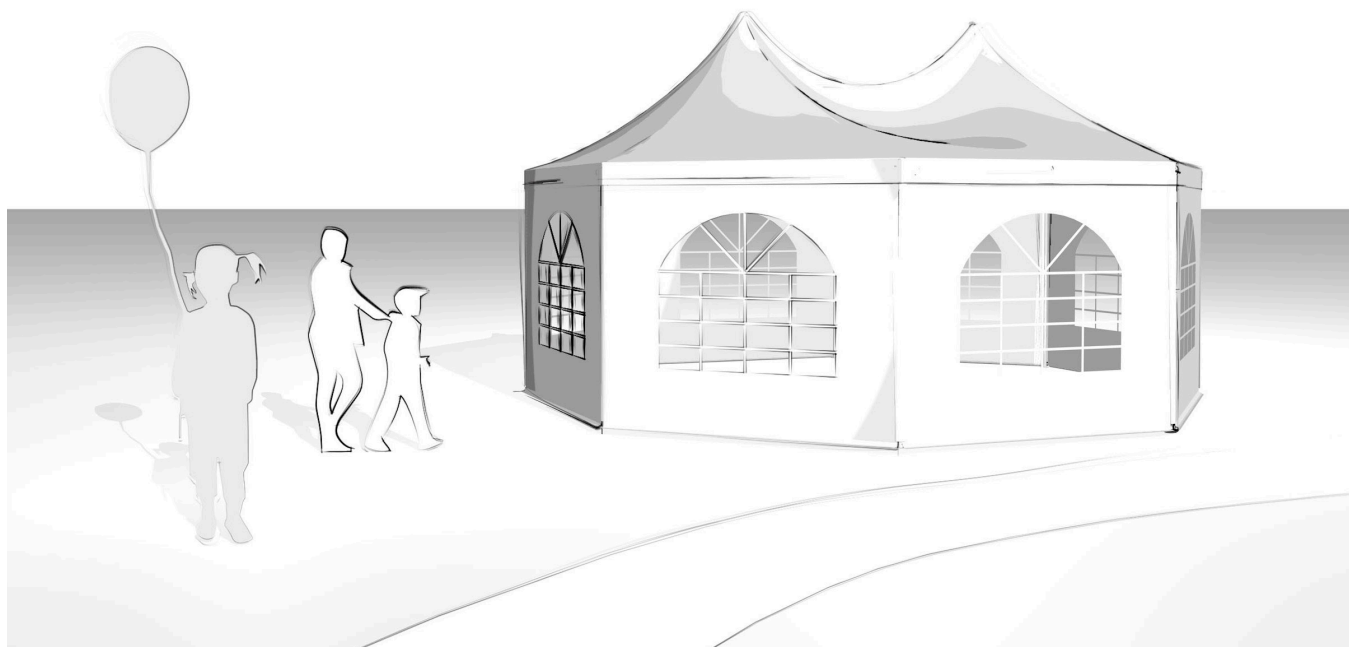

 **PAG-L2-Q4** 6 m x 6 m



01/2025-02

TOOLPORT

 **PAG-L2-Q4 6 m x 6 m**

A

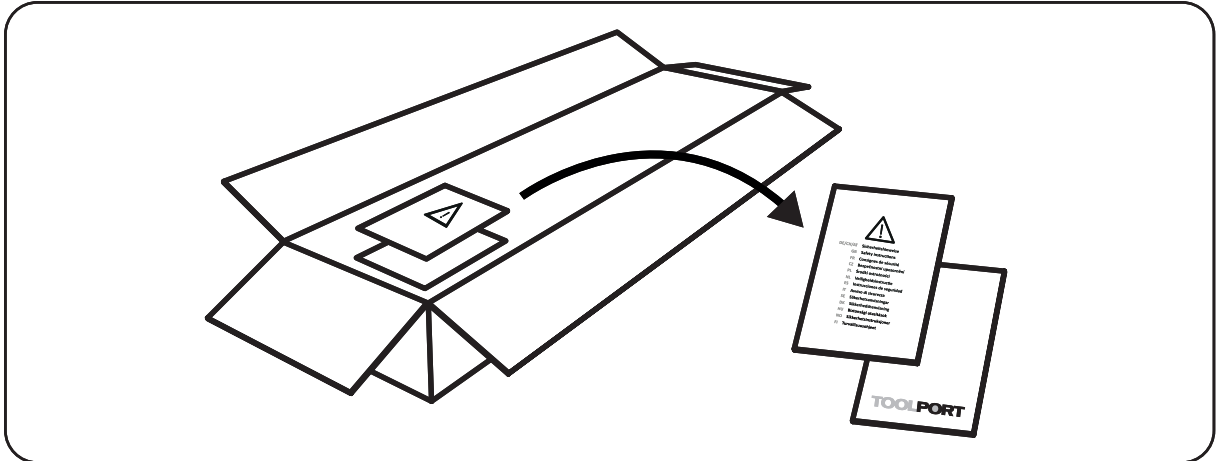

B

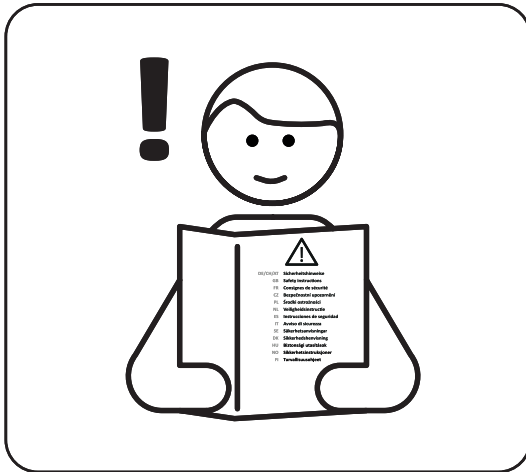



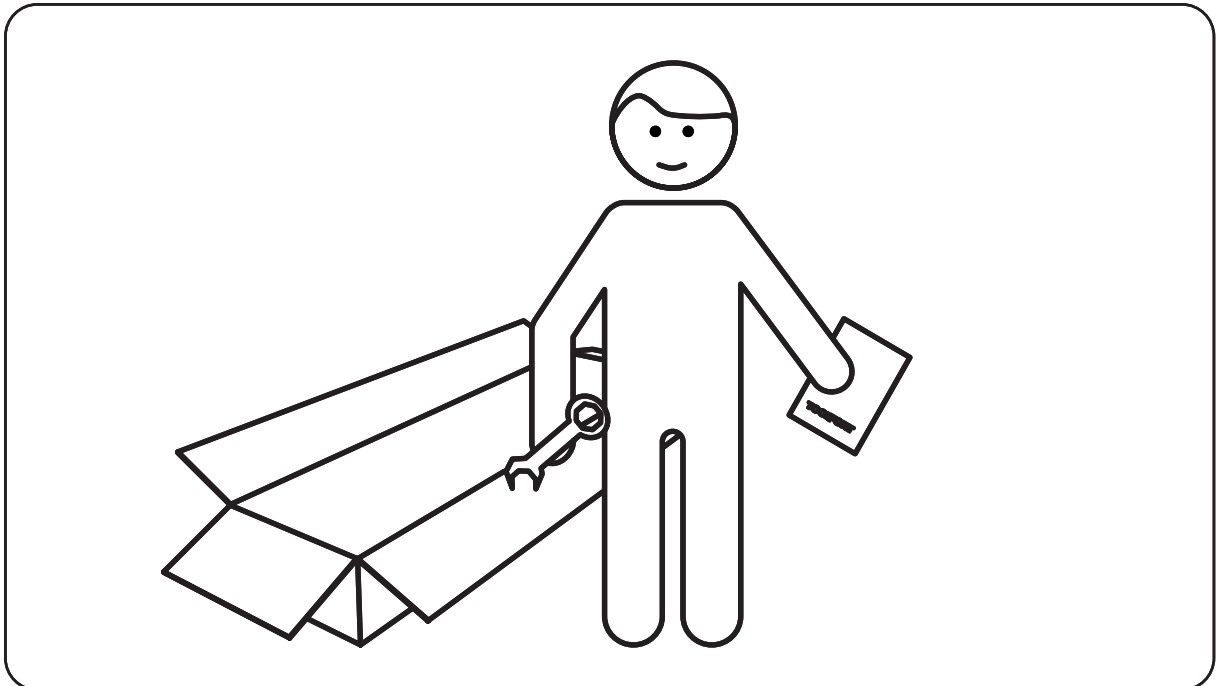



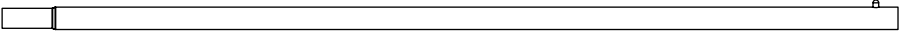
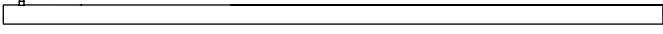
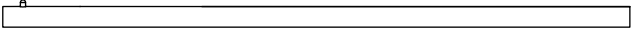
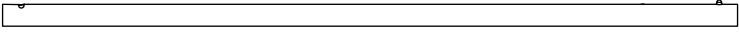
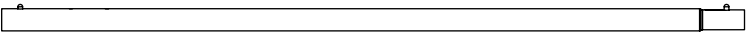
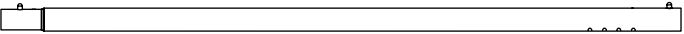
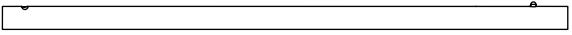
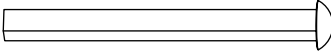
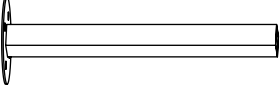
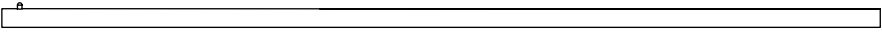
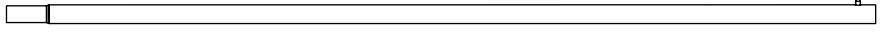
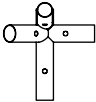
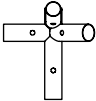
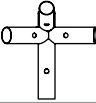
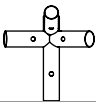
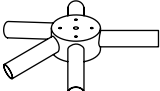

C



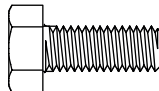
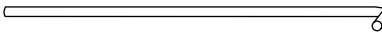
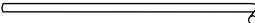
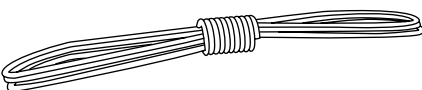

 **PAG-L2-Q4 6 m x 6 m**

Item no.		Q'ty
20806	 Ø 32 x 1258 mm	5
20814	 Ø 32 x 1116 mm	1
20815	 Ø 32 x 962 mm	4
20809	 Ø 38 x 1240 mm	8
20810	 Ø 38 x 1243 mm	8
20758	 Ø 38 x 1182 mm	8
20757	 Ø 38 x 905 mm	8
20760		2
20761		2
20816	 Ø 32 x 1525 mm	4
20817	 Ø 32 x 1525 mm	4
20820		2
20821		2
20819		2
20818		2
20823		2

 **PAG-L2-Q4 6 m x 6 m**

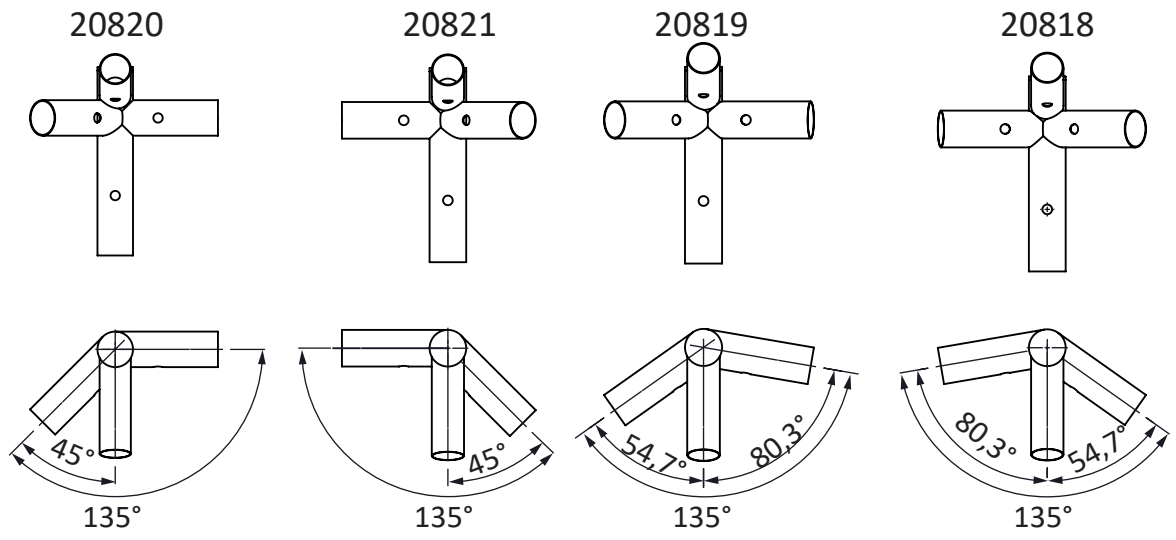
Item no.		Q'ty
33079		8
		1
		6
		2
20765	M8 x 15 mm 	8
30046_E	Ø 6 x 180 mm 	8
30047_E	Ø 4 x 160 mm 	44
30050		8
30430_E		84
30051		8
20762		2



 **PAG-L2-Q4 6 m x 6 m**

1

2x

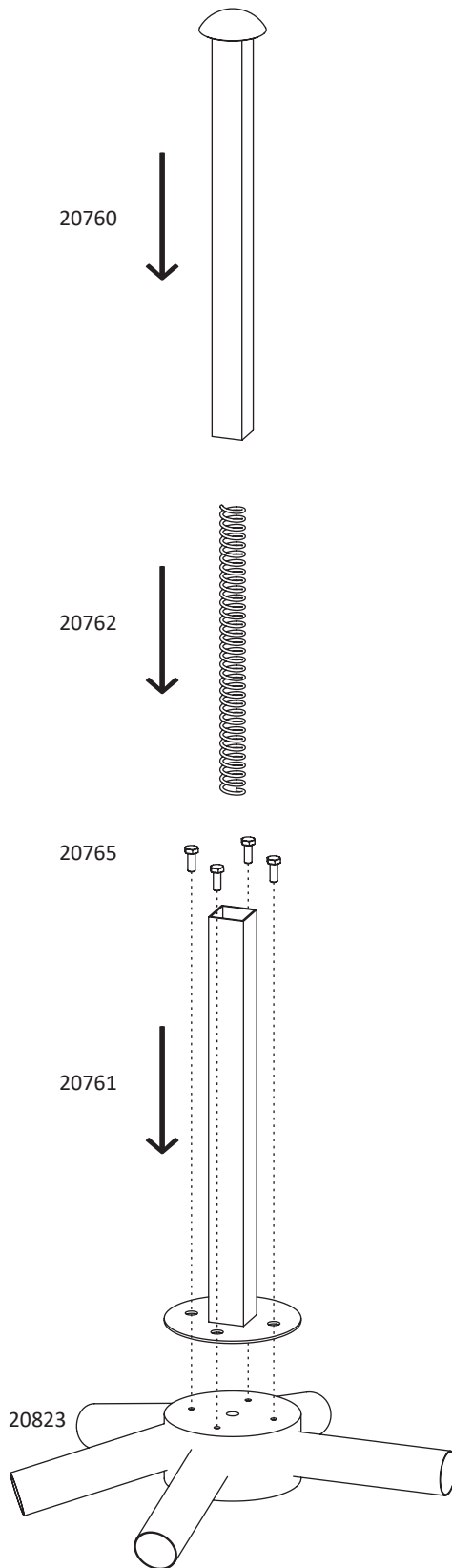

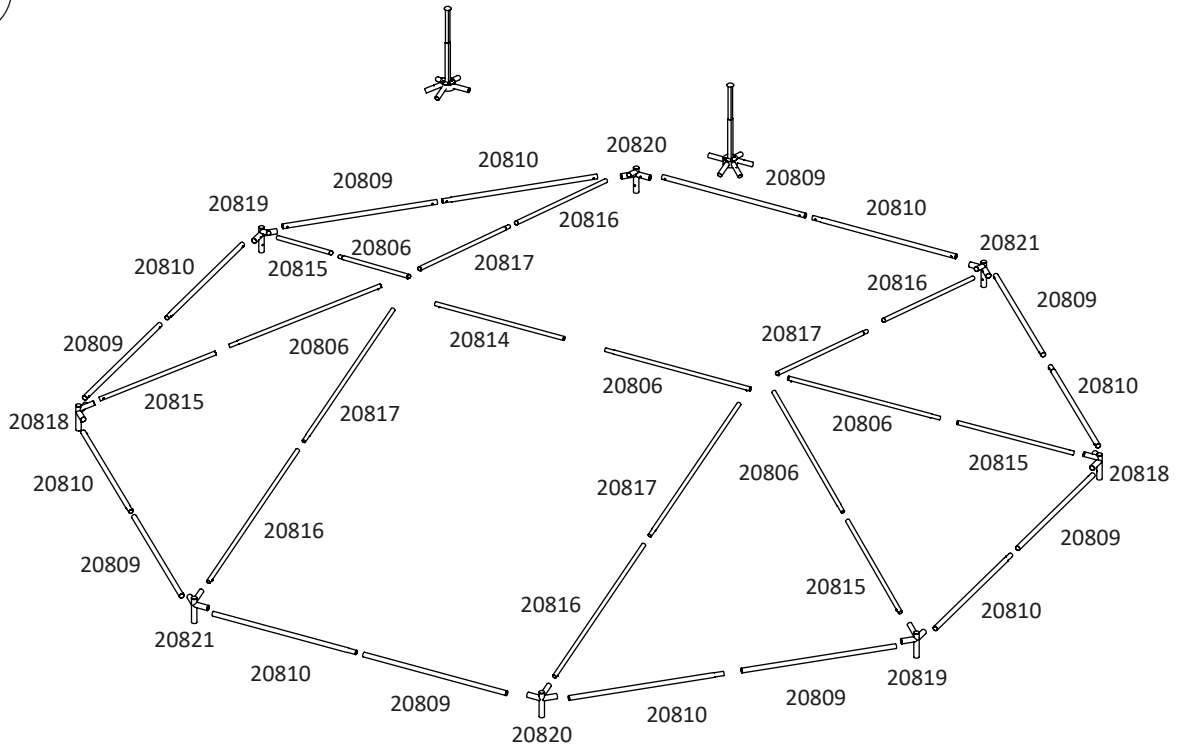

 **PAG-L2-Q4 6 m x 6 m**

2



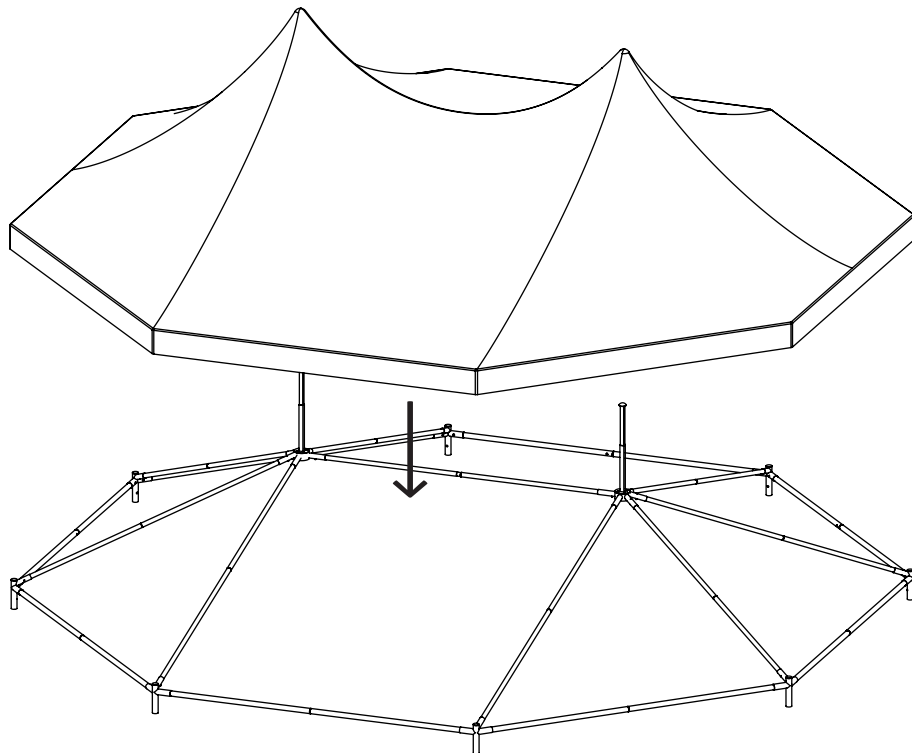

3

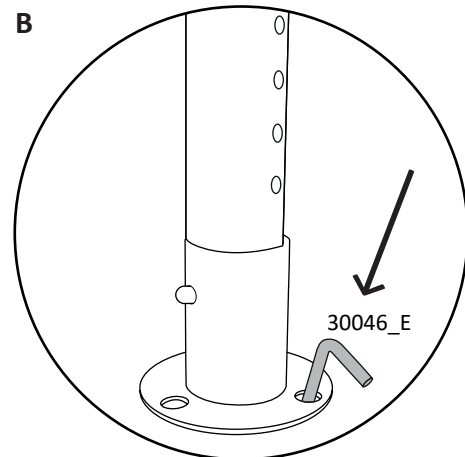
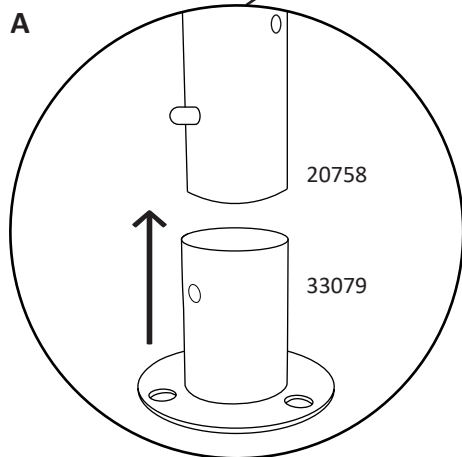
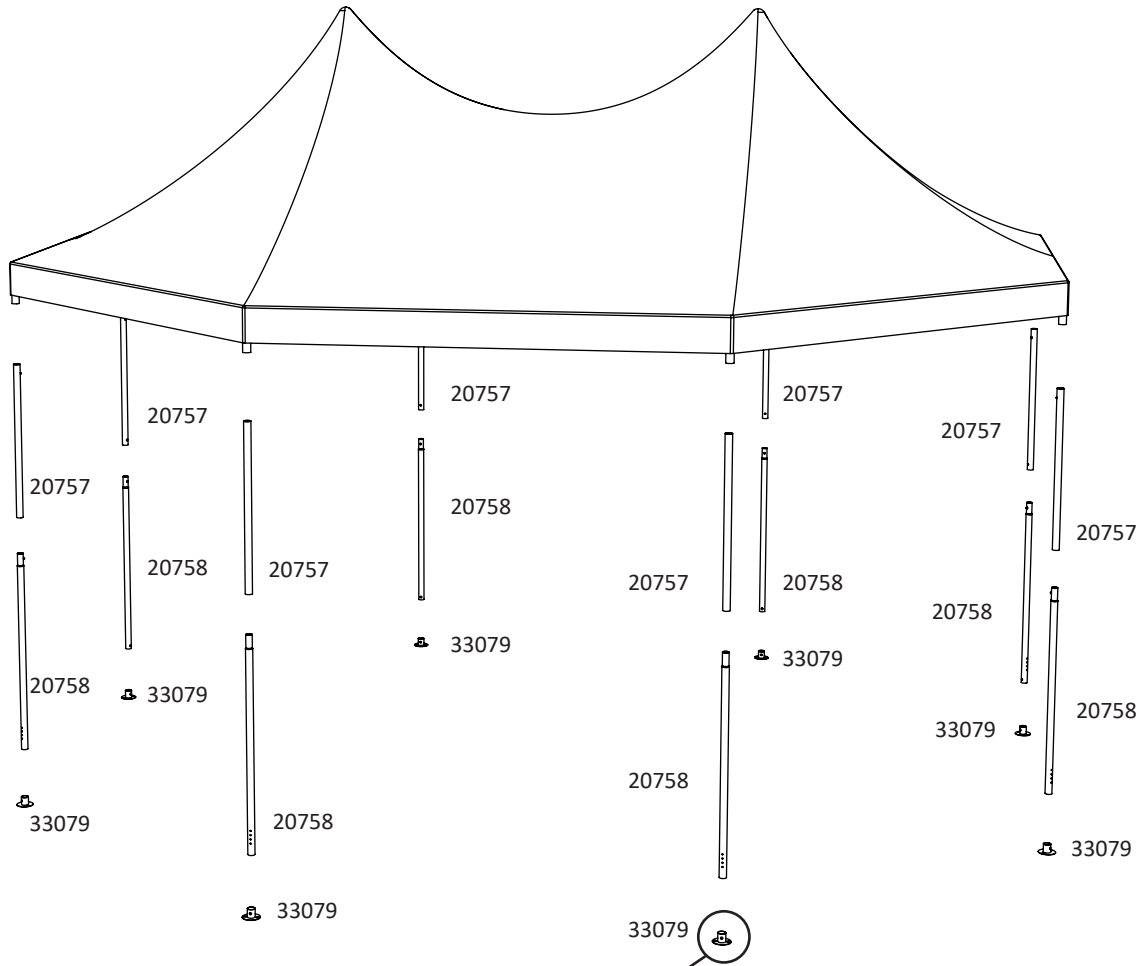

 **PAG-L2-Q4 6 m x 6 m**

4



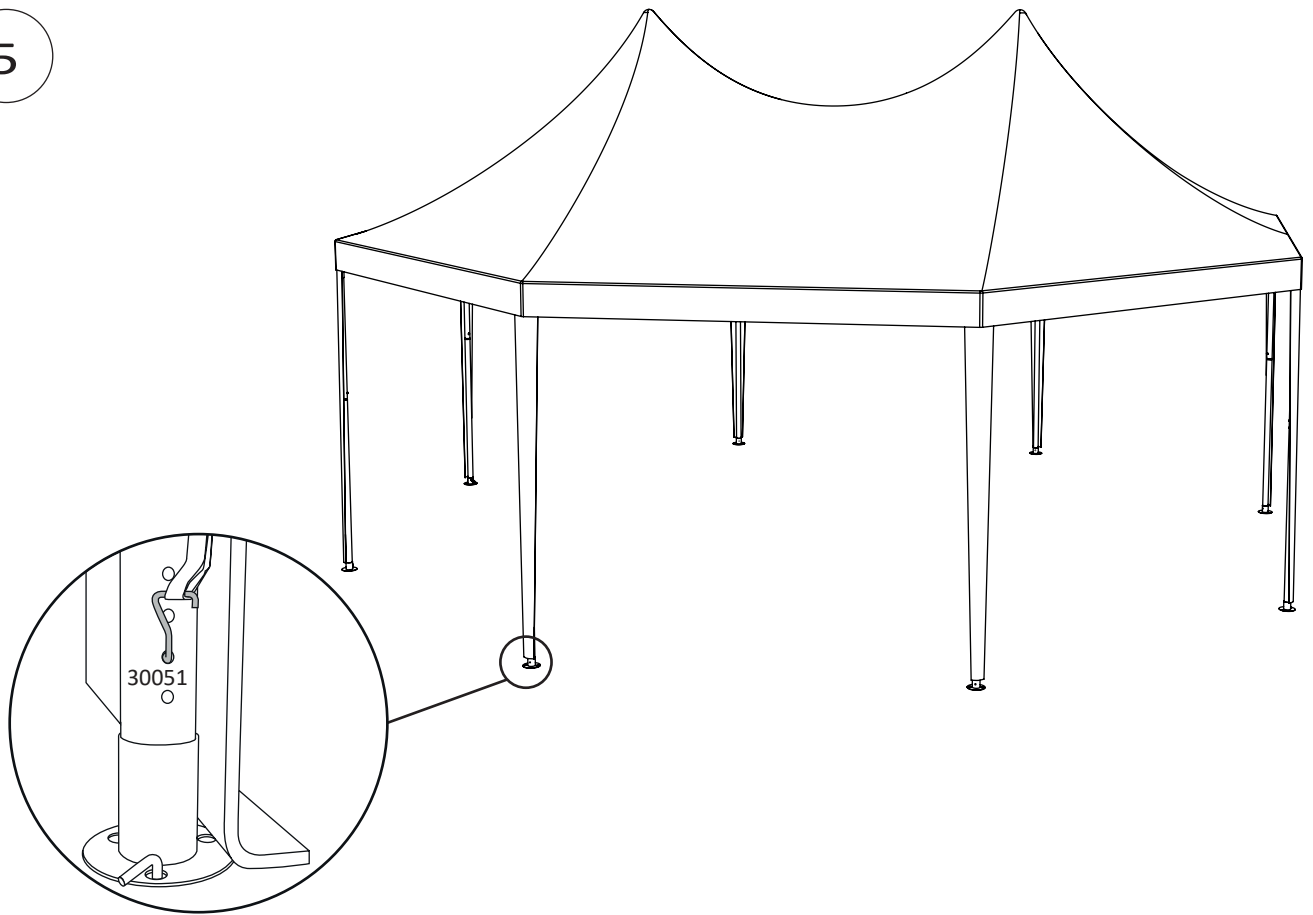

 **PAG-L2-Q4 6 m x 6 m**

5

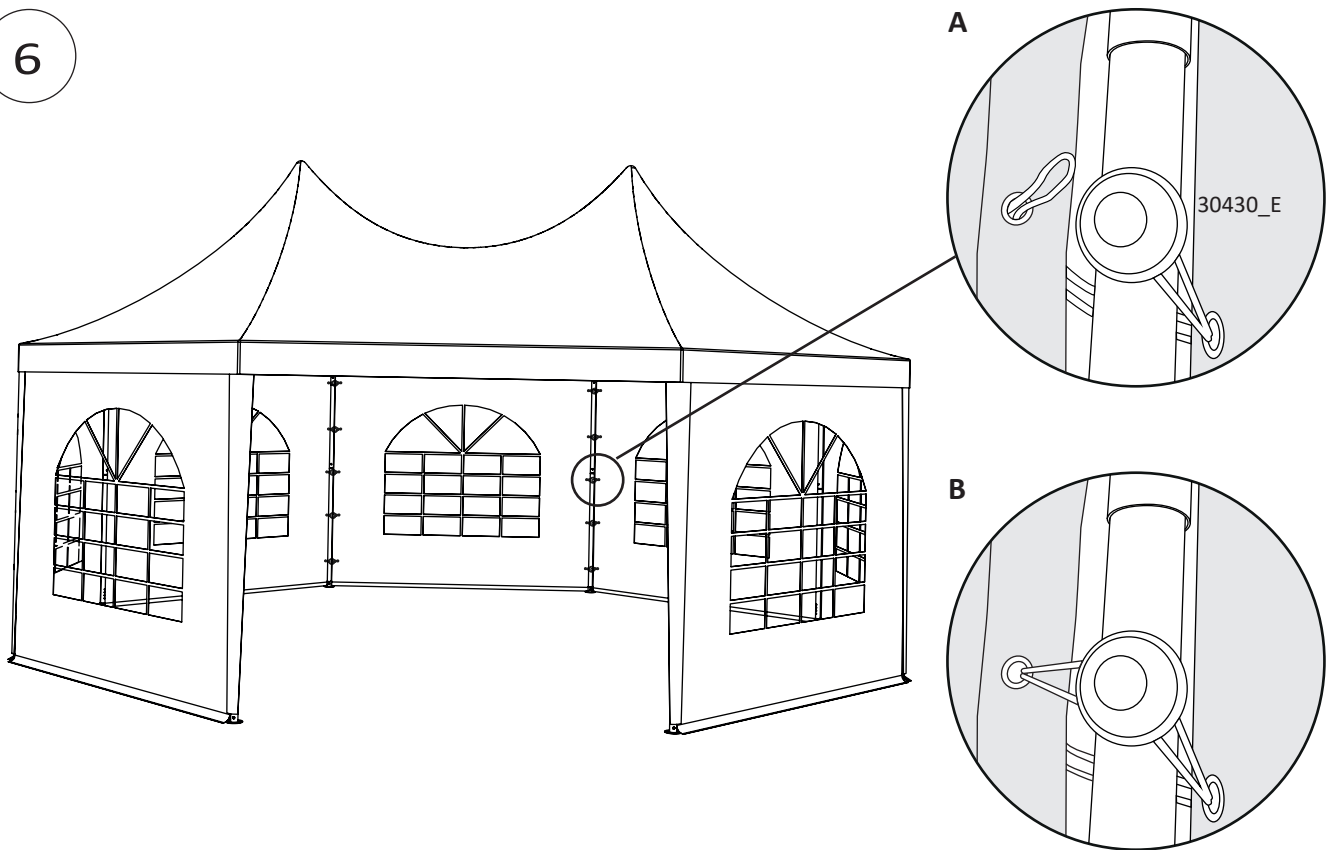

6



 **PAG-L2-Q4 6 m x 6 m**

7

