

EVEREST 12 m x 12 m, 12 m x 20 m
1 m arch distance

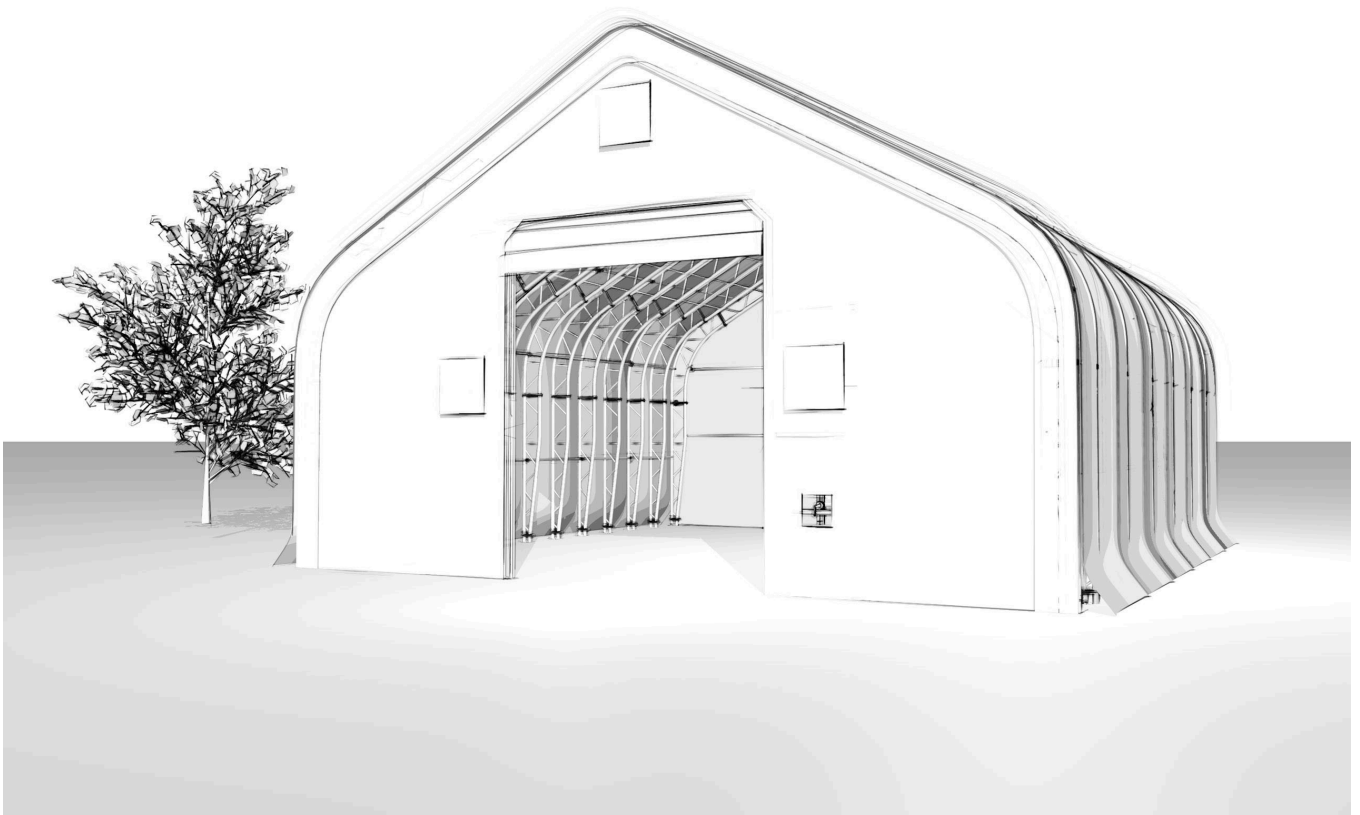

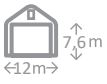

EVEREST 12 m x 12 m, 12 m x 20 m

1 m arch distance

A

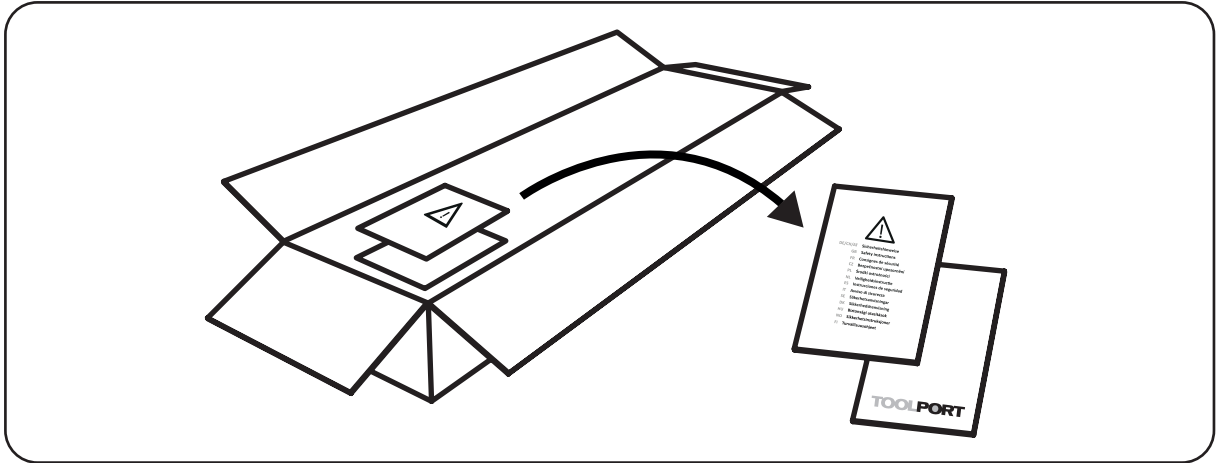

B

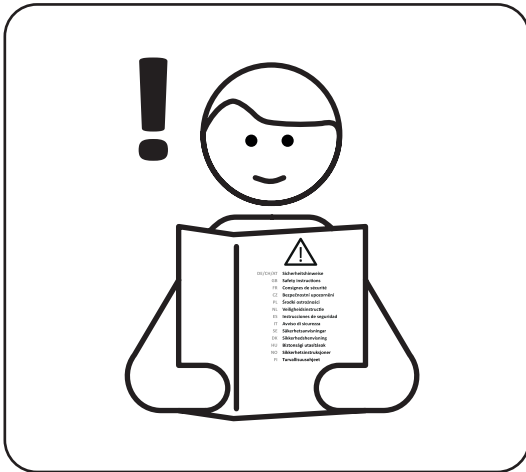



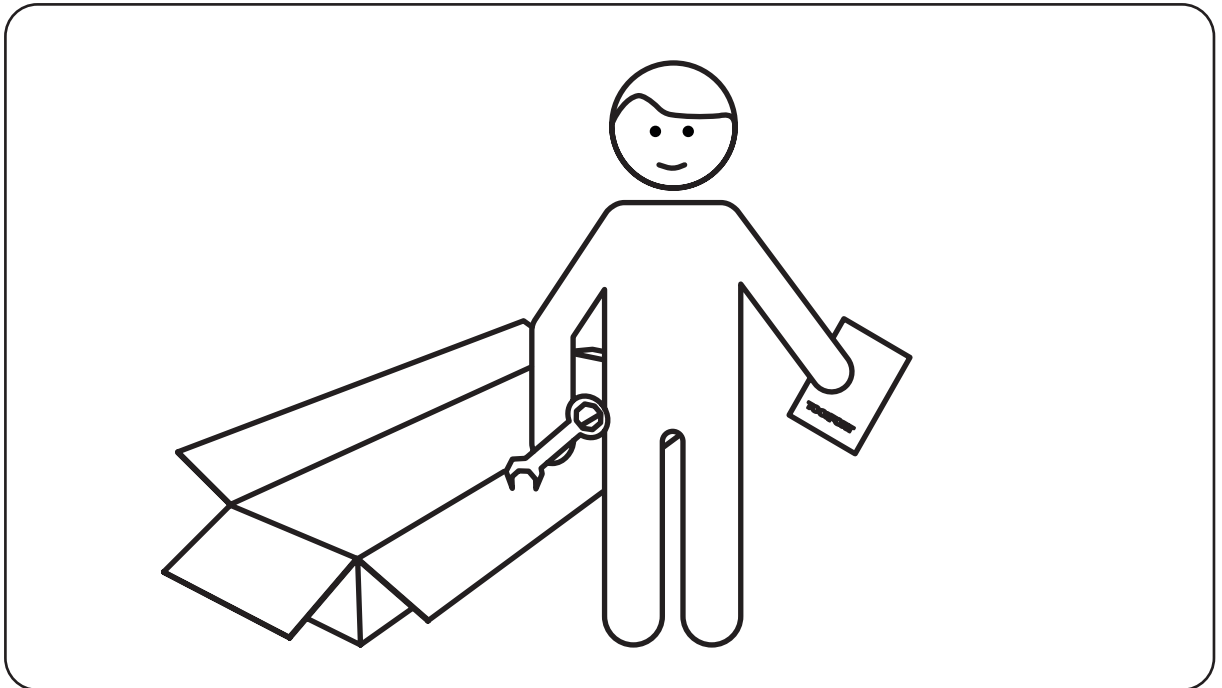

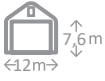





C

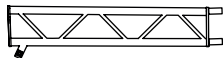

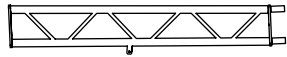
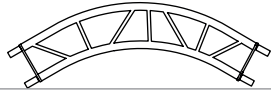

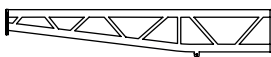
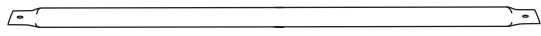
EVEREST 12 m x 12 m, 12 m x 20 m

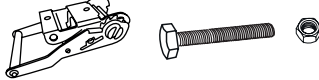
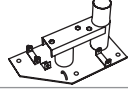
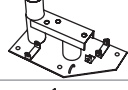
1 m arch distance

| Item no. | ID | | 12 m | 20 m |
|----------|----|--------------------------------------------------------------------------------------|------|------|
| 2000 | 1 |  | 11 | 19 |
| 2051 | 1A |  | 2 | 2 |
| 2001 | 2 |  | 22 | 38 |
| 2063 | 2A |  | 4 | 4 |
| 2002 | 3 |  | 22 | 38 |
| 2064 | 3A |  | 4 | 4 |
| 2003 | 4 |  | 22 | 38 |
| 2065 | 4A |  | 4 | 4 |
| 2004 | 5 |  | 22 | 38 |
| 2066 | 5A |  | 4 | 4 |
| 2005 | 6 |  | 132 | 220 |
| 2007 | 7 |  | 22 | 38 |
| 2067 | 7A |  | 30 | 46 |
| 2068 | 7L |  | 2 | 2 |
| 2069 | 7R |  | 2 | 2 |
| 2008 | 8 |  | 4 | 4 |
| 2009 | 9 |  | 4 | 4 |

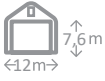

EVEREST 12 m x 12 m, 12 m x 20 m





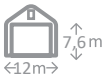







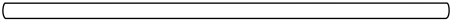

1 m arch distance

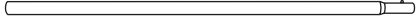
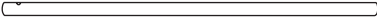
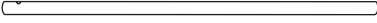
| Item no. | ID | | 12 m | 20 m |
|----------|-----|----------------------|------|------|
| 2037 | 10L | | 2 | 2 |
| 2038 | 10R | | 2 | 2 |
| 2039 | 11L | | 2 | 2 |
| 2040 | 11R | | 2 | 2 |
| 2041 | 12A | | 2 | 2 |
| 2042 | 12L | | 2 | 2 |
| 2043 | 12R | | 2 | 2 |
| 2010 | 13 | | 2 | 2 |
| 2044 | 13A | | 2 | 2 |
| 2045 | 14L | | 2 | 2 |
| 2046 | 14R | | 2 | 2 |
| 2011 | 15 | | 8 | 8 |
| 2047 | 15A | | 4 | 4 |
| 2048 | 15B | | 4 | 4 |
| 2012 | 16 | | 2 | 2 |
| 2013 | 17 | reinforcement (side) | 24 | 40 |
| 2014 | 18 | | 54 | 70 |
| 2049 | 18A | | 12 | 20 |



EVEREST 12 m x 12 m, 12 m x 20 m

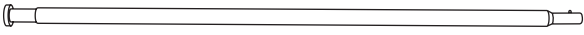
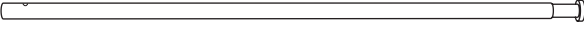



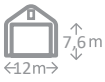







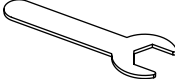

1 m arch distance

| Item no. | ID | | 12 m | 20 m |
|----------|-----|--------------------------------------------------------------------------------------------------------|------|------|
| 2015 | 19 | reinforcement (roof)  | 16 | 16 |
| 2050 | 19A | reinforcement (roof)  | 11 | 19 |
| 2016 | 20 |  | 4 | 4 |
| 2052 | 20A |  | 4 | 4 |
| 2017 | 21 |  | 136 | 200 |
| 2053 | 21A |  | 136 | 200 |
| 2054 | 22A |  | 8 | 12 |
| 2055 | 22B |  | 2 | – |
| 2056 | 22B |  | – | 2 |
| 2018 | 23 | M14 X 50 mm  | 506 | 798 |
| 2057 | 23A | M12 X 40 mm  | 16 | 16 |
| 2019 | 24 | M12 X 110 mm  | 143 | 231 |
| 2058 | 24A | M10 X 90 mm  | 24 | 24 |
| 2059 | 24B | M10 X 70 mm  | 8 | 8 |
| 2060 | 25A |  | 14 | 14 |
| 2061 | 25B |  | 14 | 14 |
| | 26 |  | 2 | 2 |
| 2062 | 26A |  | 2 | 2 |



EVEREST 12 m x 12 m, 12 m x 20 m

1 m arch distance

| Item no. | ID | | 12 m | 20 m |
|----------|----|------------------------------------------------------------------------------------------------------------------------|------|------|
| 2021 | 27 |  | 20 | 20 |
| 2022 | 28 |  | 1 | 1 |
| 2023 | 29 |  | 2 | 2 |
| 2024 | 30 |  | 26 | 42 |
| 2025 | 31 |  | 2 | 2 |
| 2026 | 32 | M10 X 30mm  | 28 | 28 |
| 2027 | 33 |  | 14 | 14 |
| | 34 |  | 1 | 1 |
| 2030 | 35 |  | 2 | 2 |
| 2031 | 36 |  | 2 | 2 |
| 2032 | 37 |  | W | 2 |
| 2033 | 38 | lock steel wire (door)  | 4 | 4 |
| 2034 | 39 | lock steel wire (wrench handle)  | 2 | 2 |
| 2035 | 40 |  | 4 | 4 |
| 2036 | 41 | M10 X 90mm  | 12 | 12 |

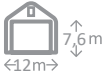

EVEREST 12 m x 12 m, 12 m x 20 m

1 m arch distance

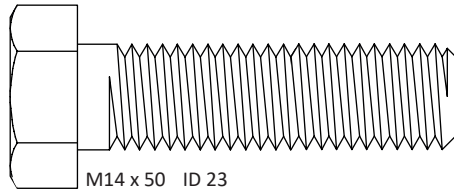

M14 x 50 ID 23

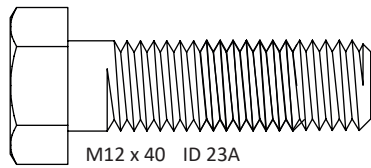

M12 x 40 ID 23A

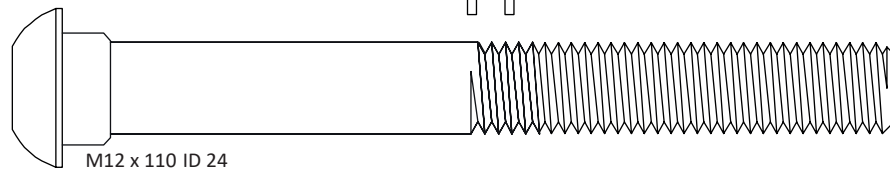

M12 x 110 ID 24

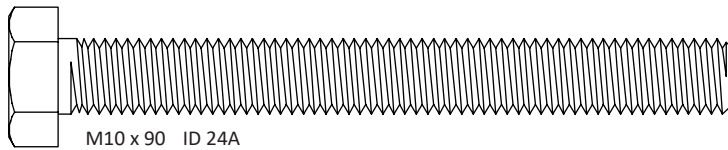

M10 x 90 ID 24A

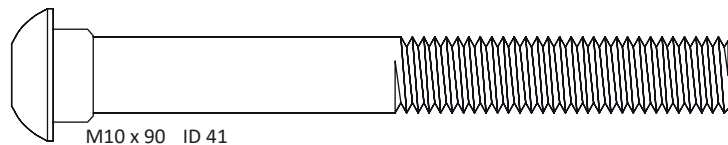

M10 x 90 ID 41

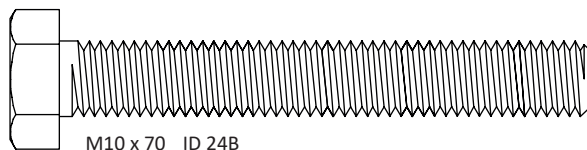

M10 x 70 ID 24B

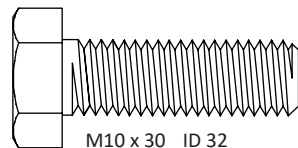

M10 x 30 ID 32

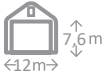

EVEREST 12 m x 12 m, 12 m x 20 m

1 m arch distance

1

Base Installation

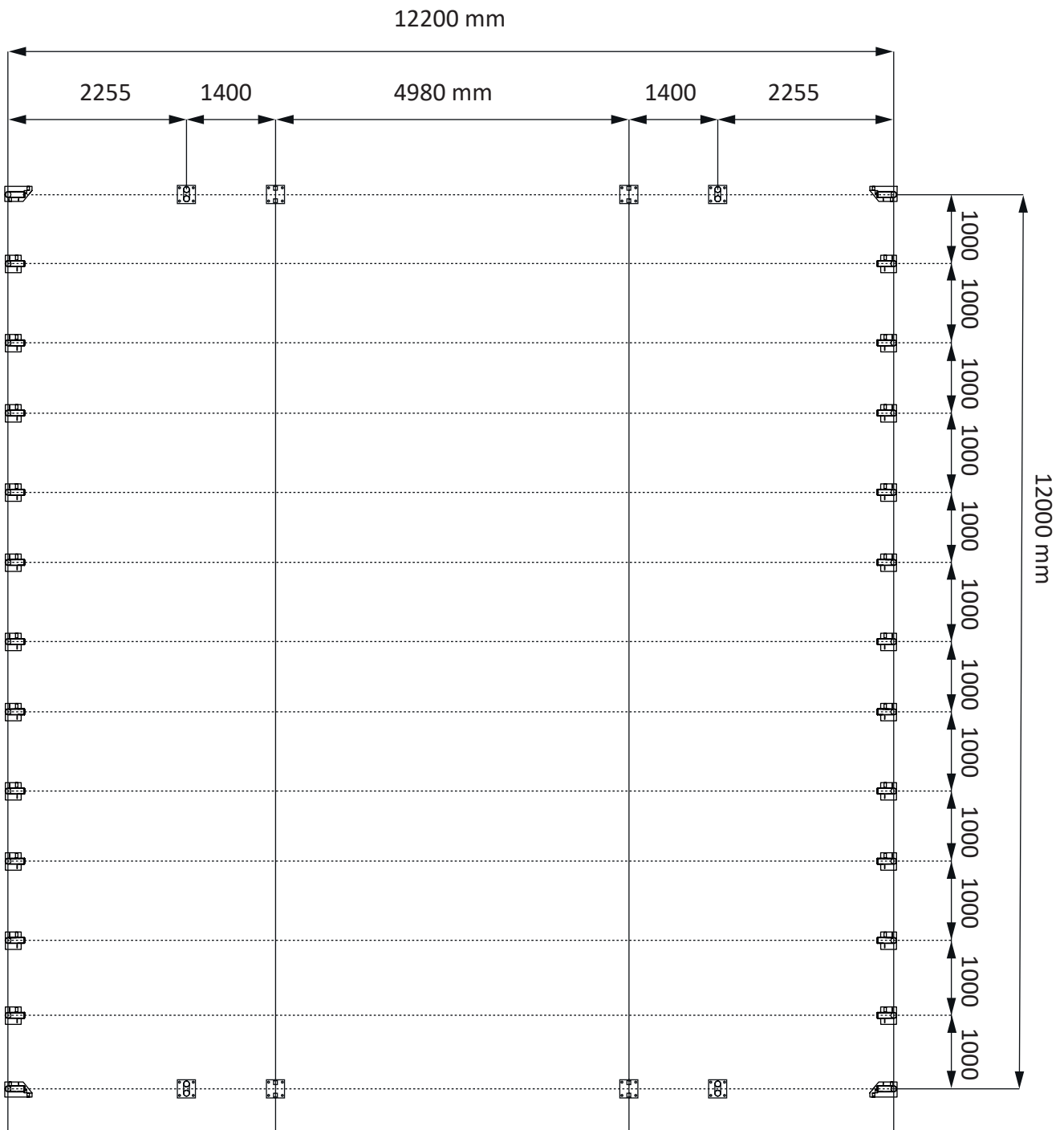

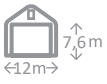

EVEREST 12 m x 12 m, 12 m x 20 m

1 m arch distance

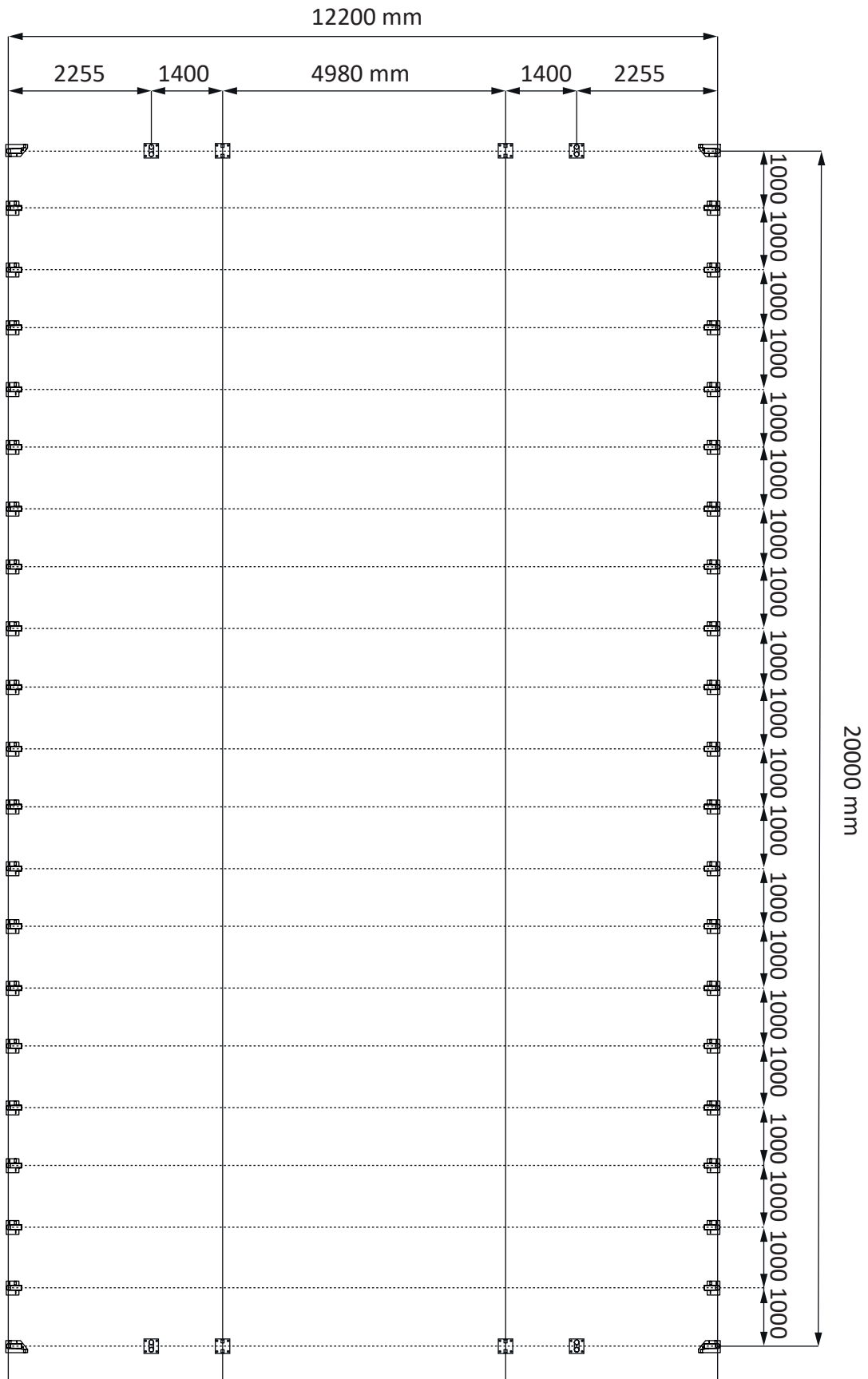

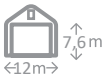

EVEREST 12 m x 12 m, 12 m x 20 m

1 m arch distance

2

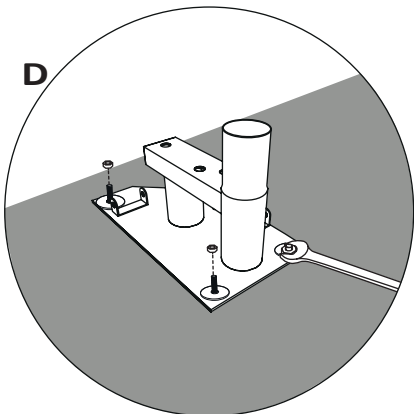
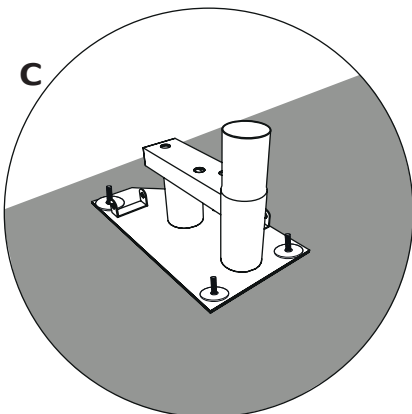
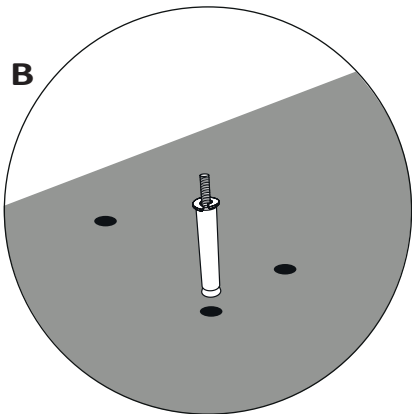
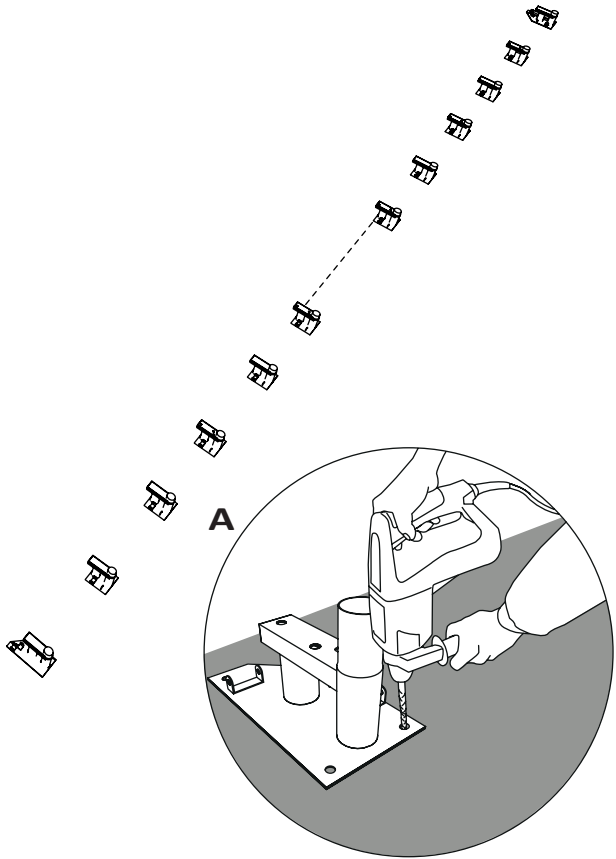
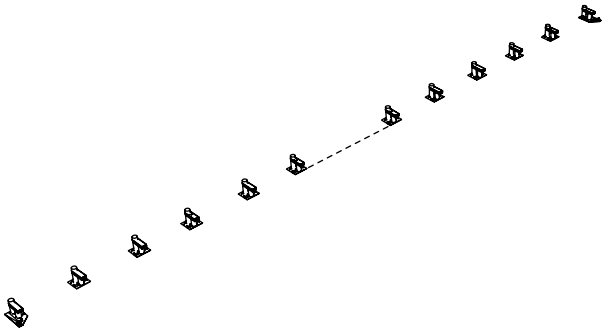
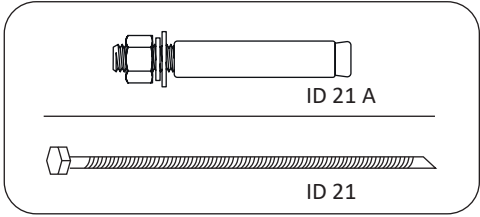
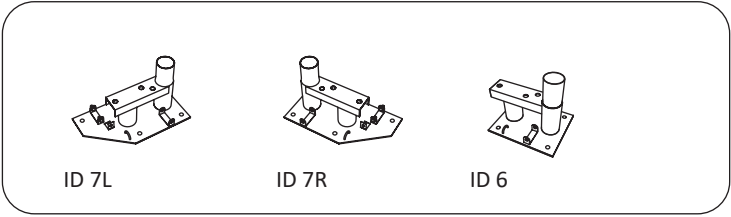

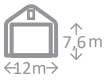

EVEREST 12 m x 12 m, 12 m x 20 m

1 m arch distance

3

2x A

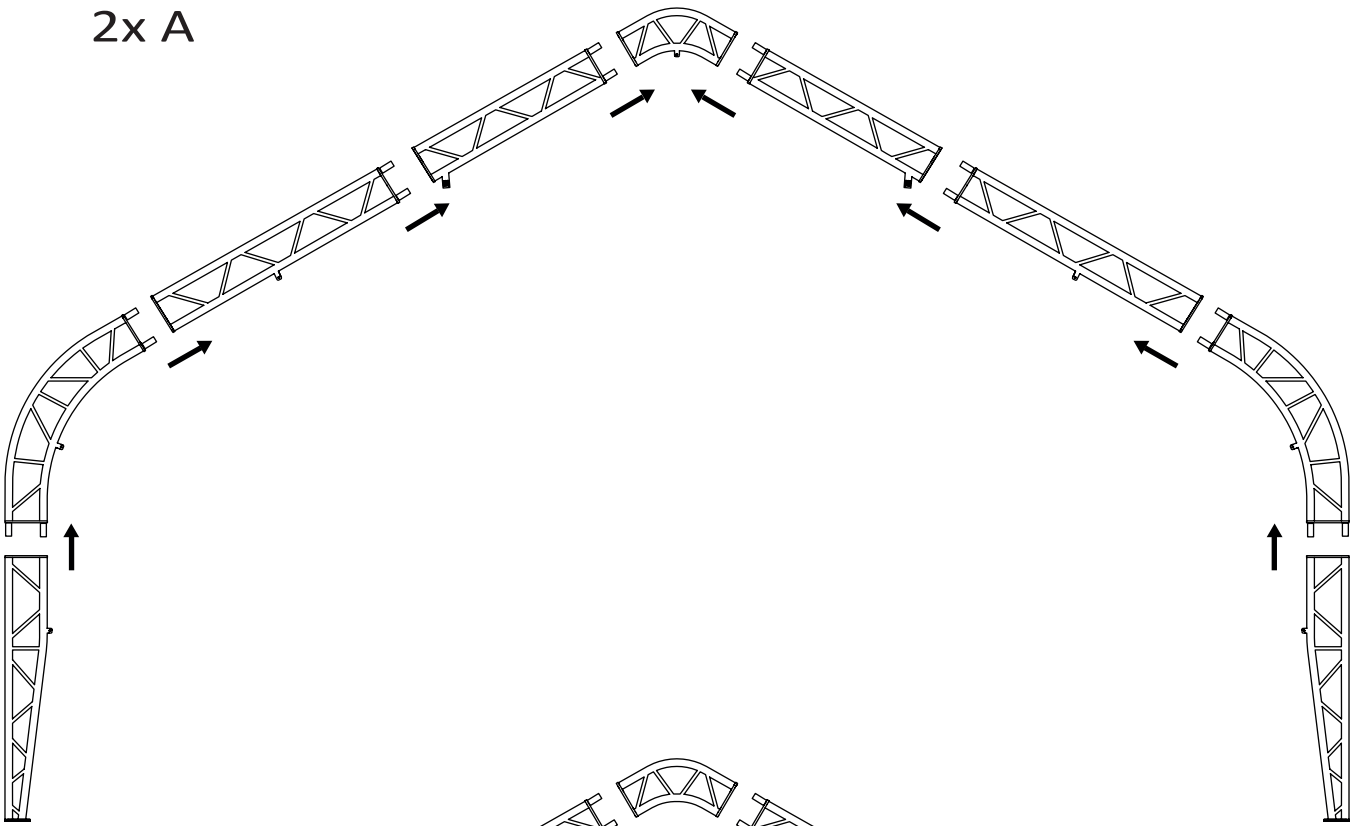

B

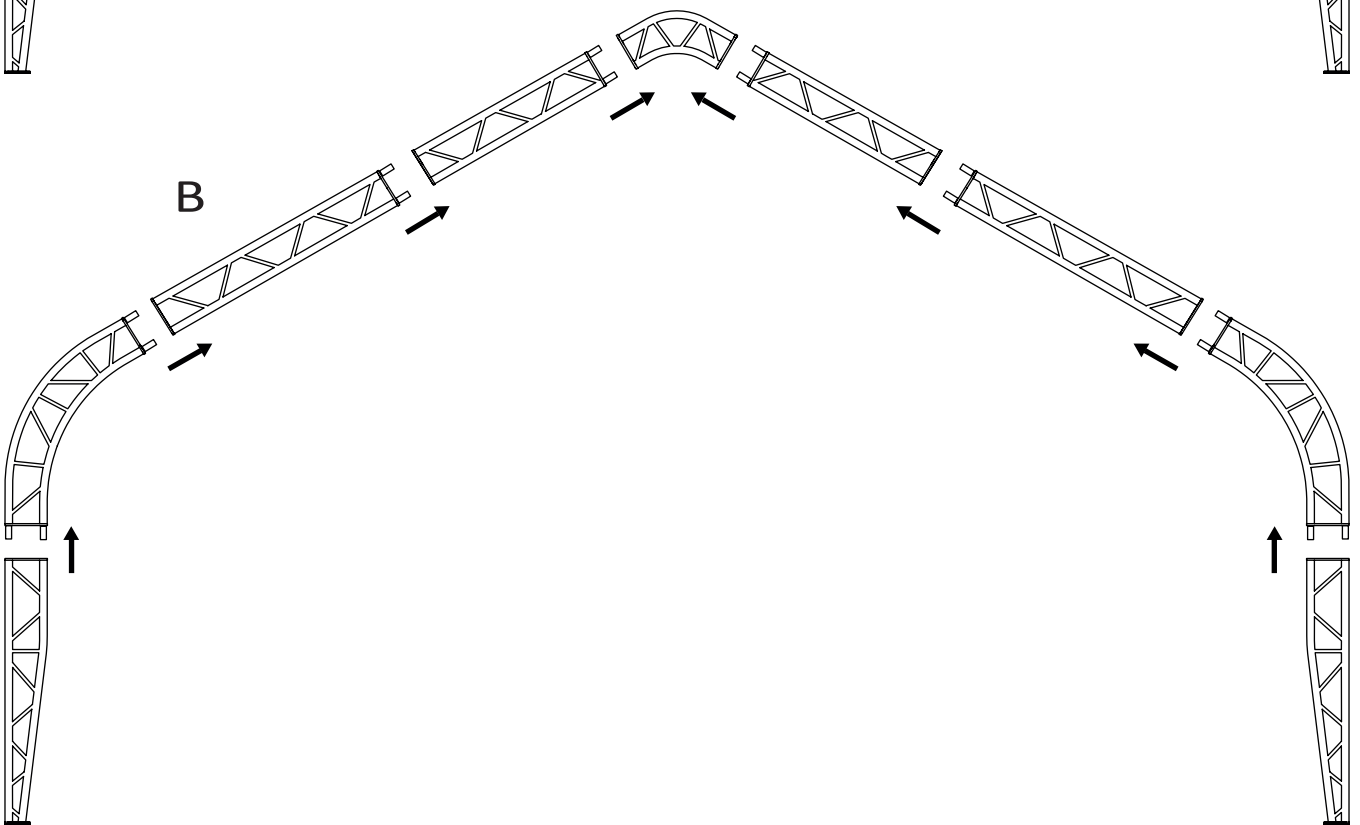

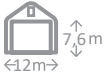

EVEREST 12 m x 12 m, 12 m x 20 m

1 m arch distance

4

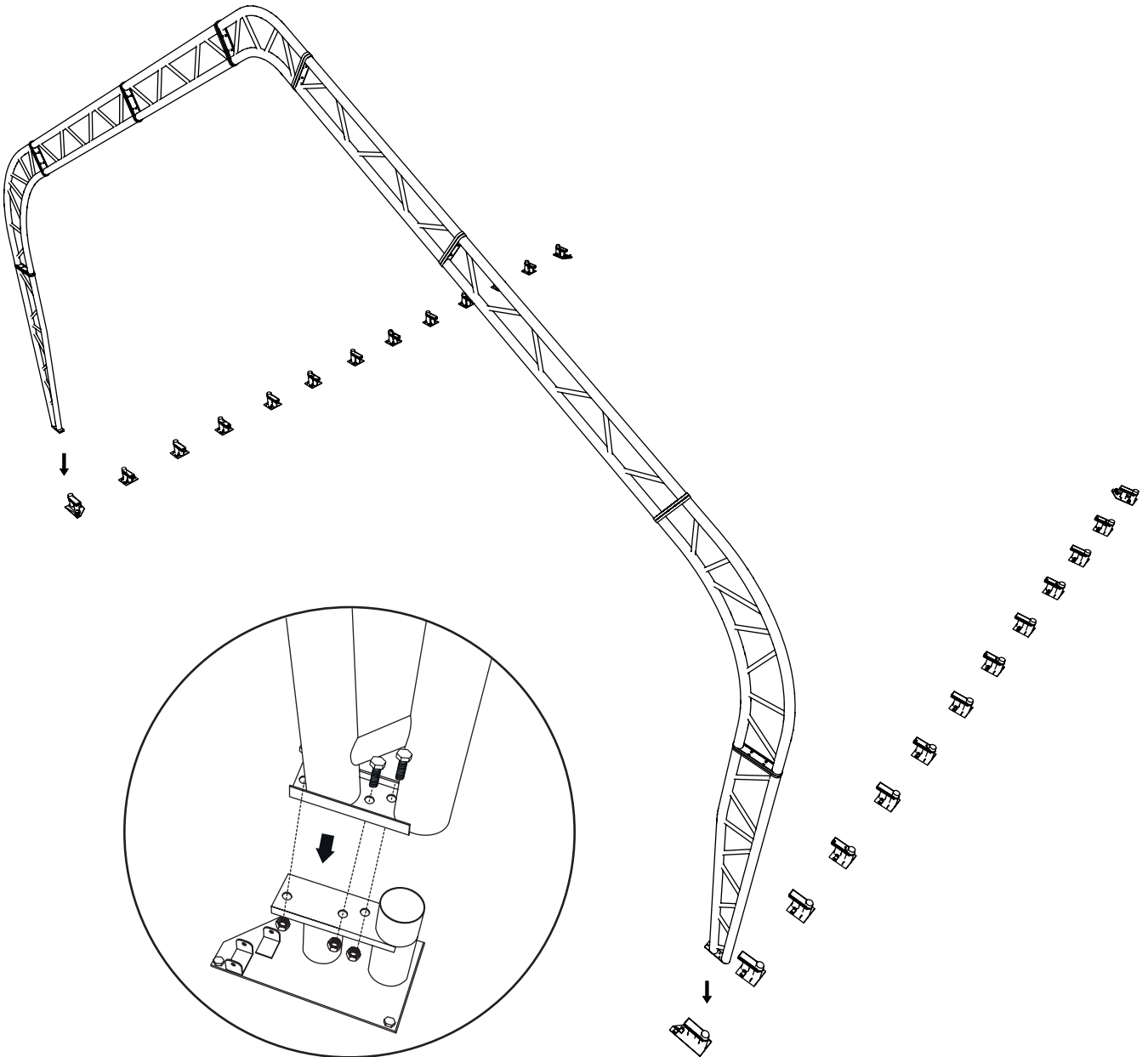
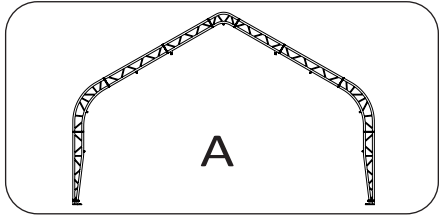
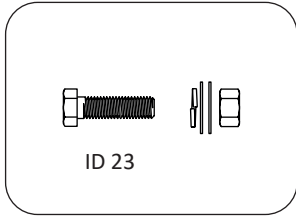

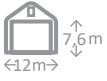

EVEREST 12 m x 12 m, 12 m x 20 m

1 m arch distance

5

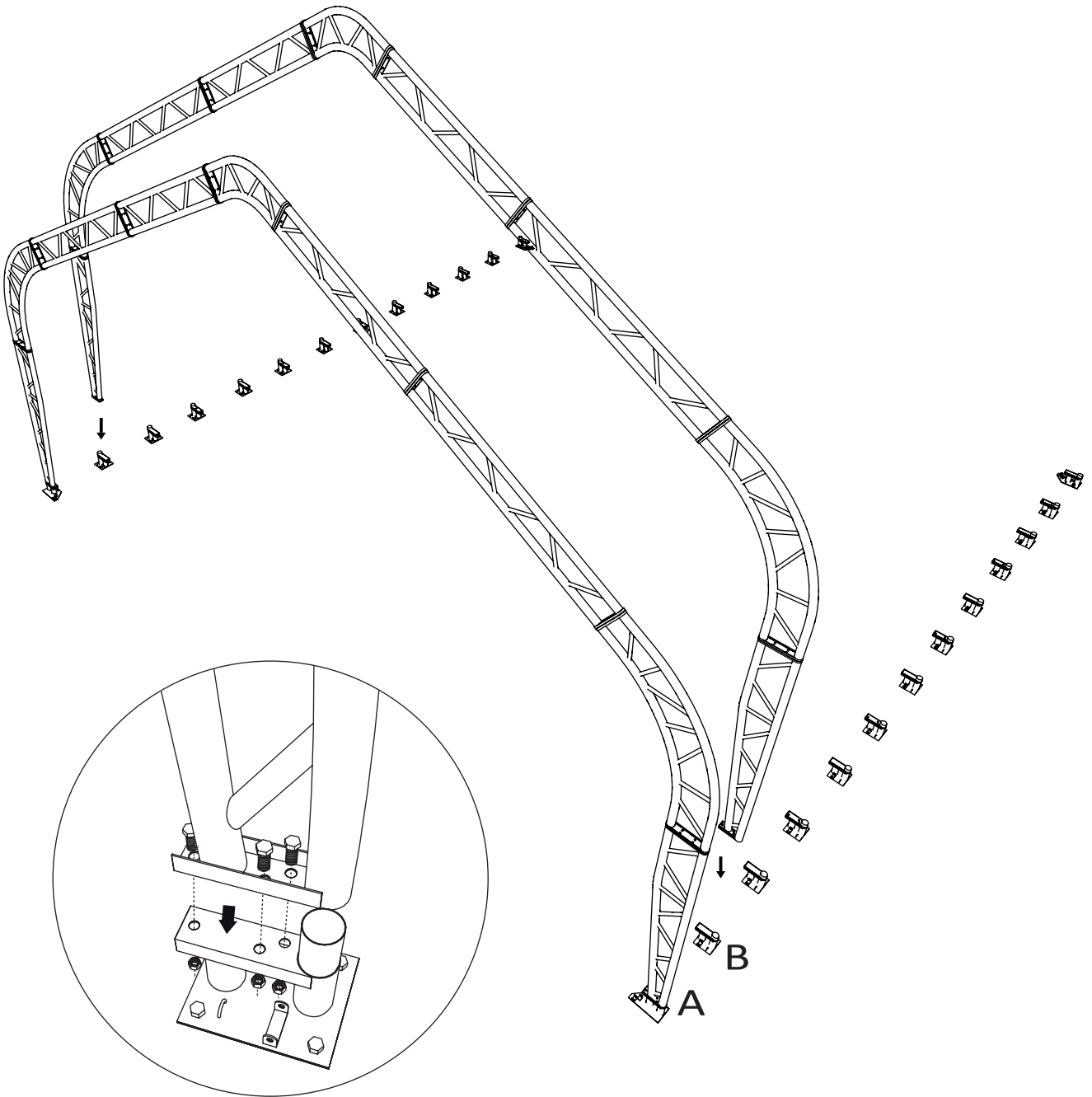
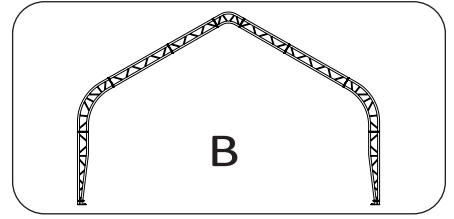
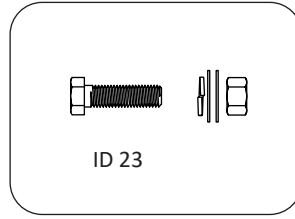

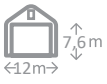

EVEREST 12 m x 12 m, 12 m x 20 m

1 m arch distance

6



ID 24

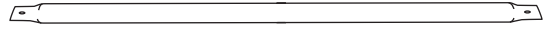

ID 6

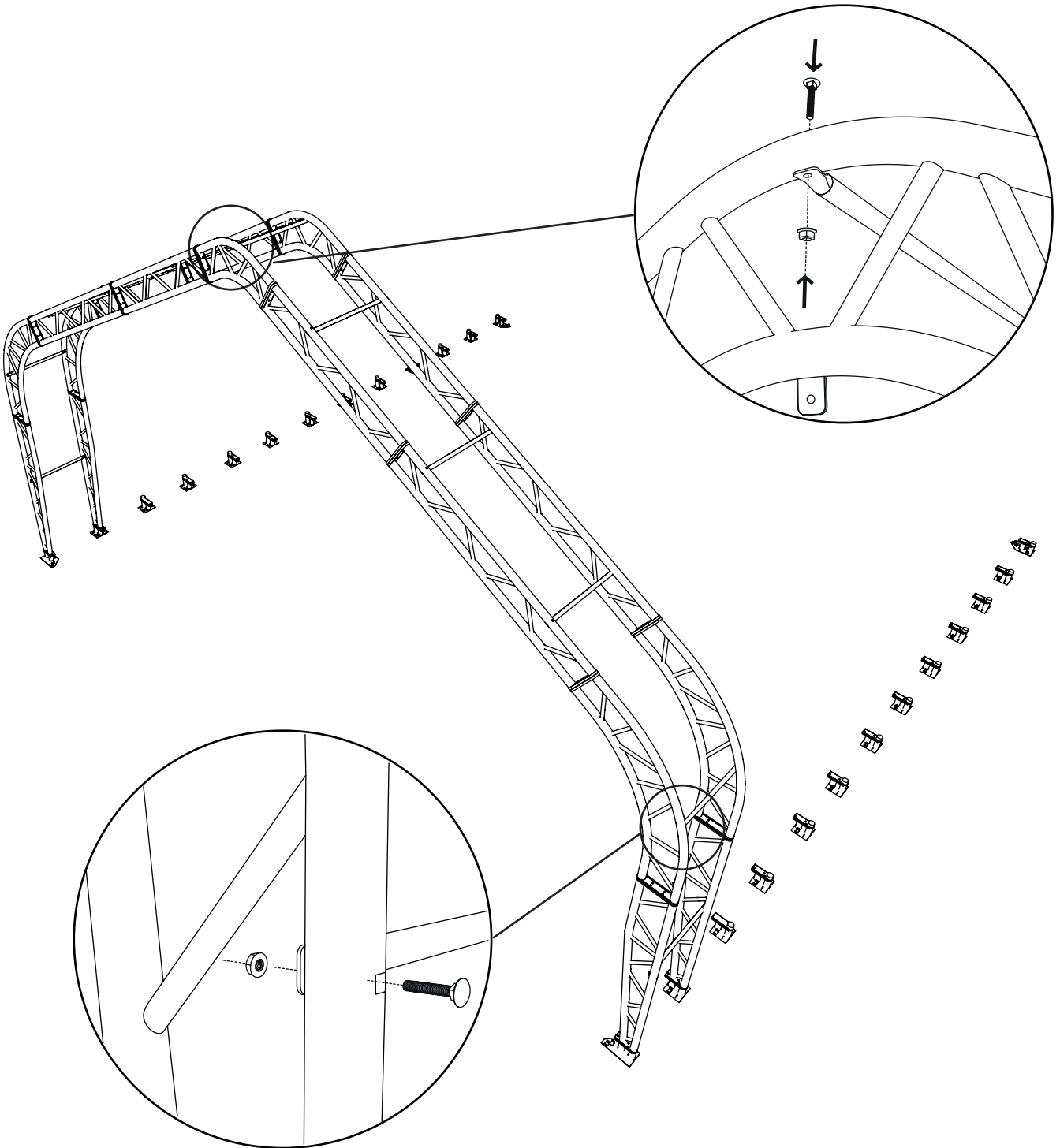

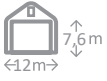

EVEREST 12 m x 12 m, 12 m x 20 m

1 m arch distance

7

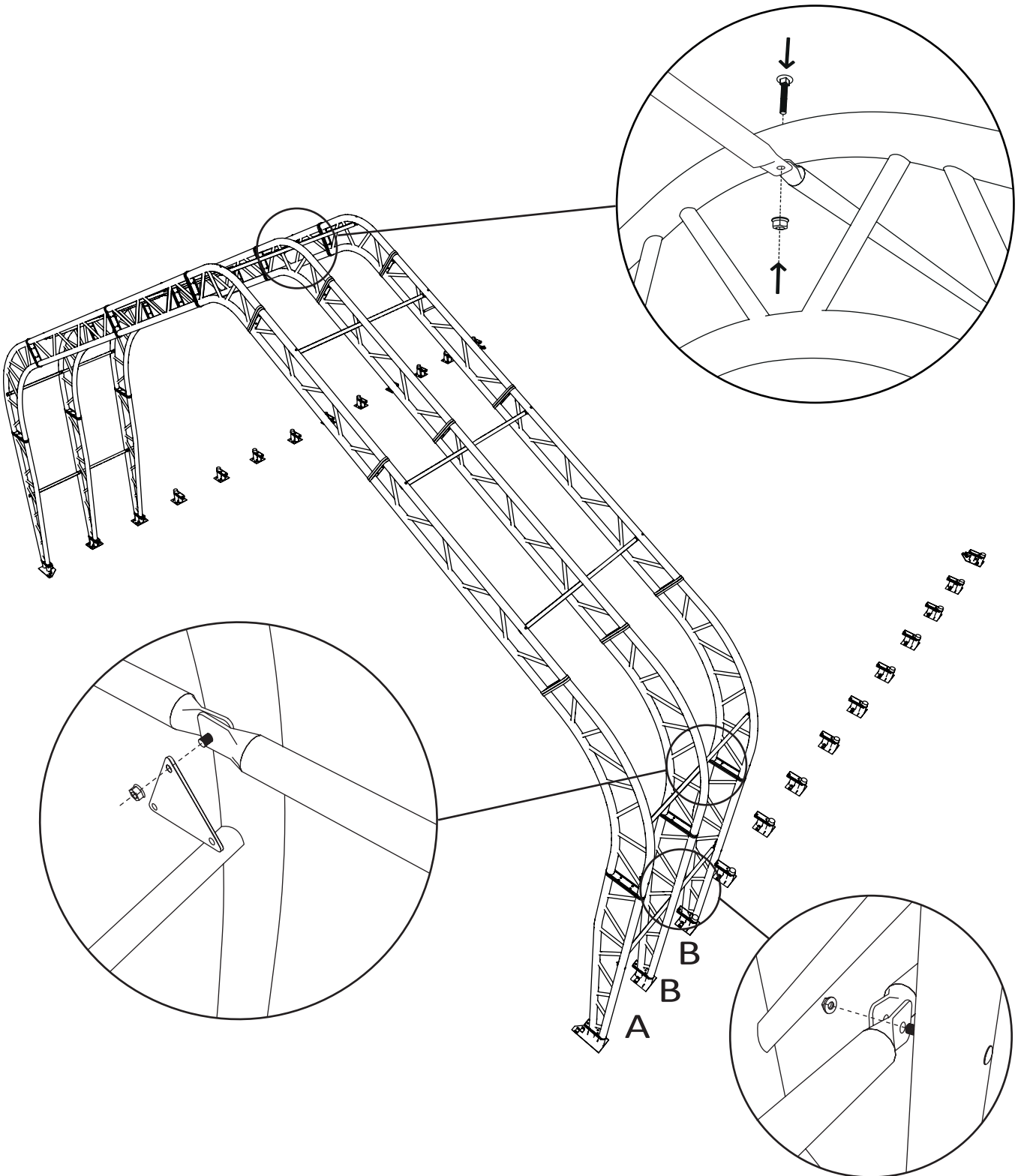
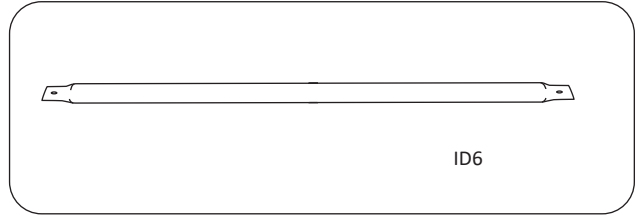
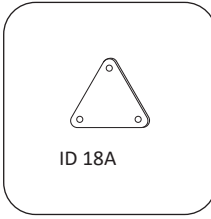
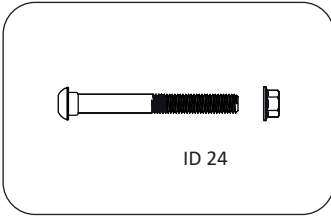

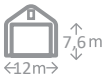

EVEREST 12 m x 12 m, 12 m x 20 m

1 m arch distance

8



ID 24



ID 18A

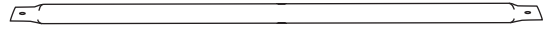

ID 6



ID 19

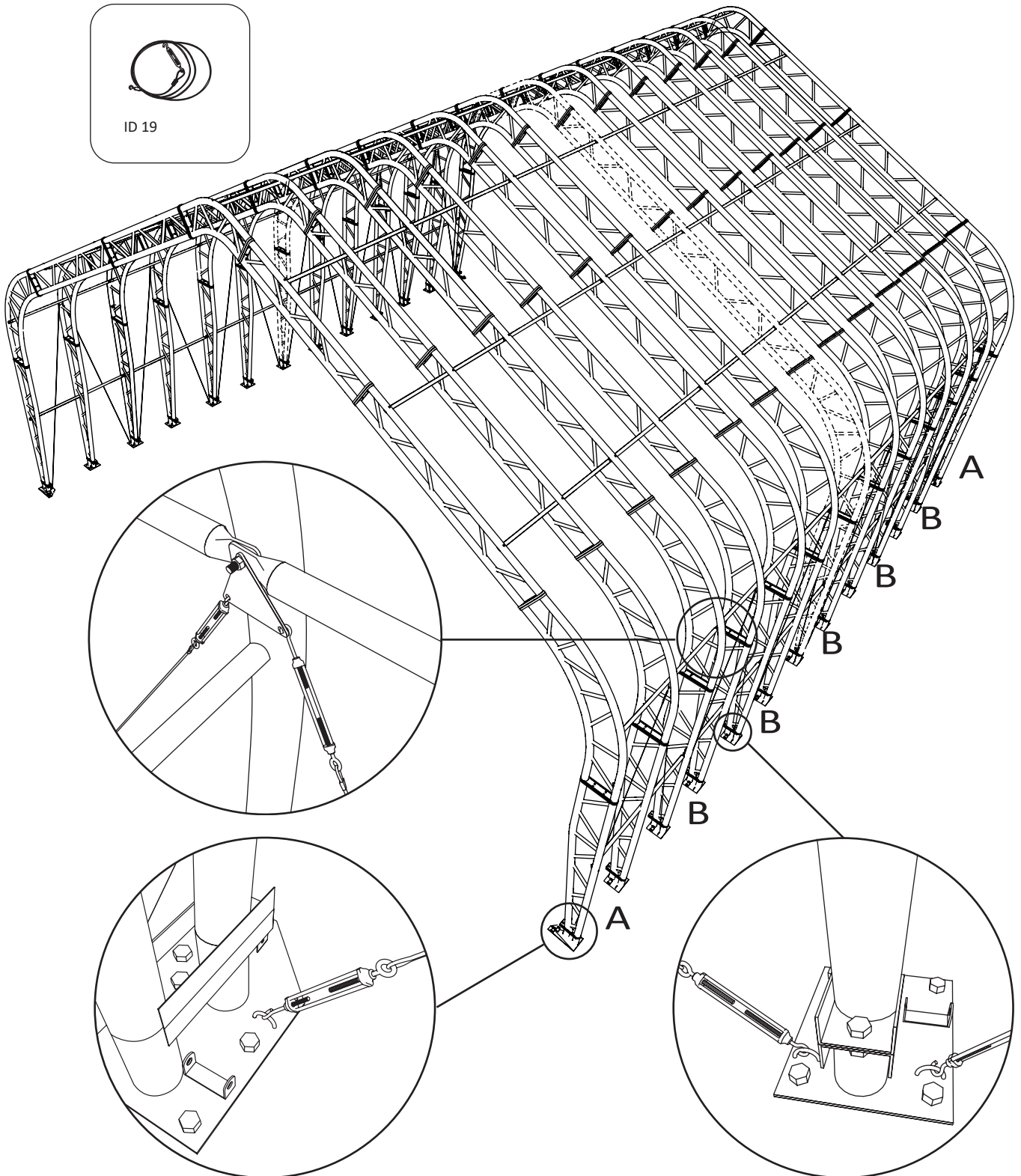

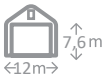

EVEREST 12 m x 12 m, 12 m x 20 m
1 m arch distance

9

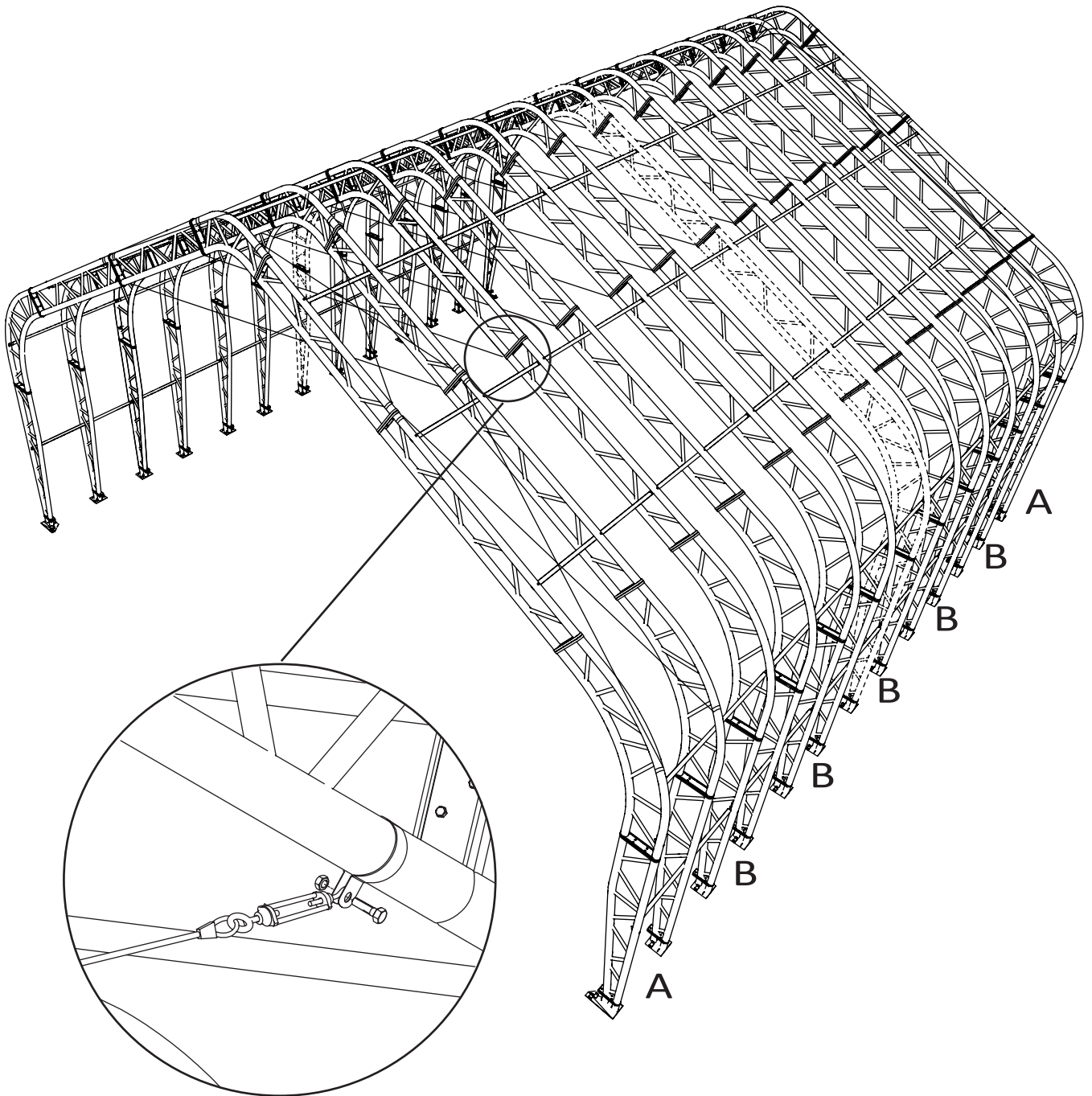
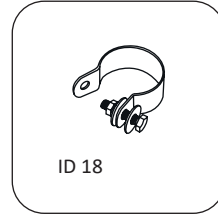

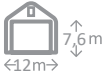

EVEREST 12 m x 12 m, 12 m x 20 m
1 m arch distance

10

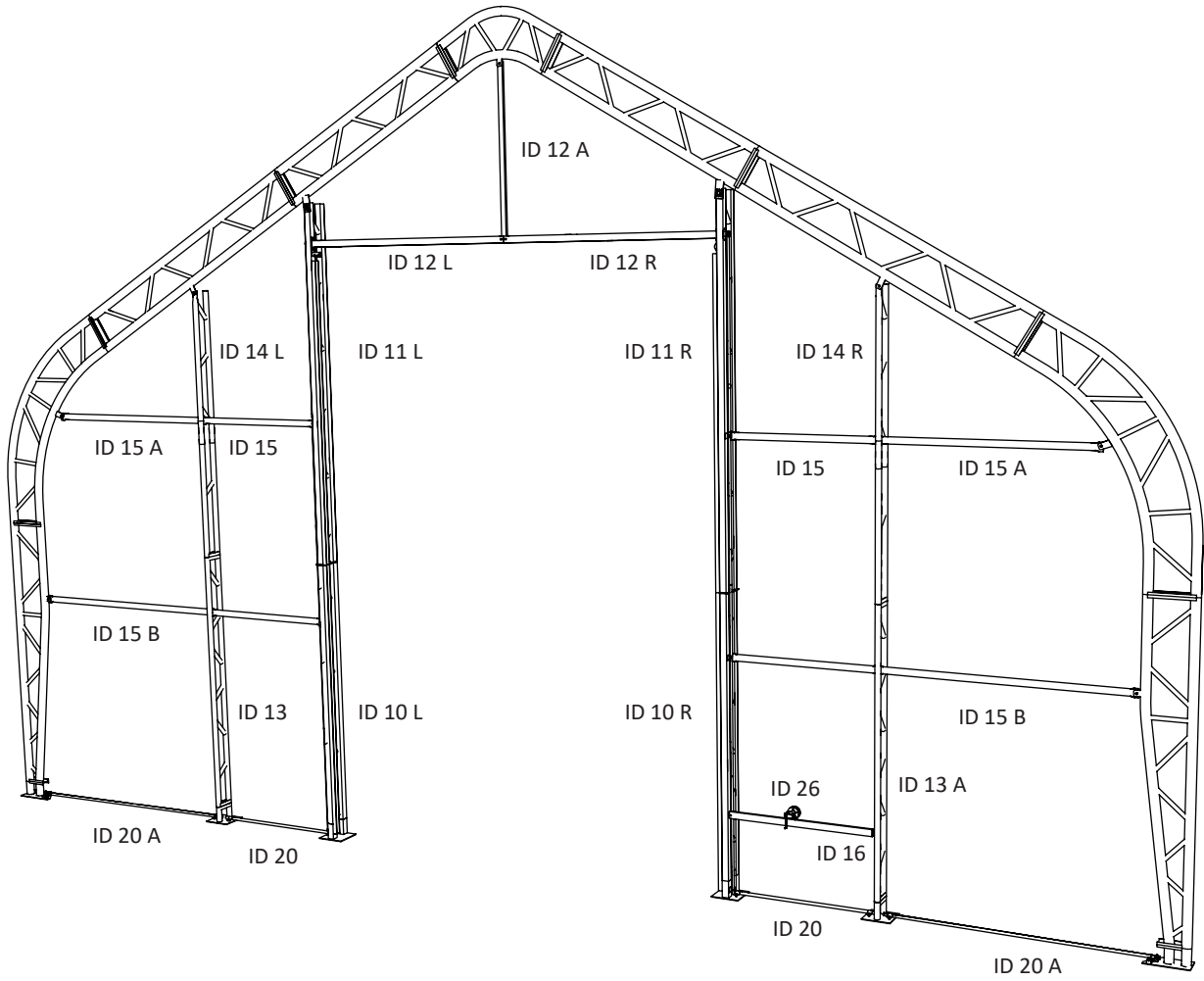

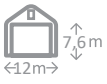

EVEREST 12 m x 12 m, 12 m x 20 m

1 m arch distance

11

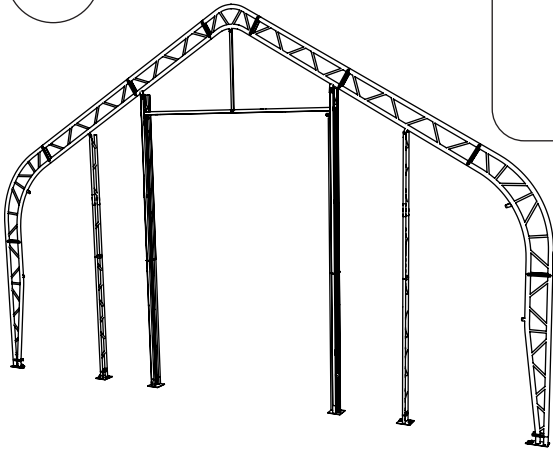

ID 23A



ID 32



ID 24A

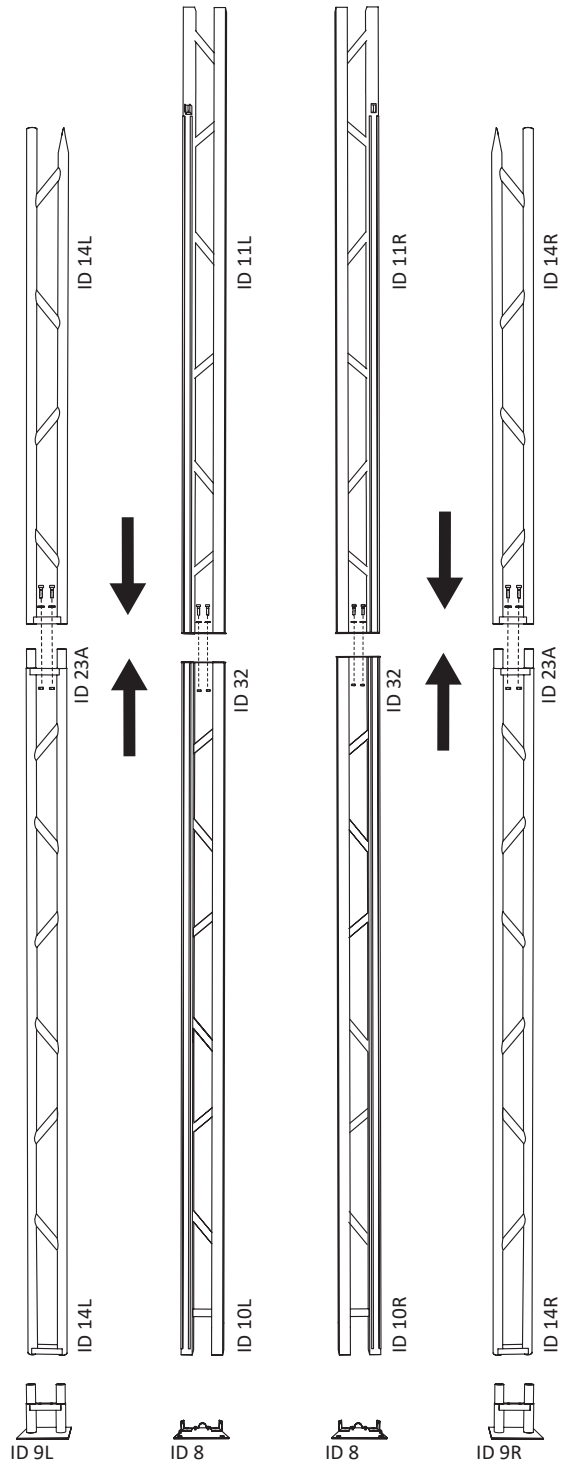
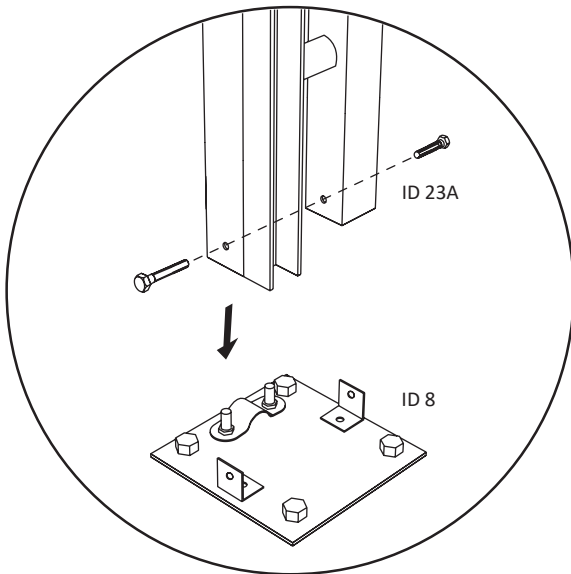
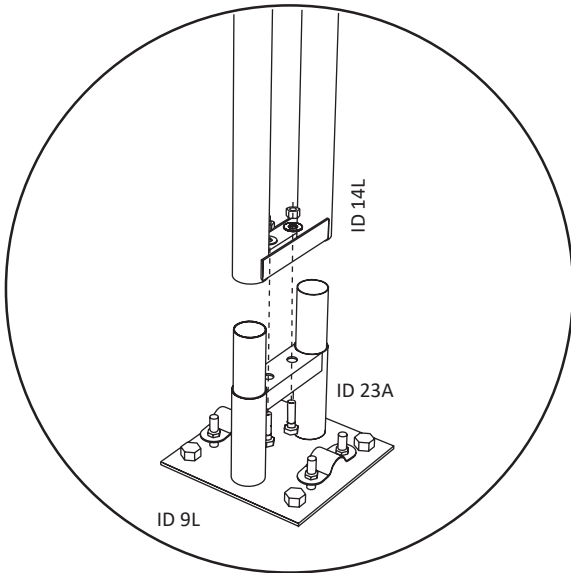

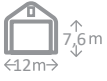

EVEREST 12 m x 12 m, 12 m x 20 m

1 m arch distance

12

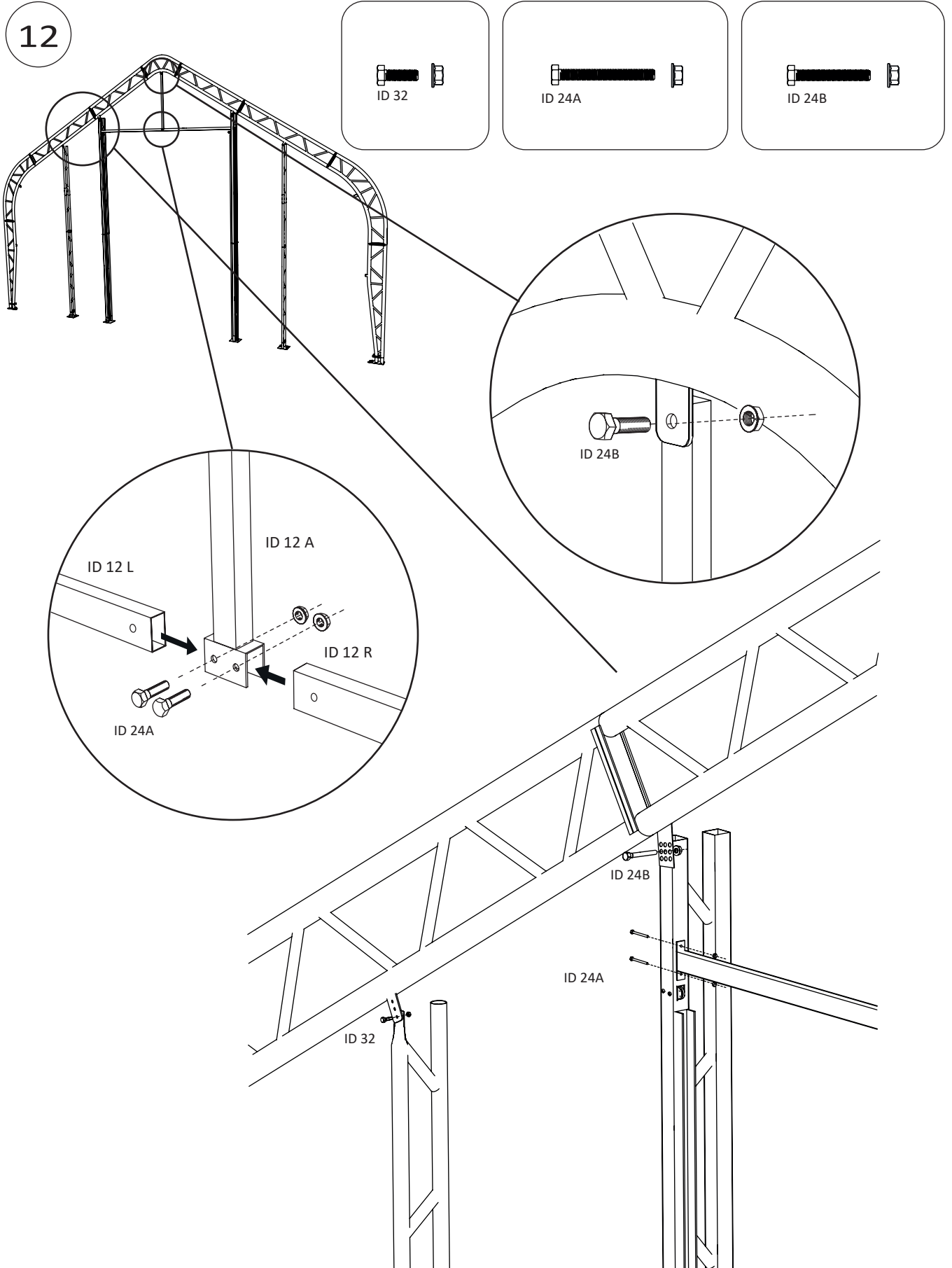

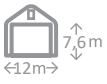

EVEREST 12 m x 12 m, 12 m x 20 m

1 m arch distance

13

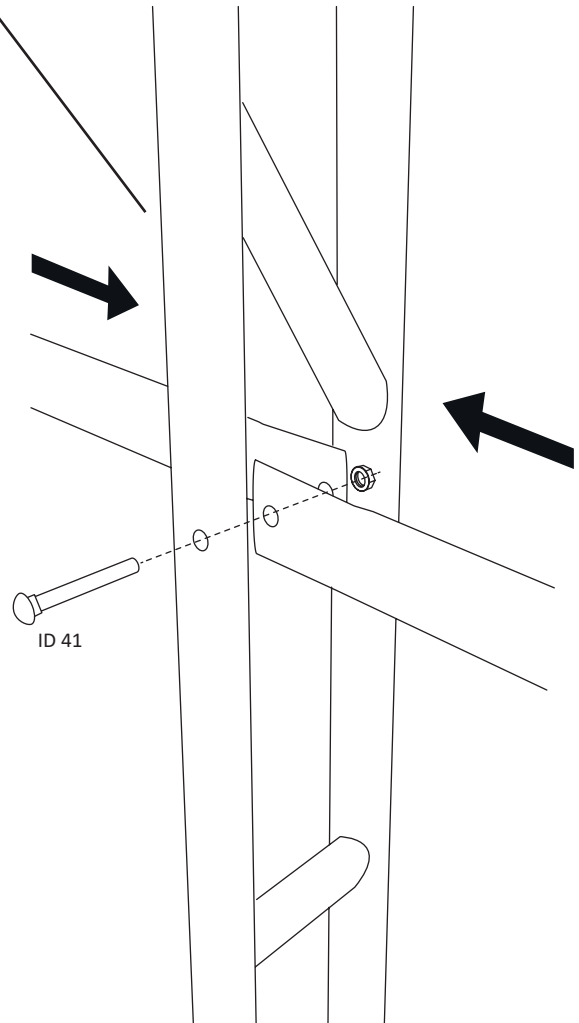
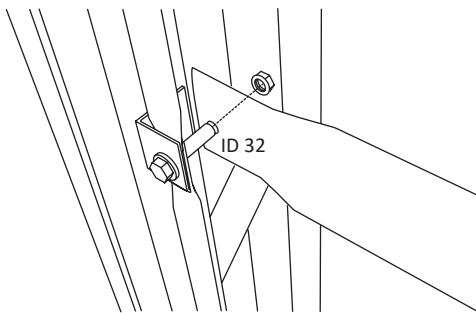
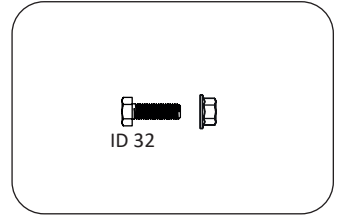
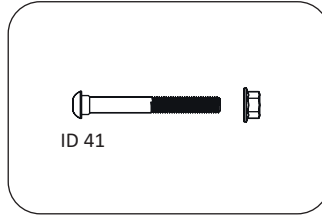
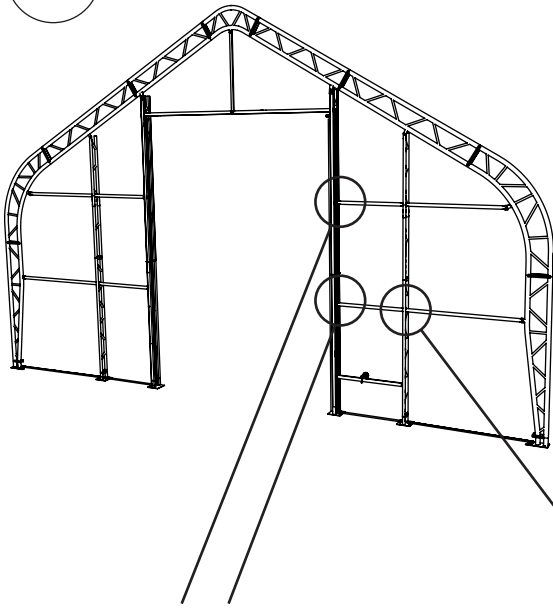

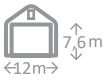

EVEREST 12 m x 12 m, 12 m x 20 m

1 m arch distance

14

2 x ID 27 + ID 20

1 x ID 27 + ID 20A

ID 24A

ID 32

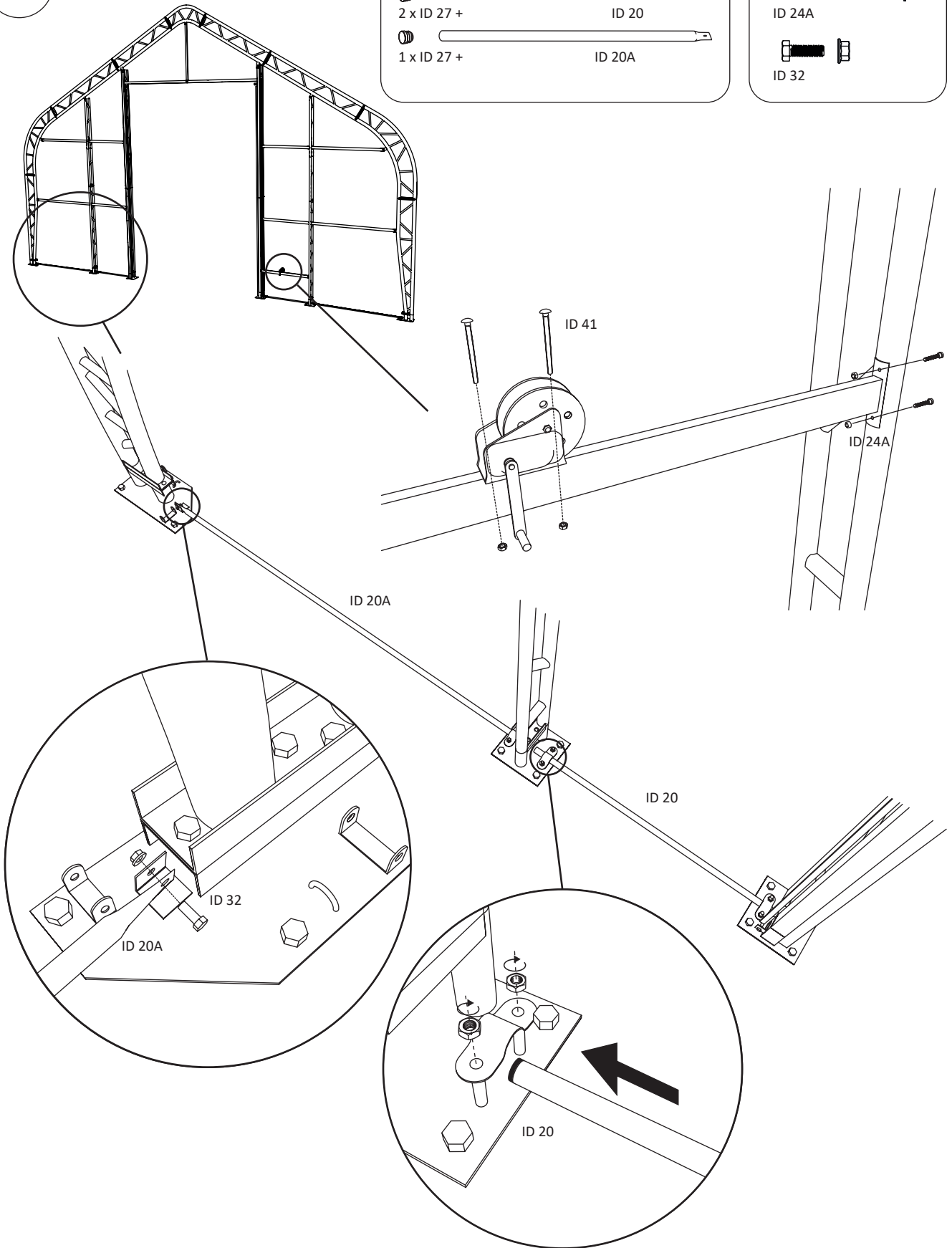

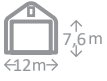

EVEREST 12 m x 12 m, 12 m x 20 m

1 m arch distance

15

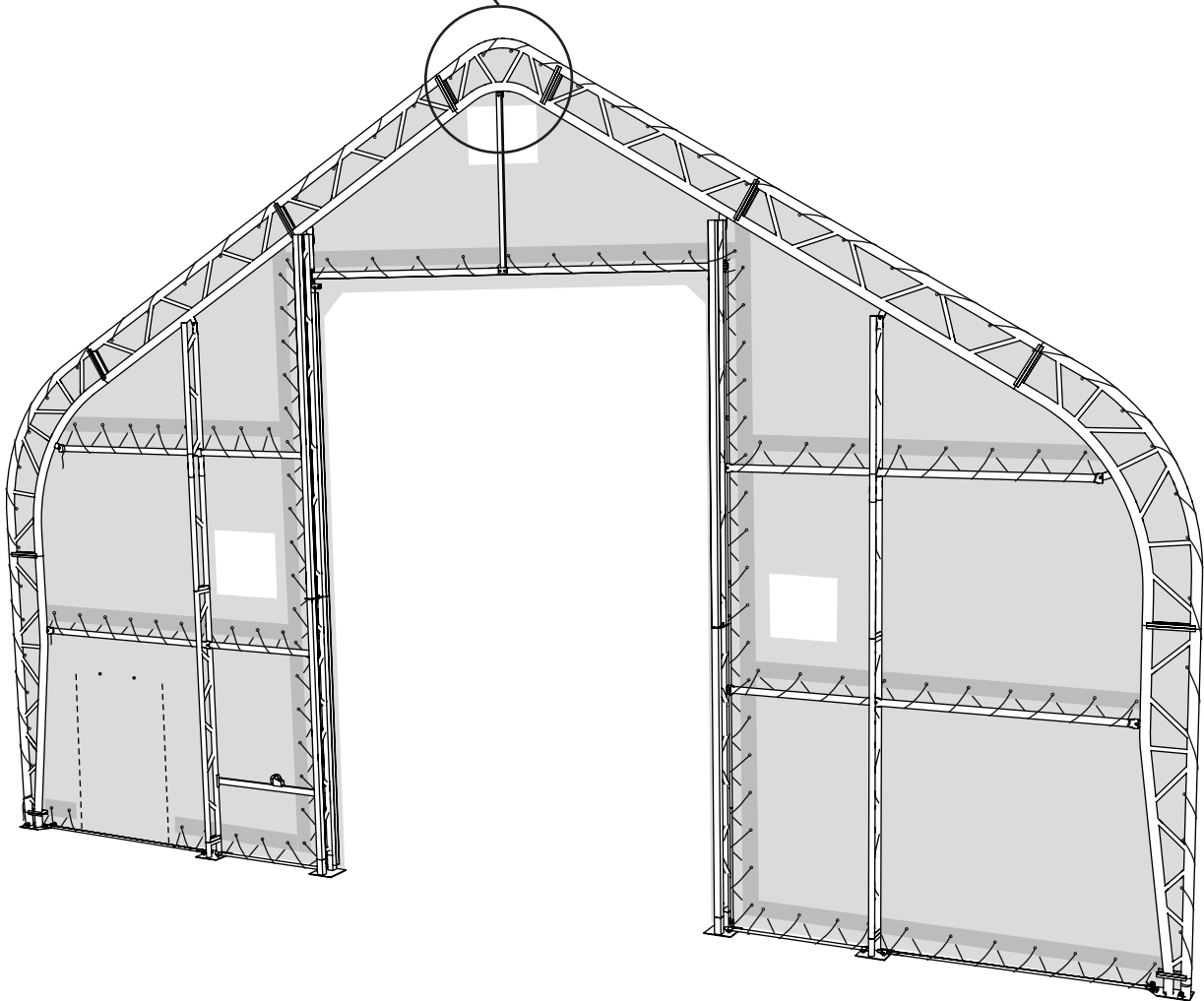
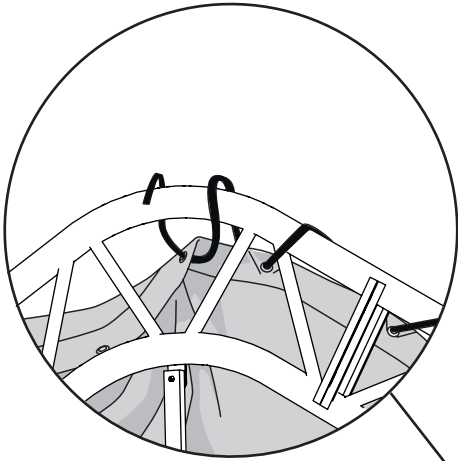
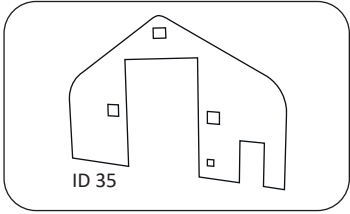
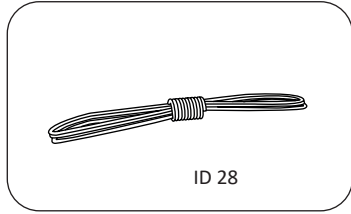

! view inside

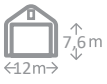

EVEREST 12 m x 12 m, 12 m x 20 m

1 m arch distance

16



ID 25B

ID 25A

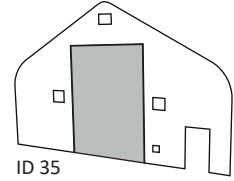

ID 35

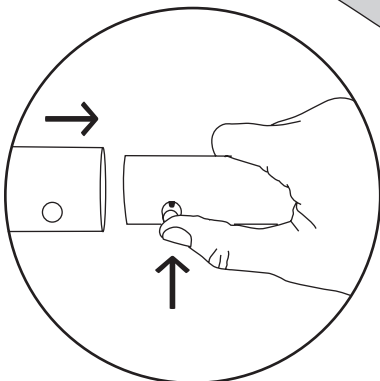
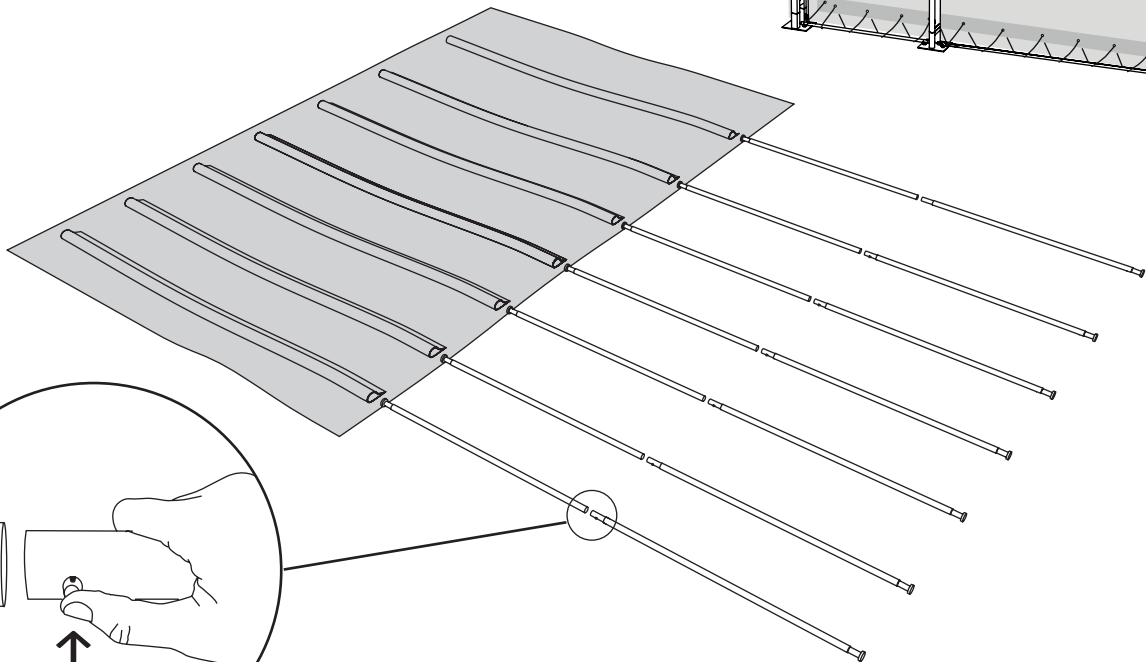
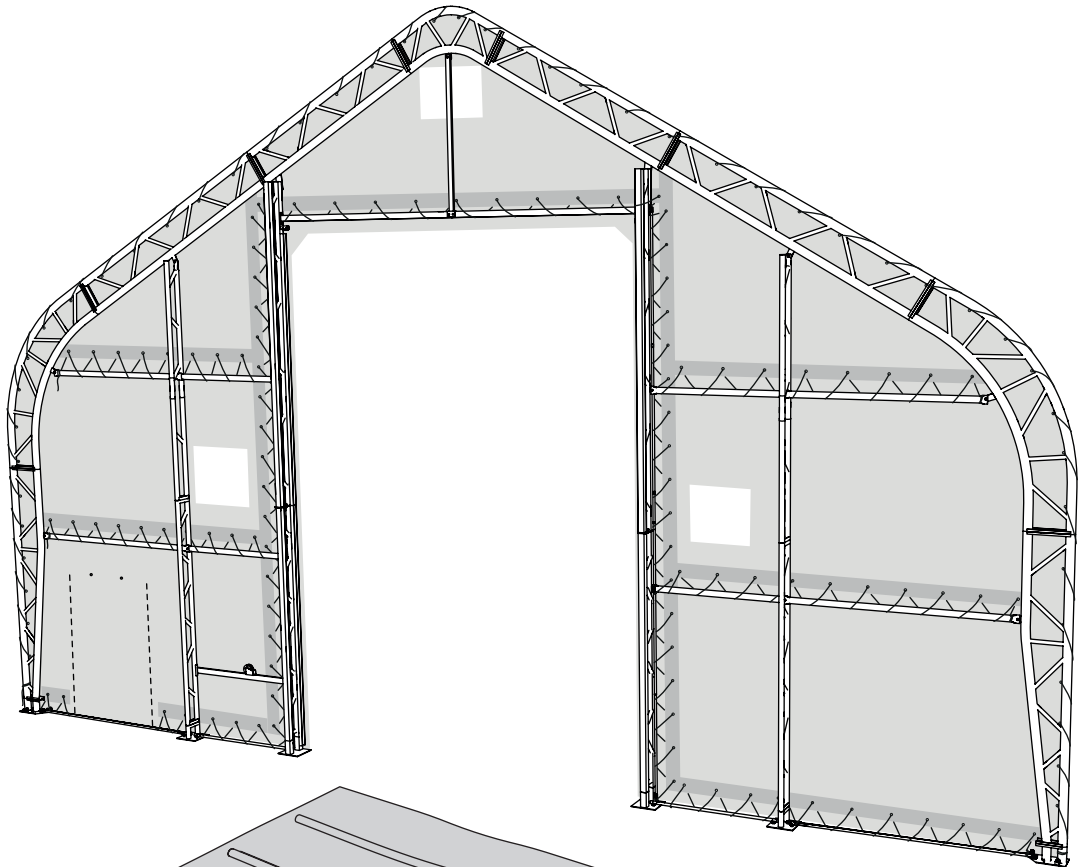

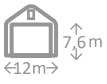

EVEREST 12 m x 12 m, 12 m x 20 m
1 m arch distance

17

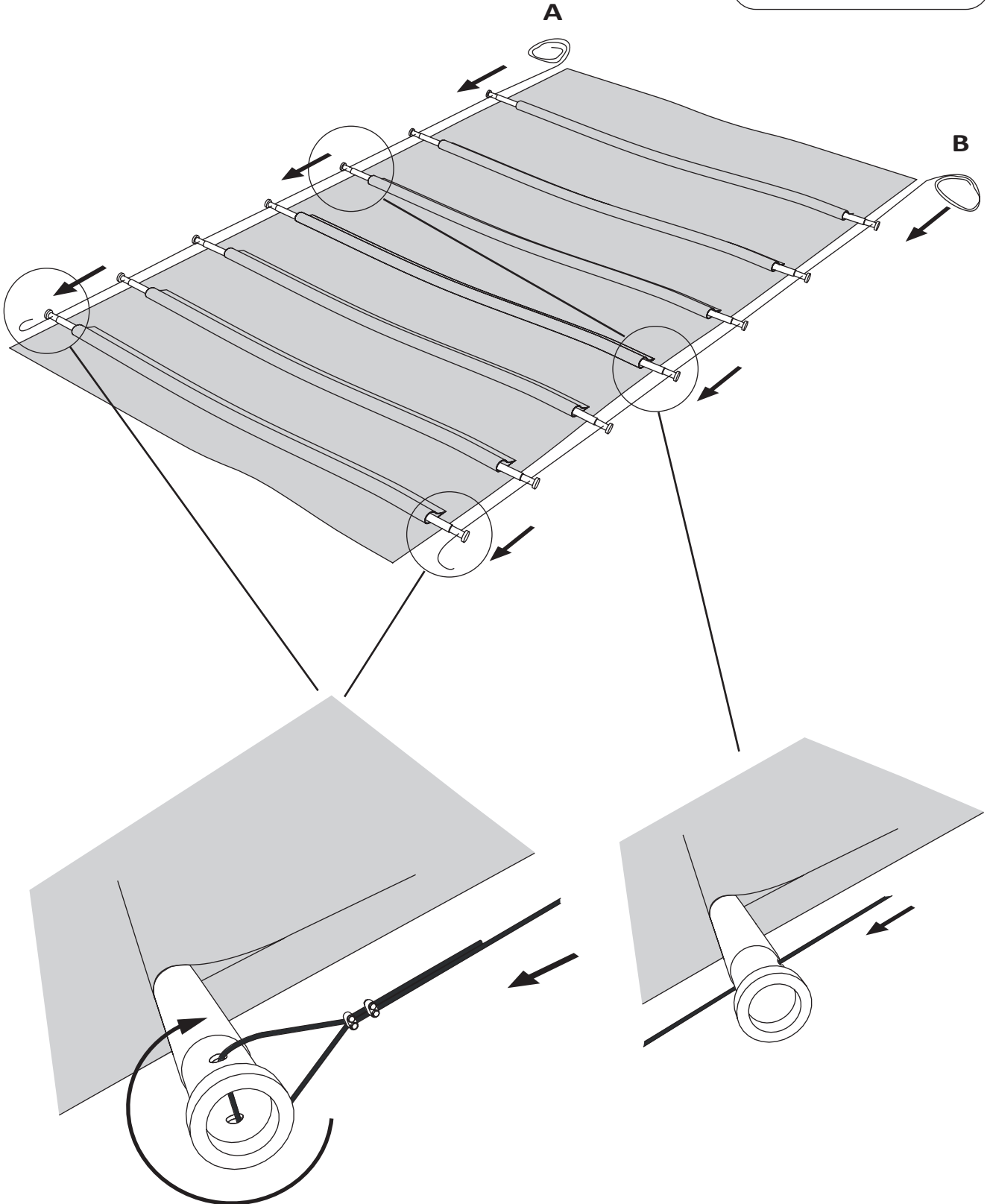
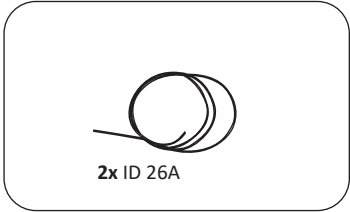

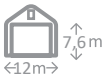

EVEREST 12 m x 12 m, 12 m x 20 m

1 m arch distance

18

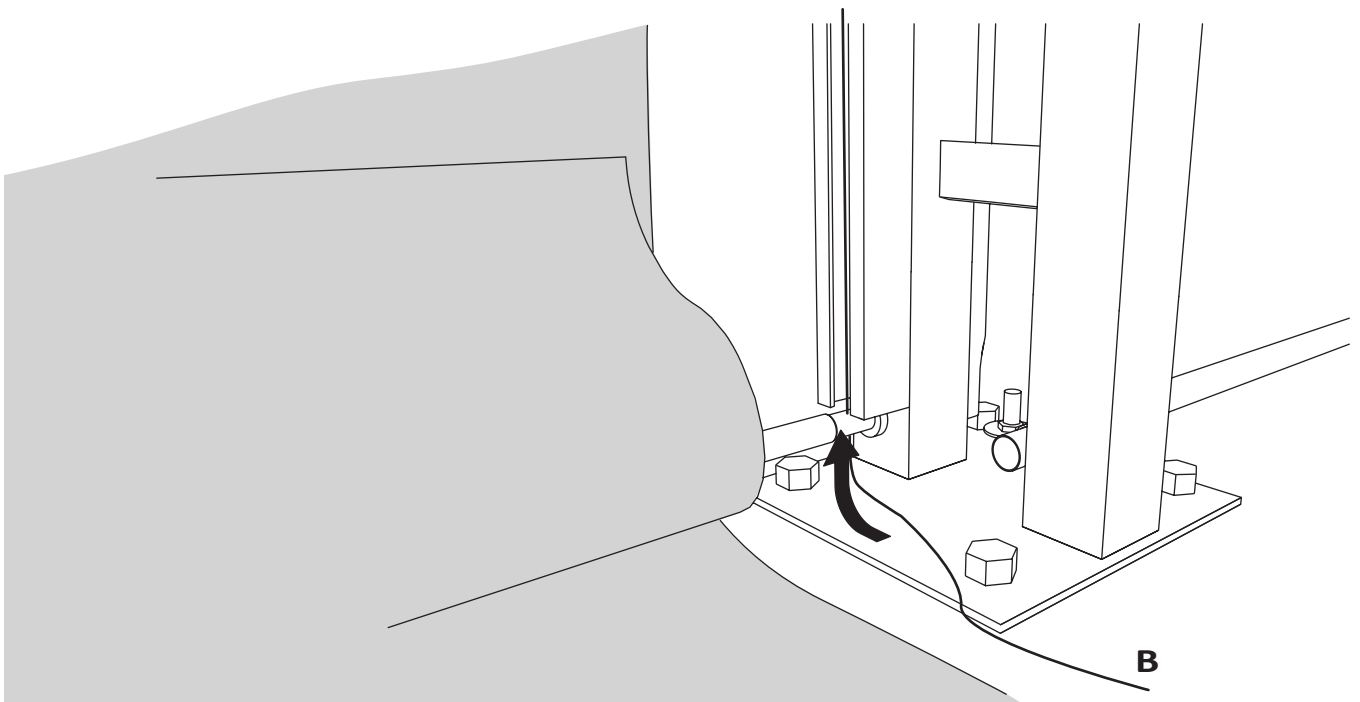
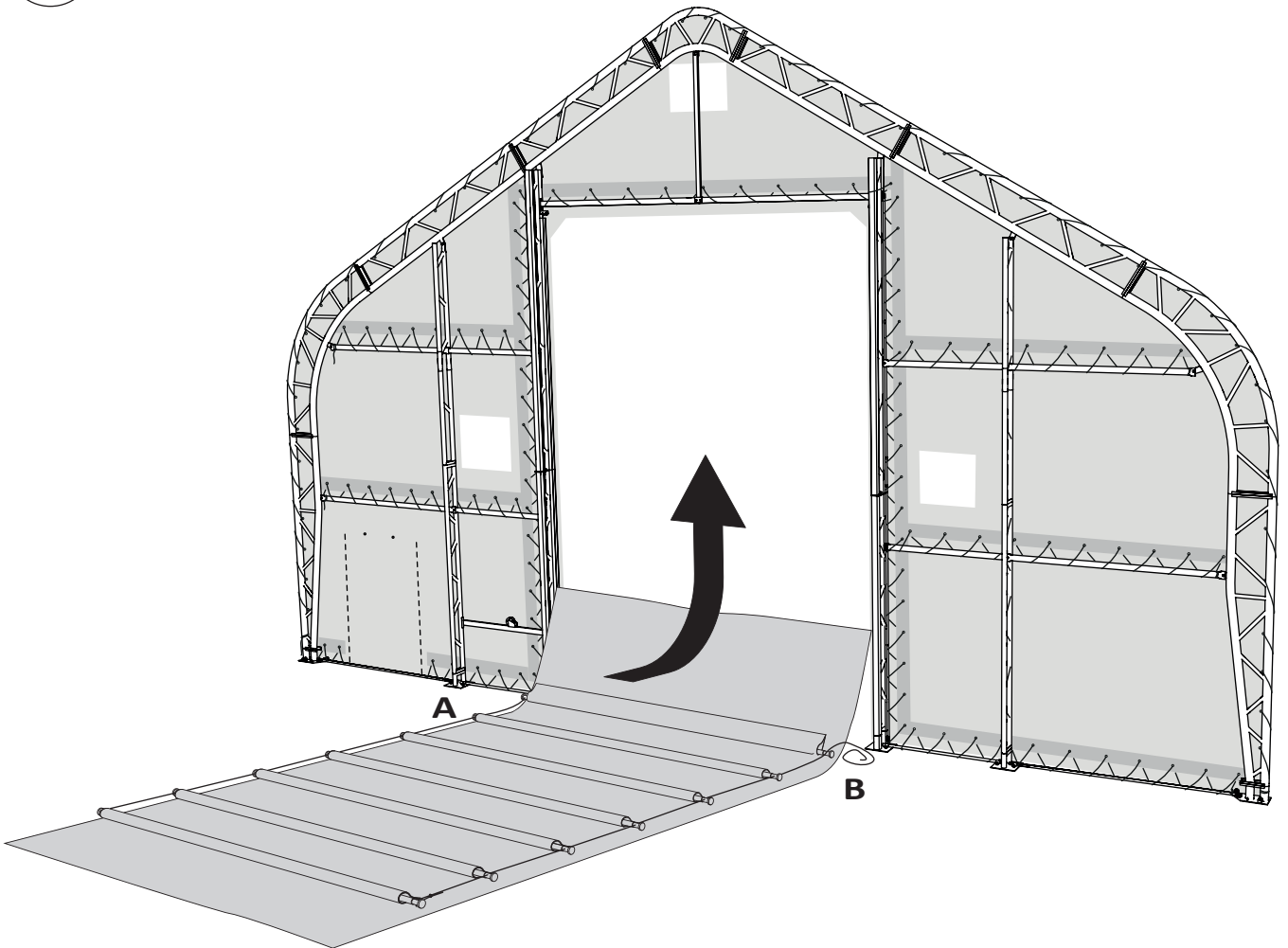

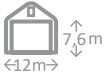

EVEREST 12 m x 12 m, 12 m x 20 m
1 m arch distance

19



ID 28

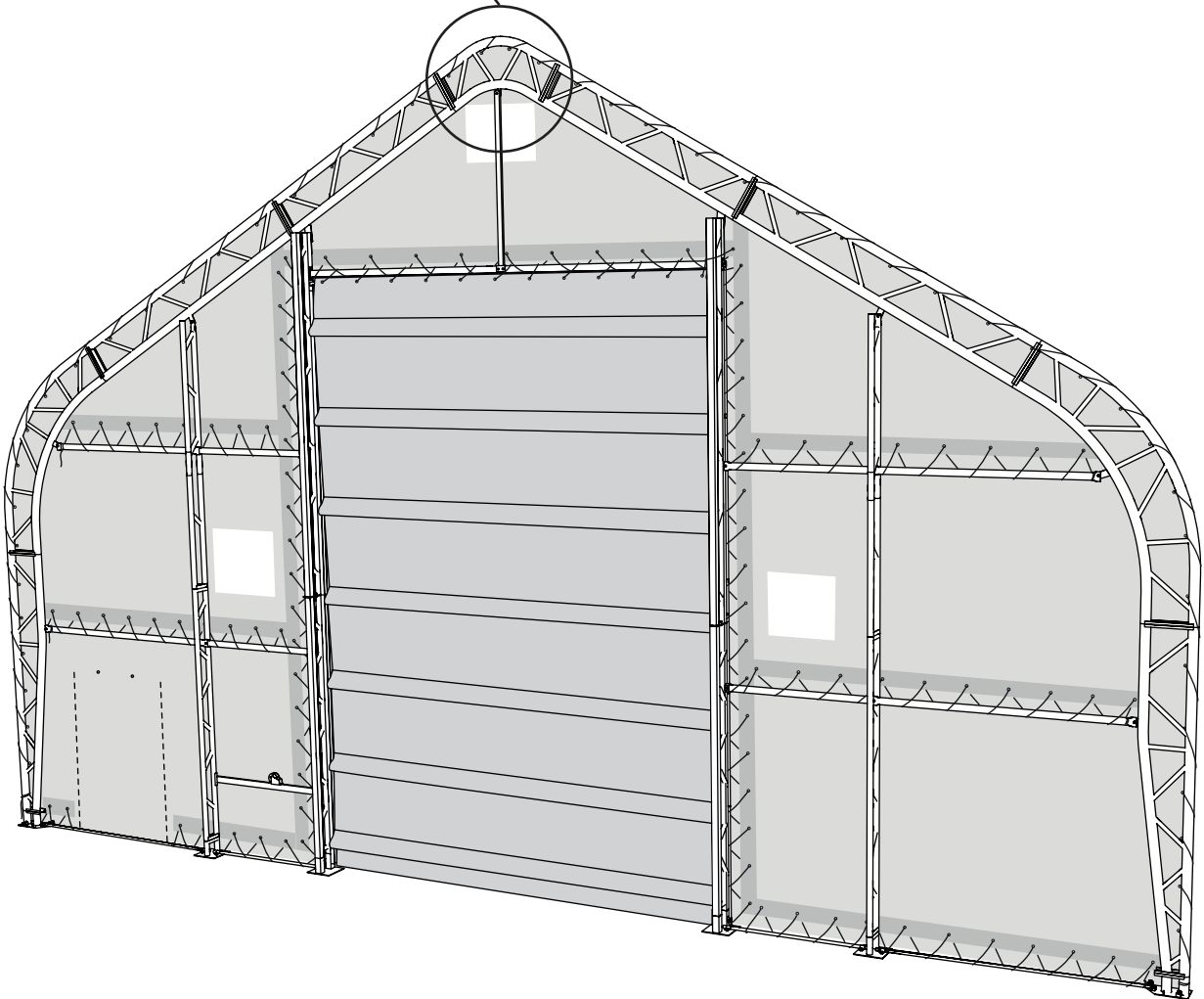
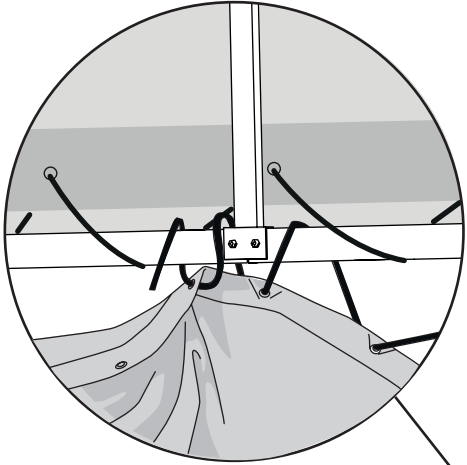

! view inside

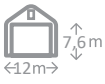

EVEREST 12 m x 12 m, 12 m x 20 m
1 m arch distance

20

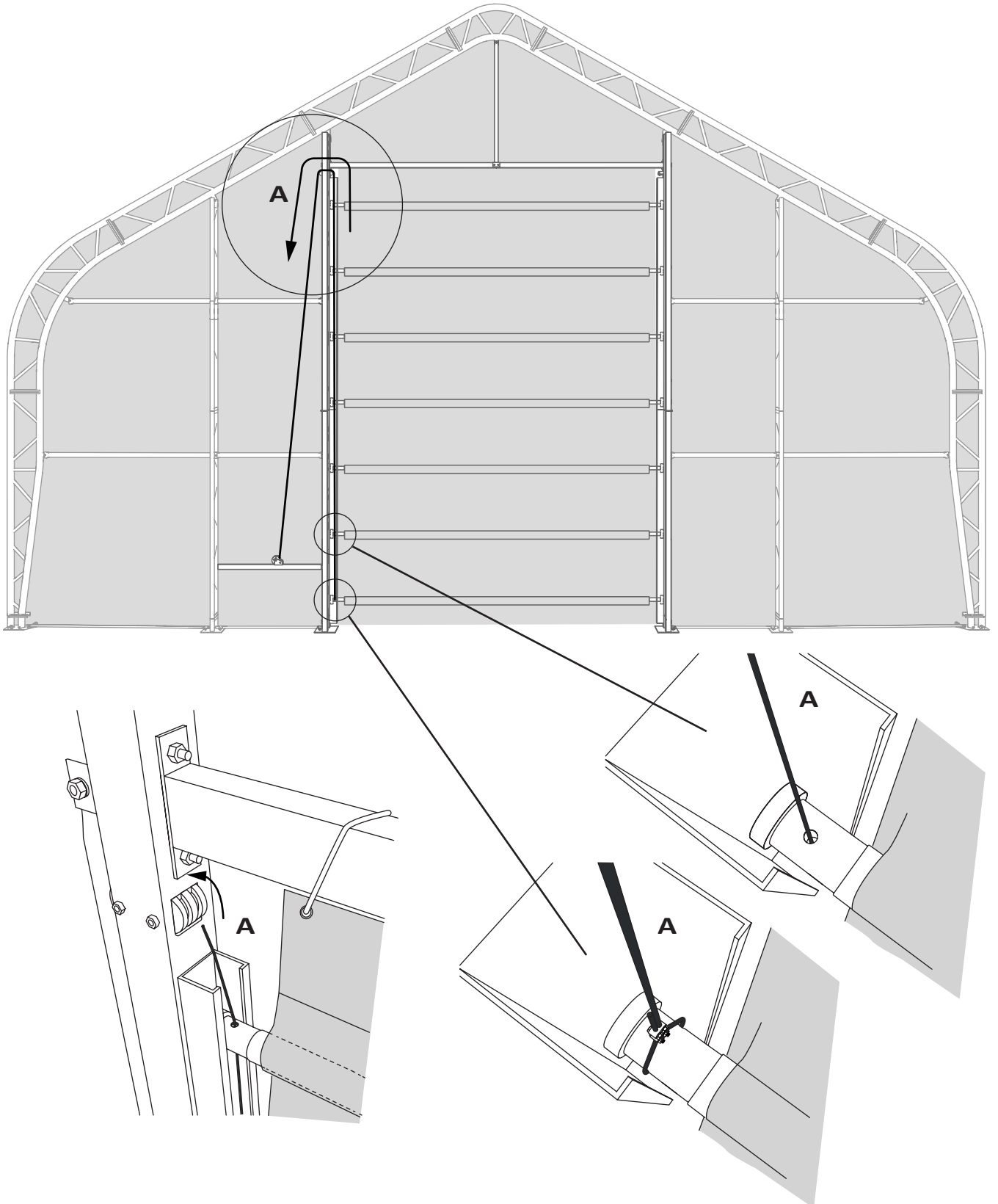

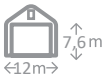

EVEREST 12 m x 12 m, 12 m x 20 m
1 m arch distance

21

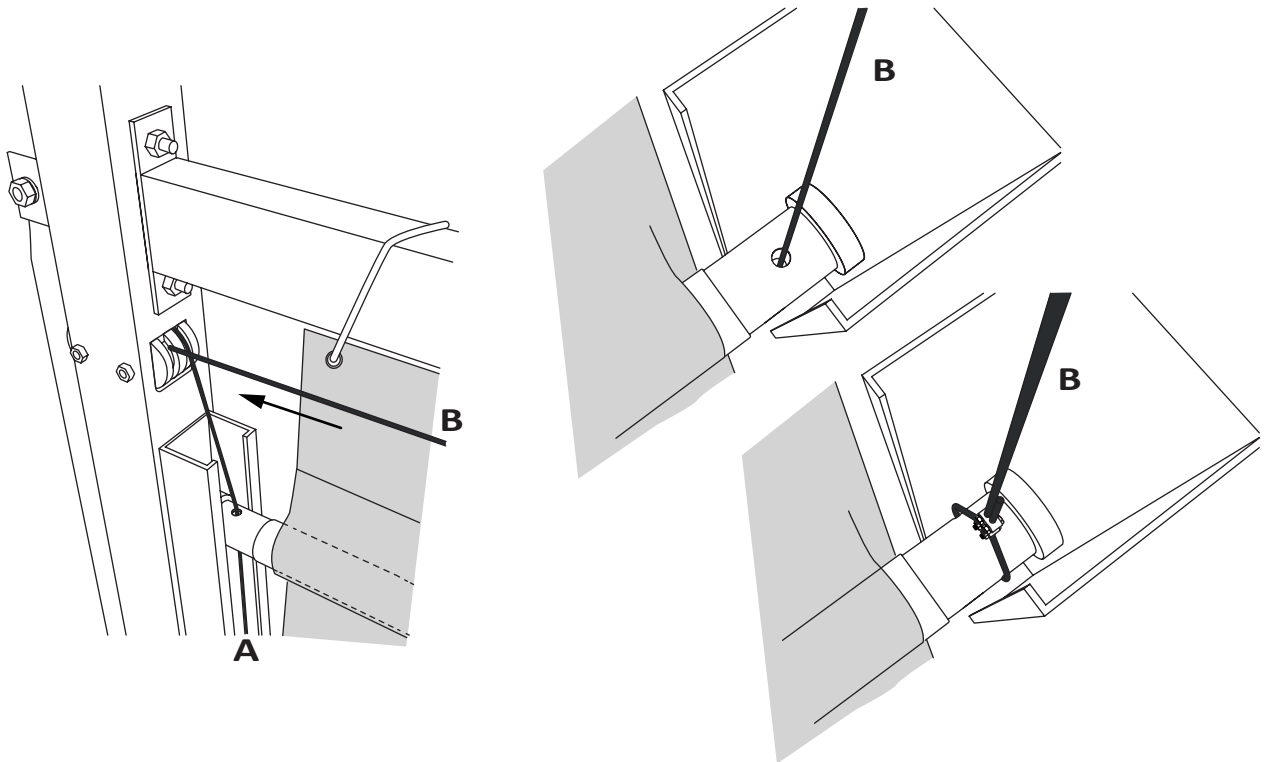
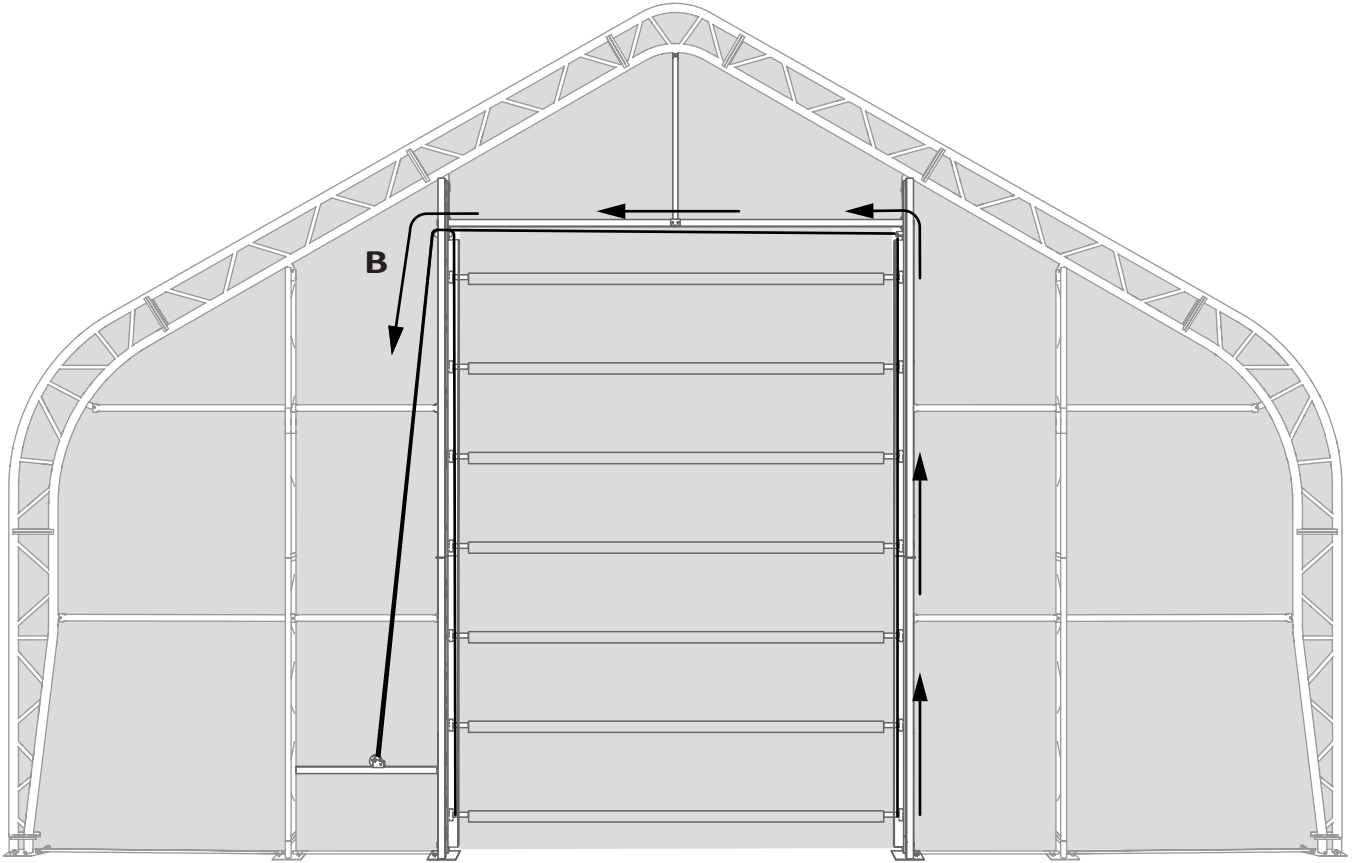

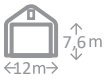

EVEREST 12 m x 12 m, 12 m x 20 m

1 m arch distance

22

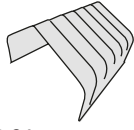

ID 34



ID 27



ID 22 A

1x

ID 22B



ID 27

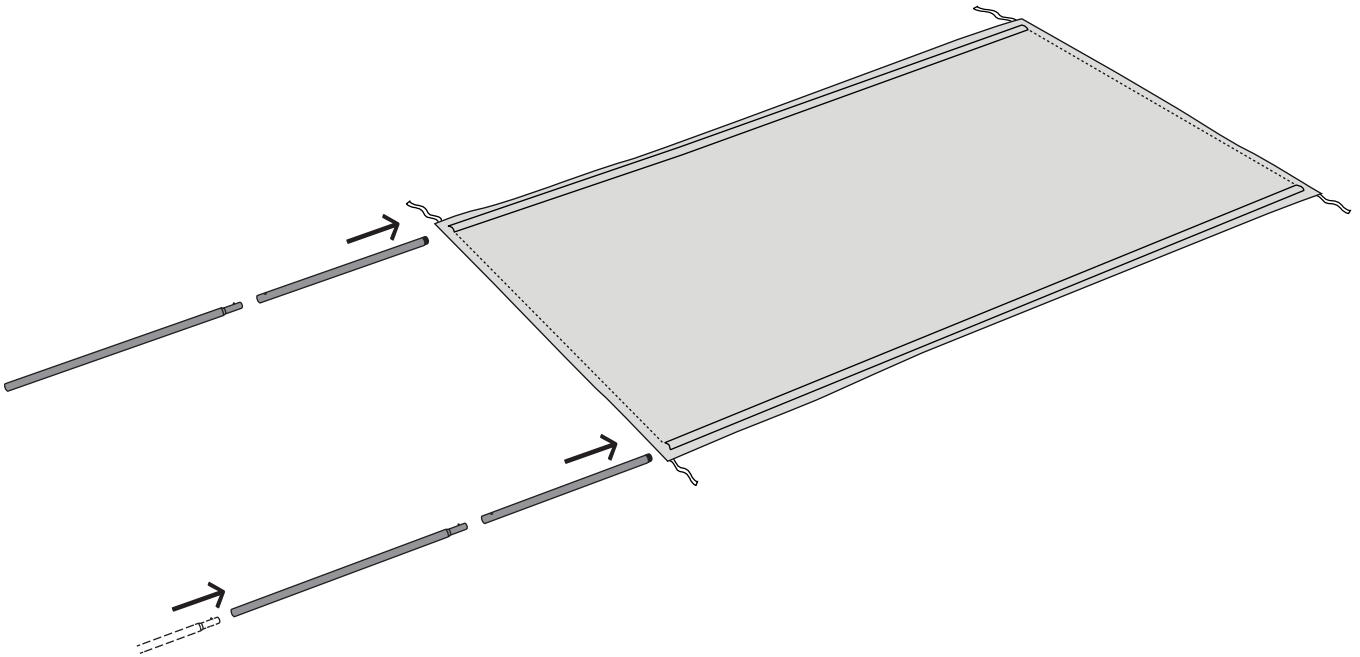

23

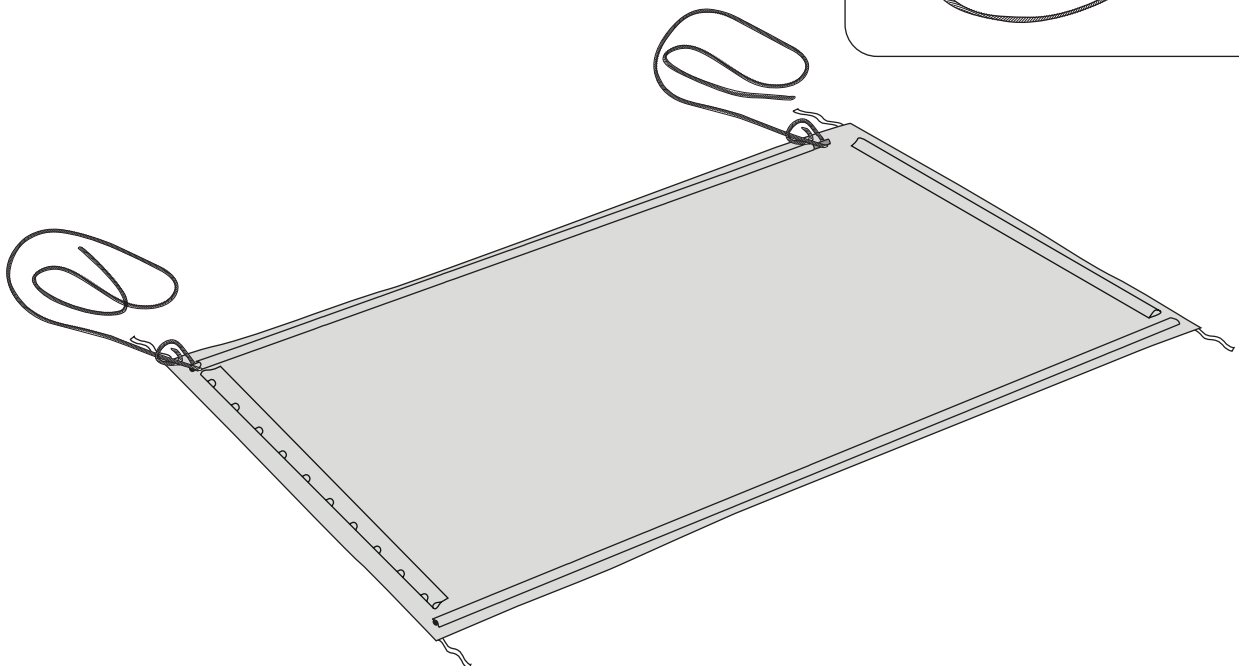
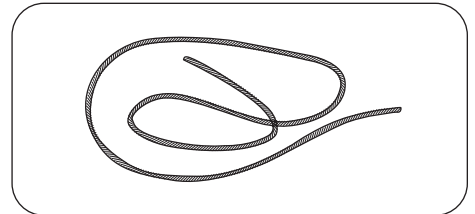

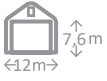

EVEREST 12 m x 12 m, 12 m x 20 m

1 m arch distance

24

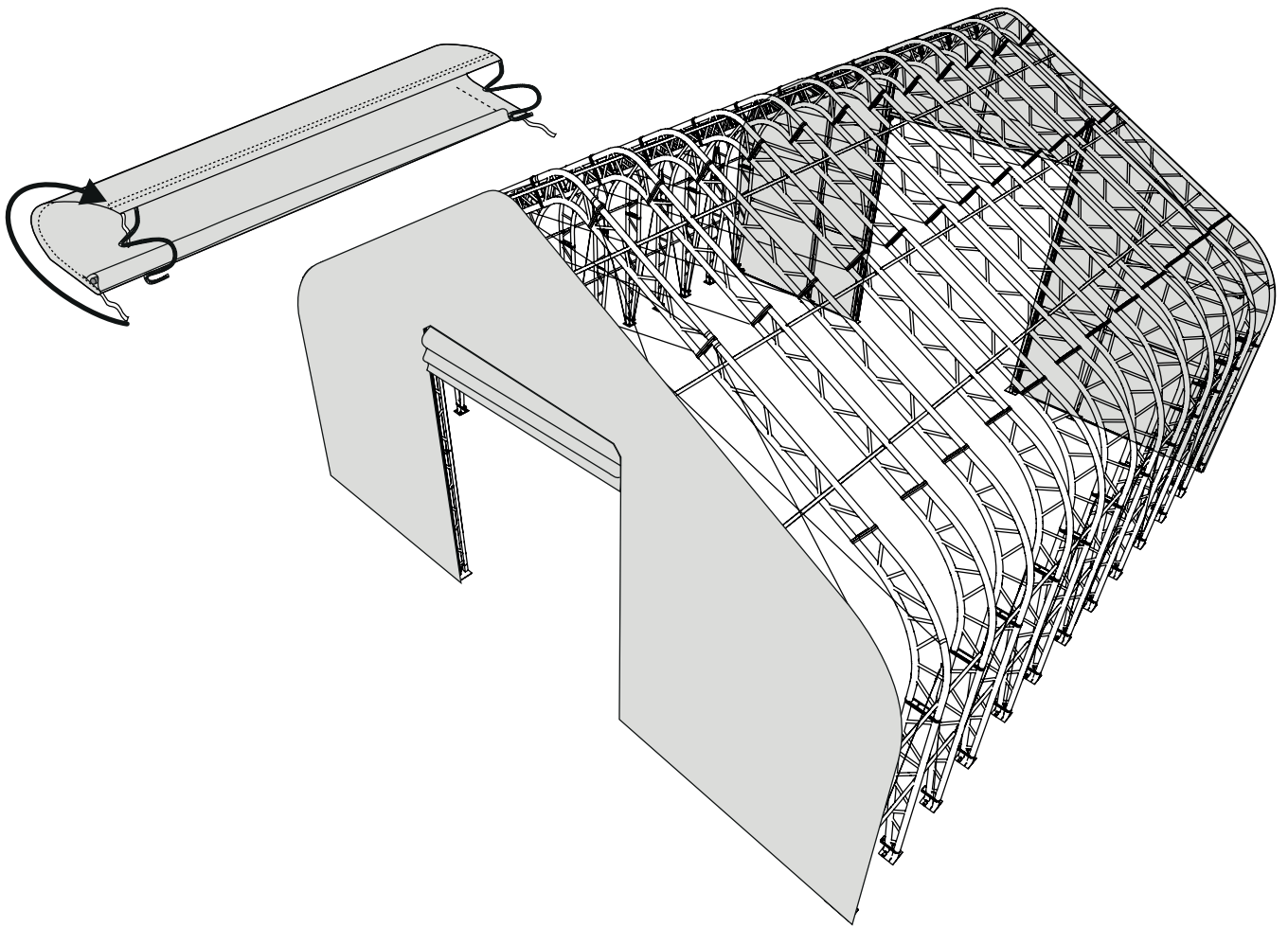

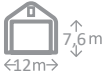

EVEREST 12 m x 12 m, 12 m x 20 m
1 m arch distance

25

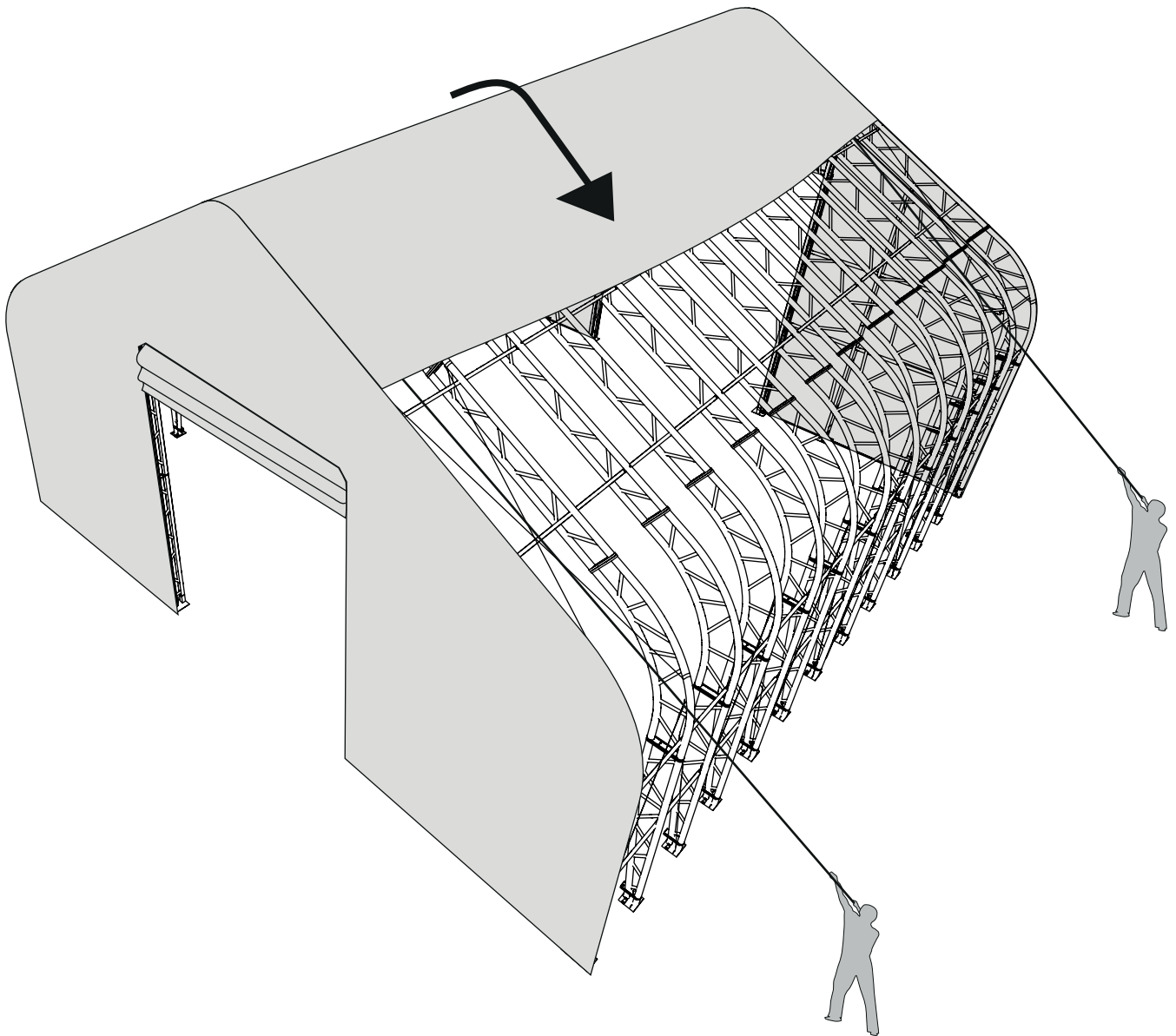

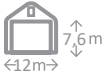

EVEREST 12 m x 12 m, 12 m x 20 m

1 m arch distance

26

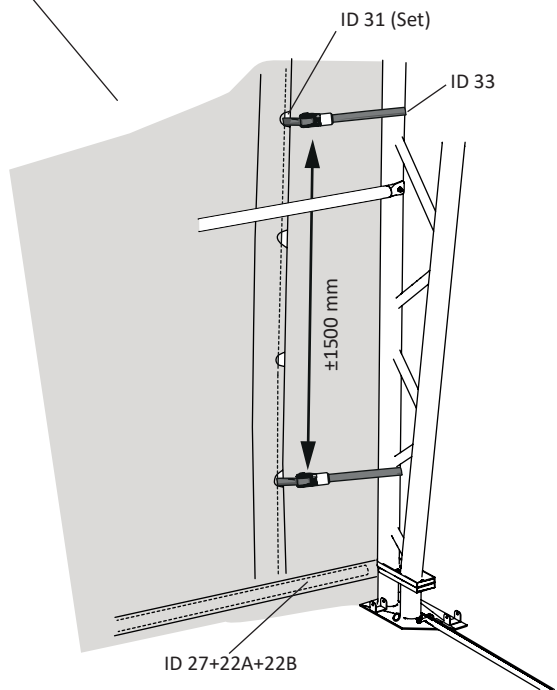
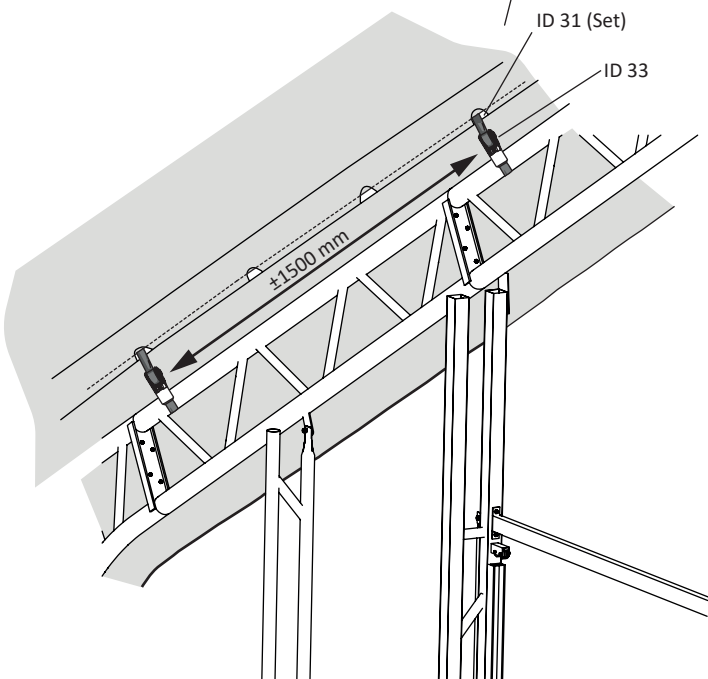
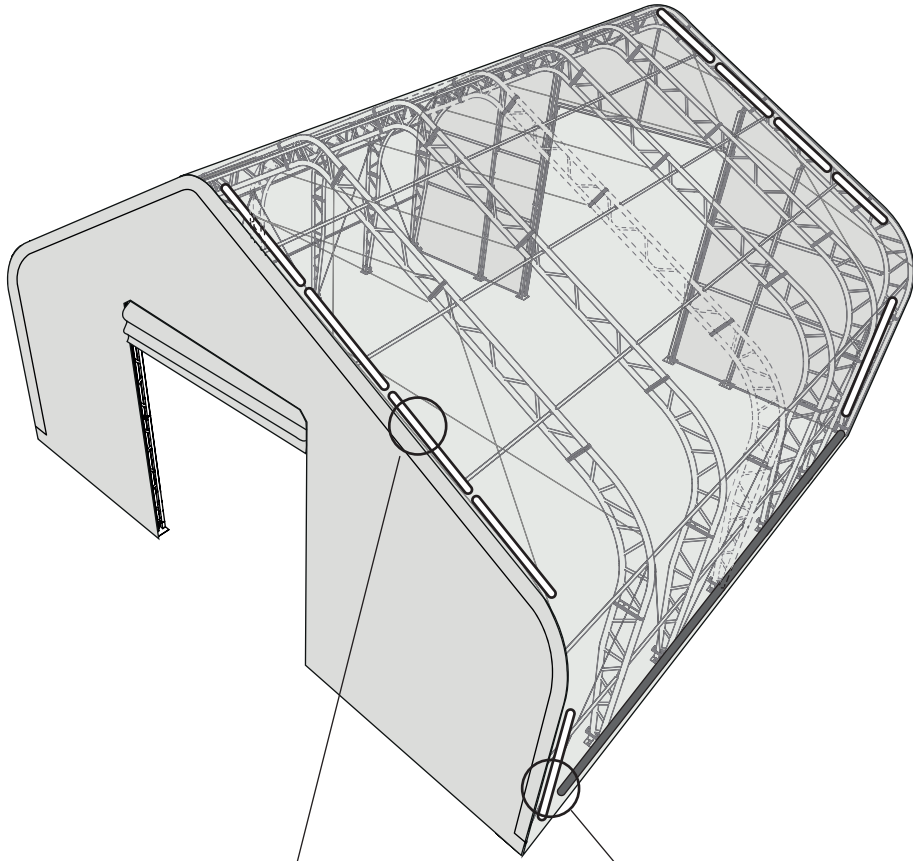
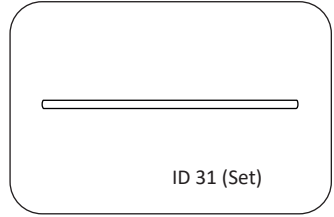
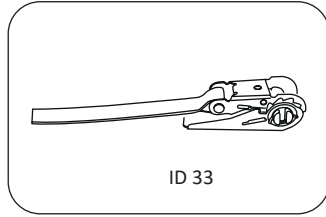

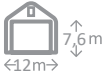

EVEREST 12 m x 12 m, 12 m x 20 m
1 m arch distance

27

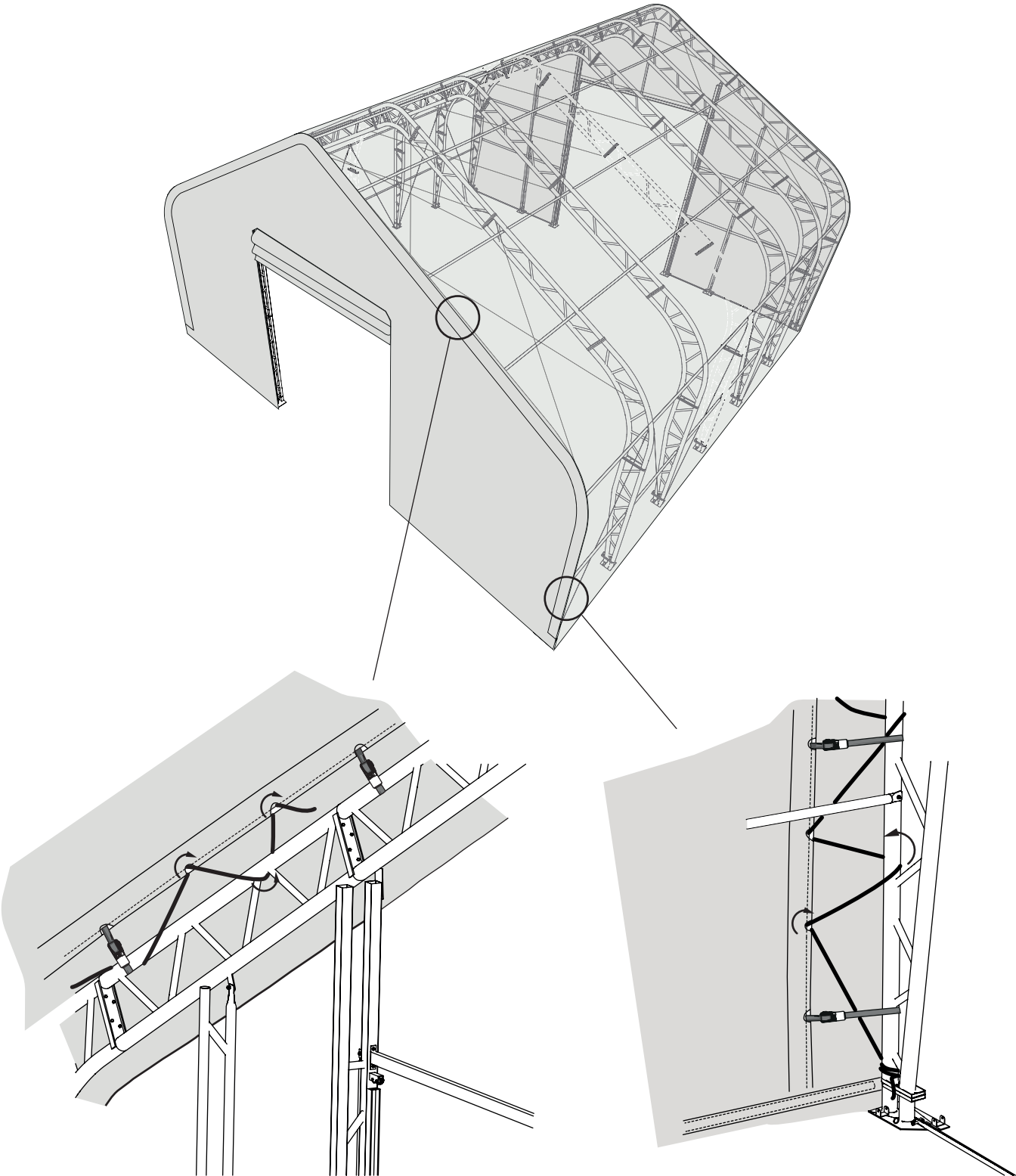
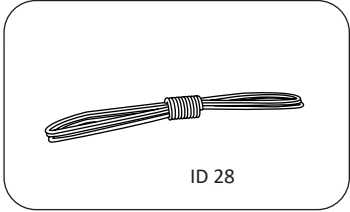

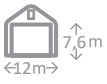

EVEREST 12 m x 12 m, 12 m x 20 m

1 m arch distance

28

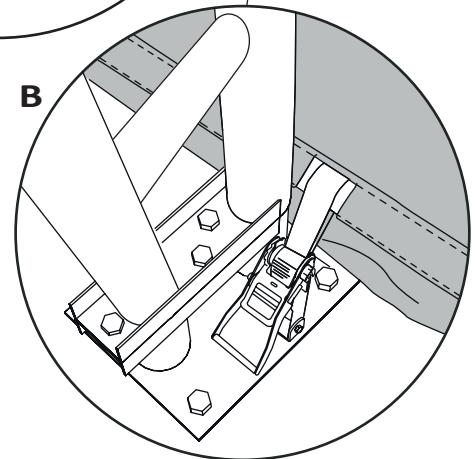
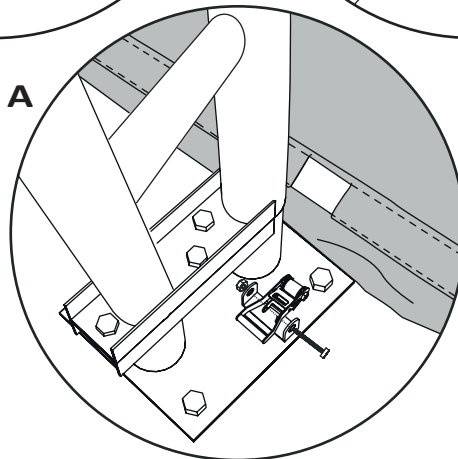
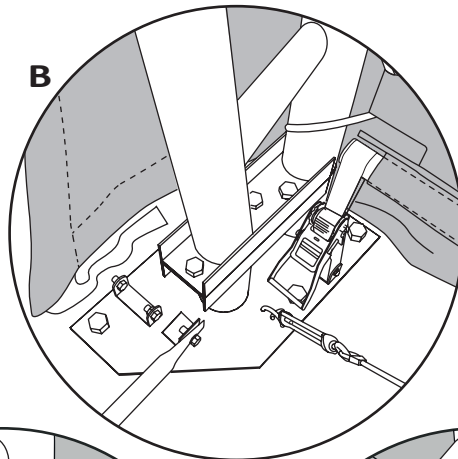
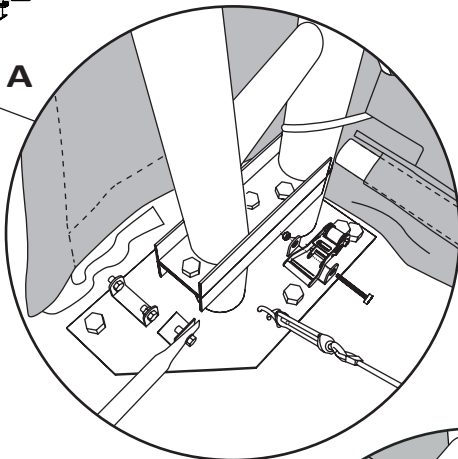
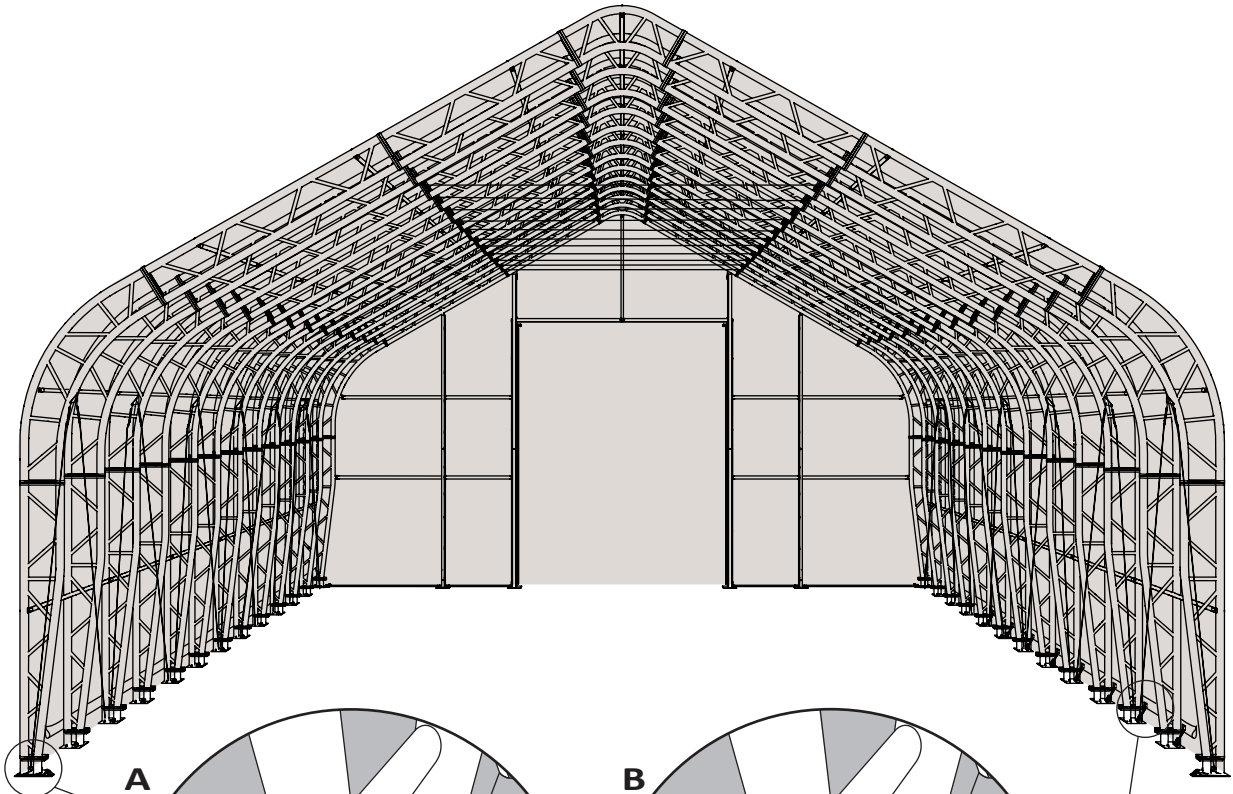
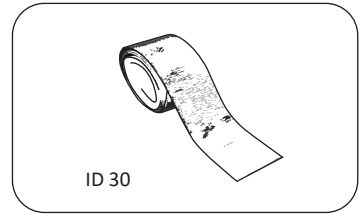
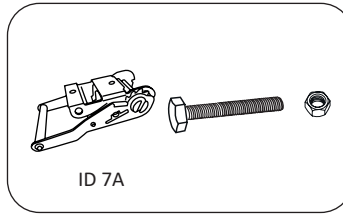

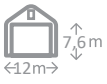

EVEREST 12 m x 12 m, 12 m x 20 m

1 m arch distance

29

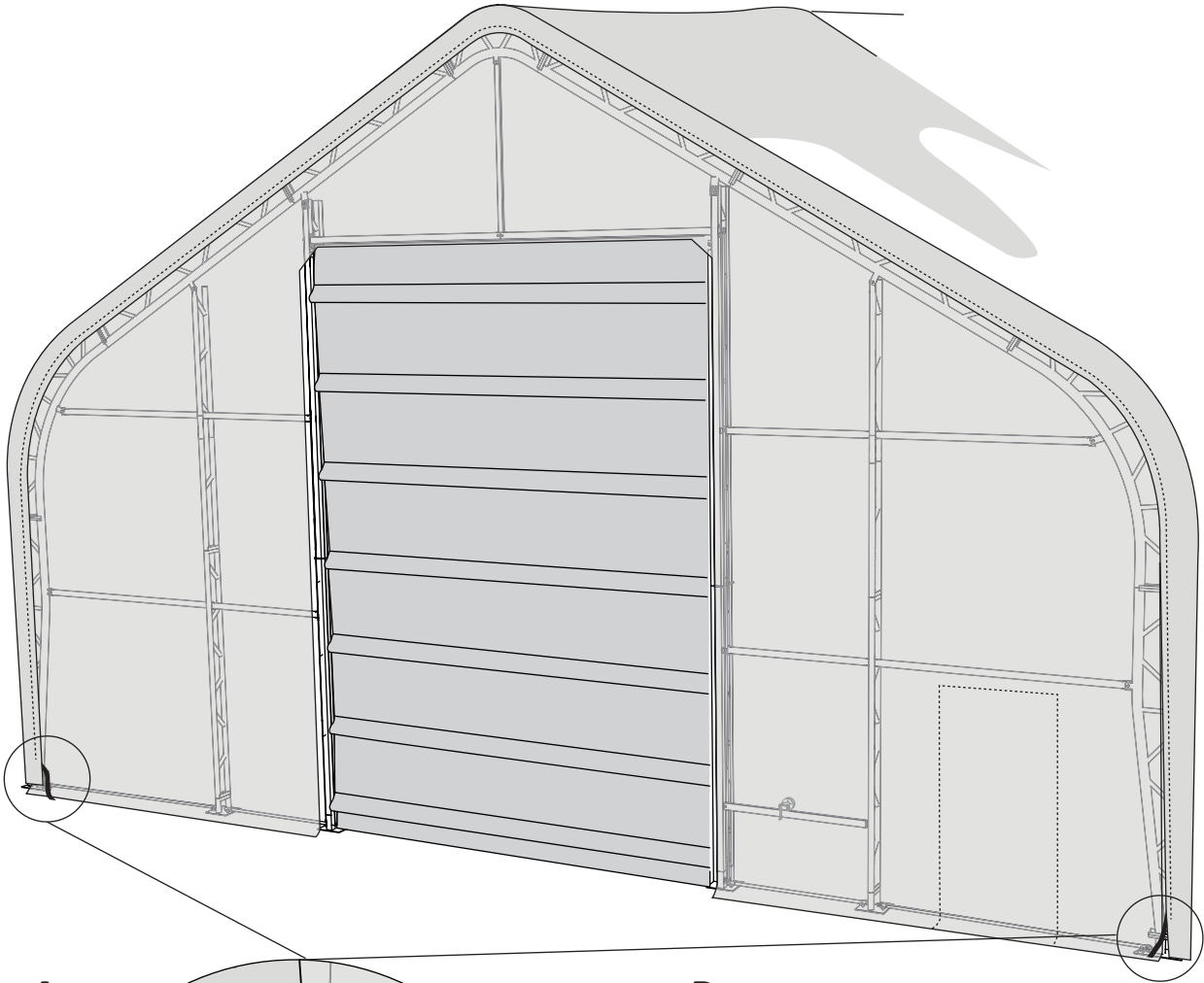
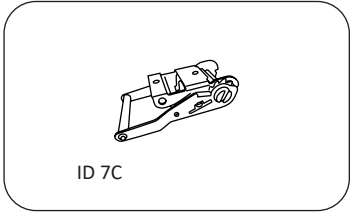

A

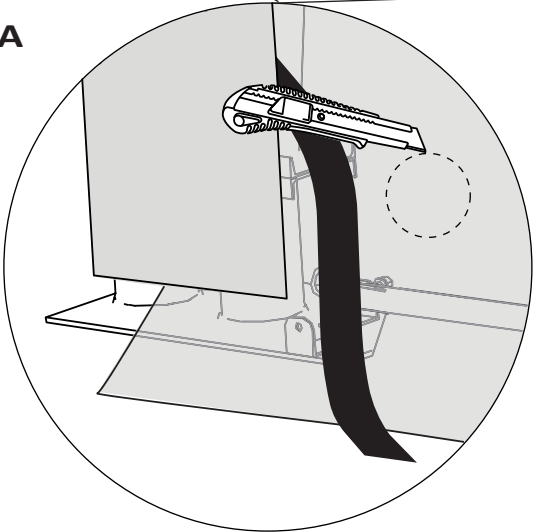

B

