

 **FGWH-L1-Q0 3 m x 4 m**



12/2024-V01

TOOLPORT

A

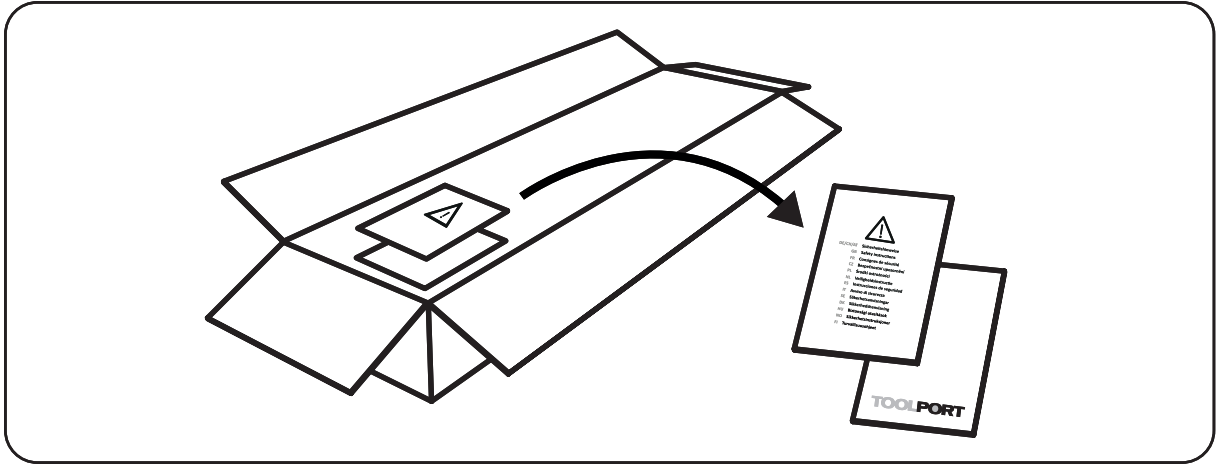

B

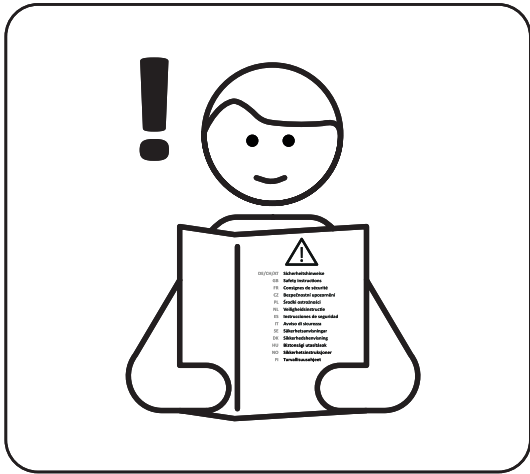



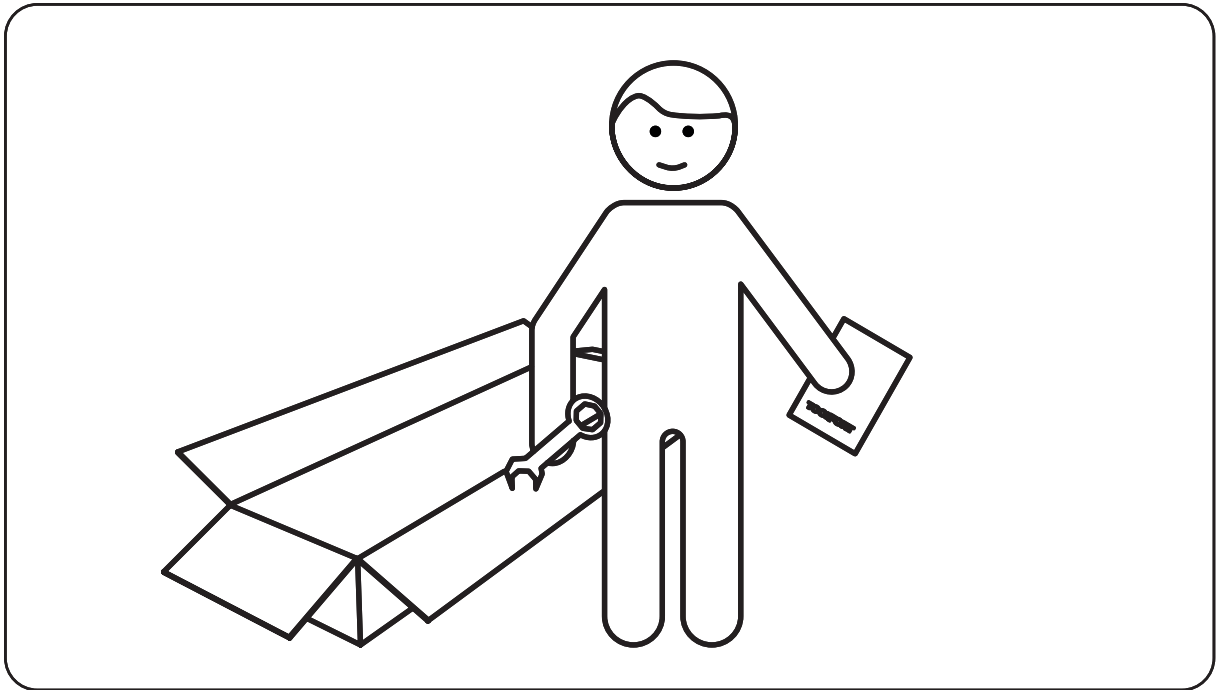

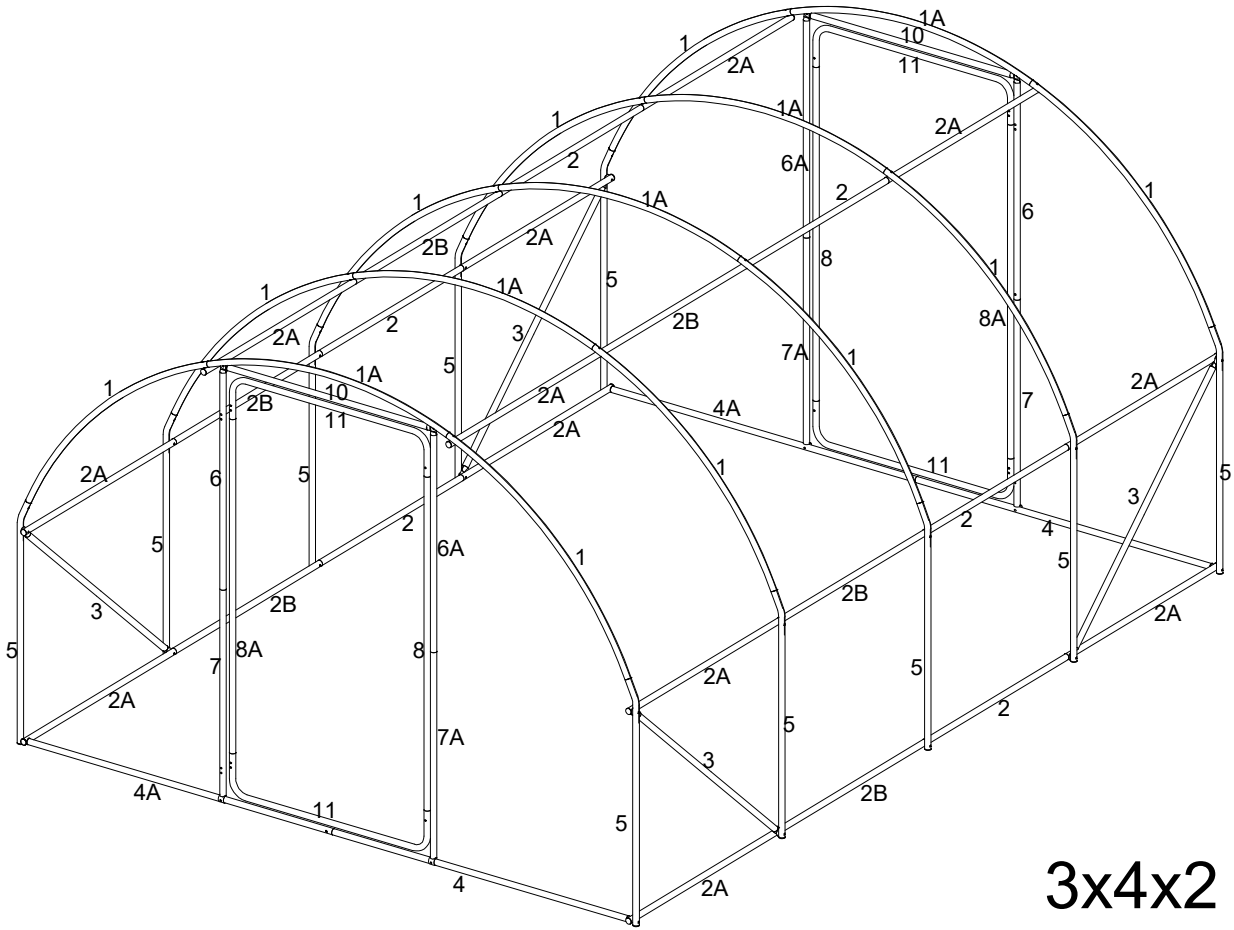





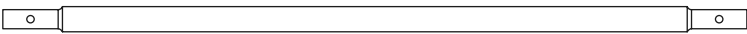

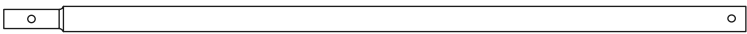
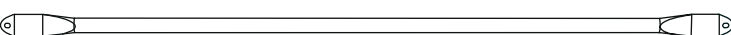

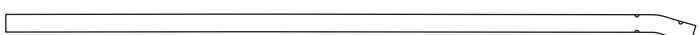

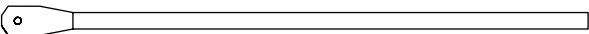
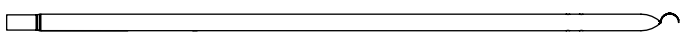
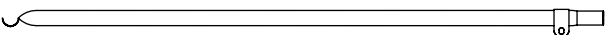

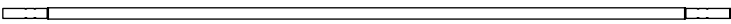
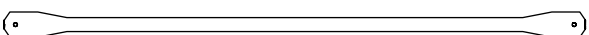

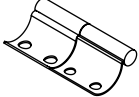

C



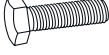

3x4x2

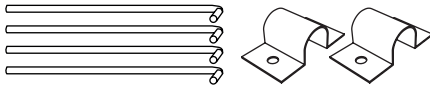
Item no.	ID		Q'ty
710007	1		10
710008	1A		5
710002	2		6
710003	2A		12
710013	2B		6
710040	3		4
710124	4		2
710125	4A		2
710012	5		10
710073	6		2
710074	6A		2
710075	7		2
710076	7A		2
710078	8		2
710077	8A		2
710071	10		2

Item no.	ID		Q'ty
710072	11		4
710085	12		4
710086	13		4
710022	14	M6 	56
35477	15	M6 x 40 mm 	20
710018	16	M6 x 35 mm 	6
710019	17	M6 x 57 mm 	26
33415	18	M6 x 55 mm 	4
710103	19	M6 x 25 mm 	4
33412	20	M6 	2
710045	23		2
-	21		1
-	21		2

