

 **TGWH-L1-Q0** 1 m x 3 m, 1 m x 6 m

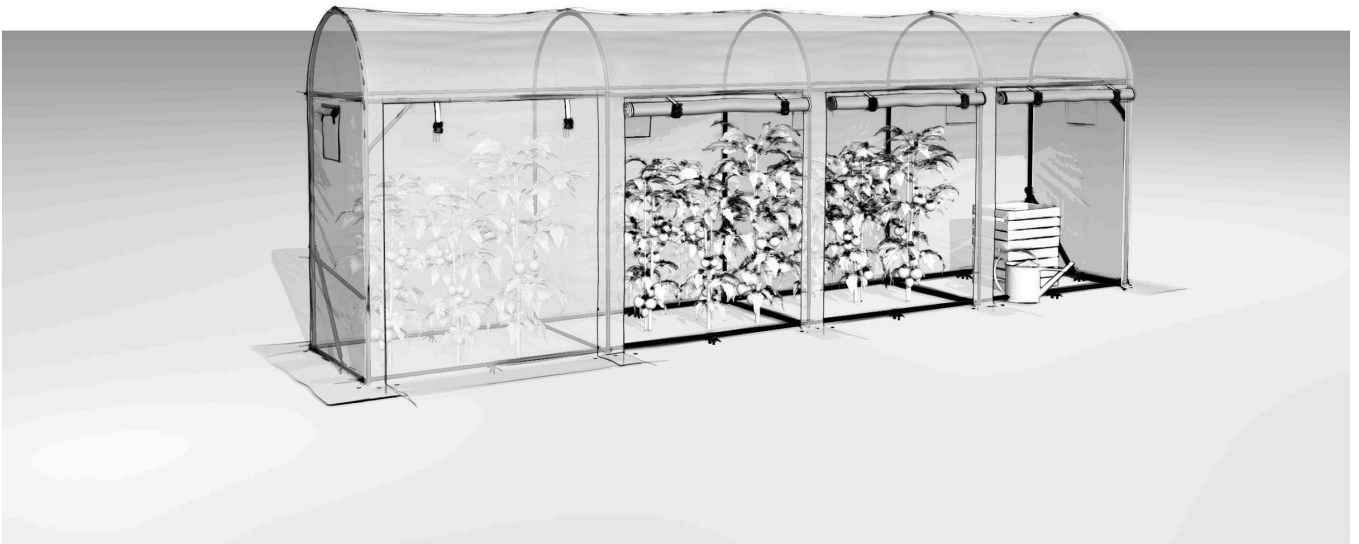

12/2025-V01

# TOOLPORT



 **TGWH-L1-Q0 1 m x 3 m, 1 m x 6 m**

**A**

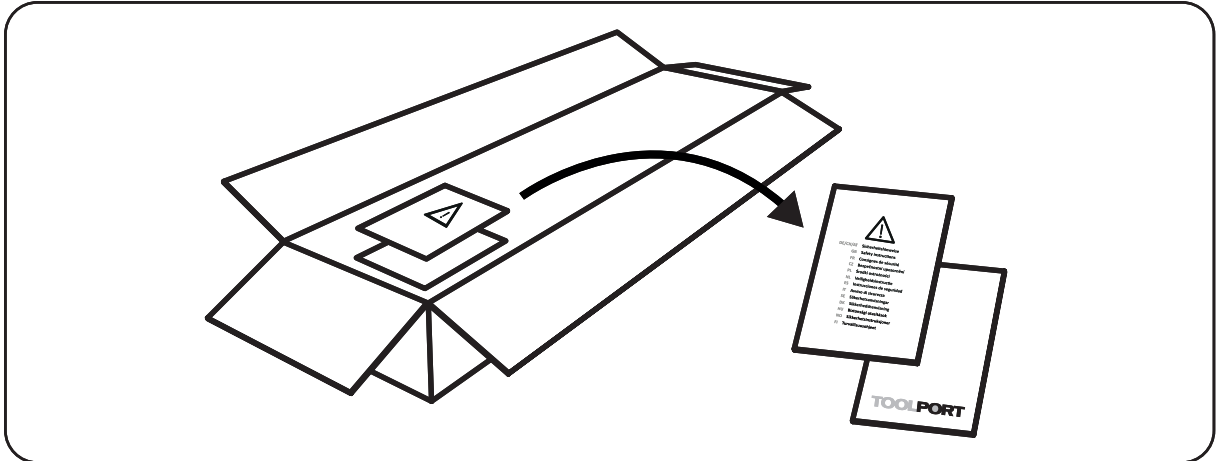



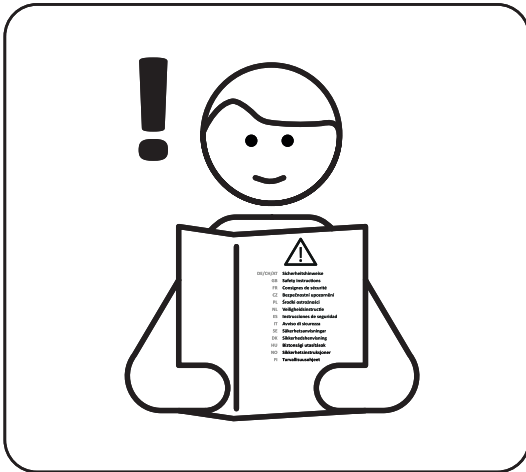

**B**

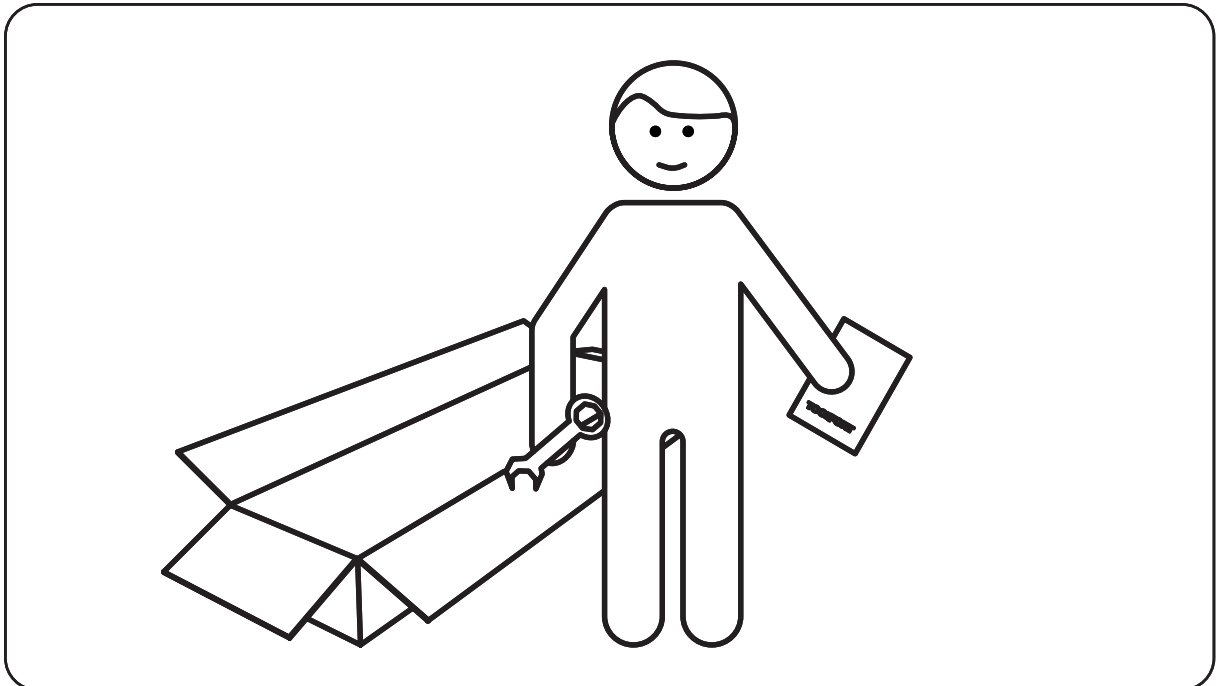





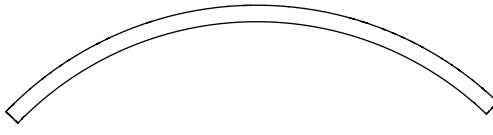
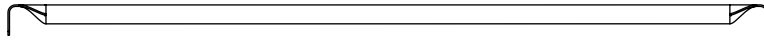
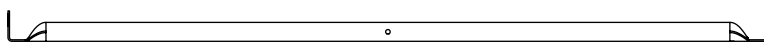
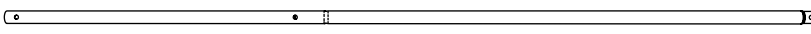
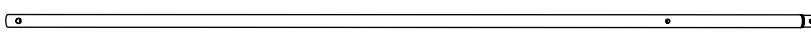
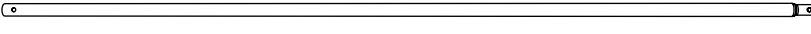
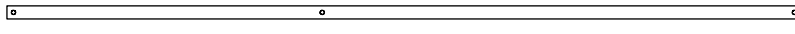
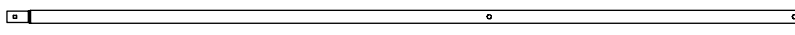
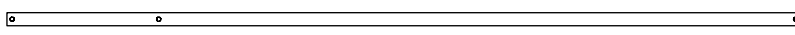
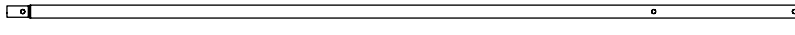
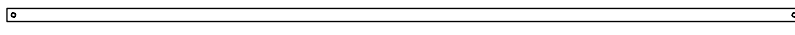
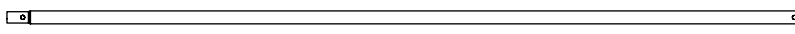
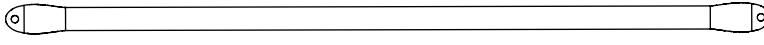



**C**

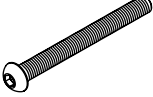

 **TGWH-L1-Q0** 1 m x 3 m, 1 m x 6 m

Item no.	ID		Q'ty 1 x 3	Q'ty 1 x 6
710104	1		3	5
710105	2		3	5
710106	3		3	5
710107	4		2	2
710108	5		2	2
710109	6		2	2
710110	7		2	6
710111	8		1	1
710112	9		1	1
710113	10		1	1
710138	11		1	1
710139	12		2	2
710140	13		2	10
710141	14		4	4
710142	15		2	2

 **TGWH-L1-Q0** 1 m x 3 m, 1 m x 6 m

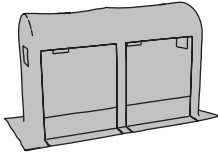
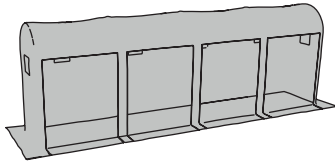
Item no.		Q'ty 1 x 3	Q'ty 1 x 6
35879	 <p>M6</p>	12	20
35282	 <p>M6</p>	12	12
33416		24	32
710022		24	32
30382_E	 <p>M6</p>	1	1
33412	 <p>M6</p>	1	1
710089		22	44
710090		6	12
	 	1	1

 **TGWH-L1-Q0** 1 m x 3 m, 1 m x 6 m

1

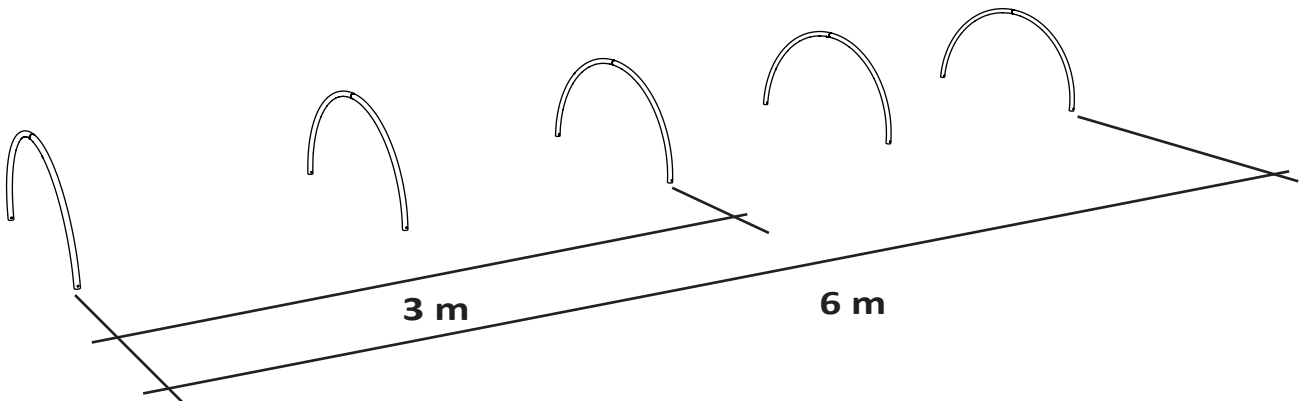
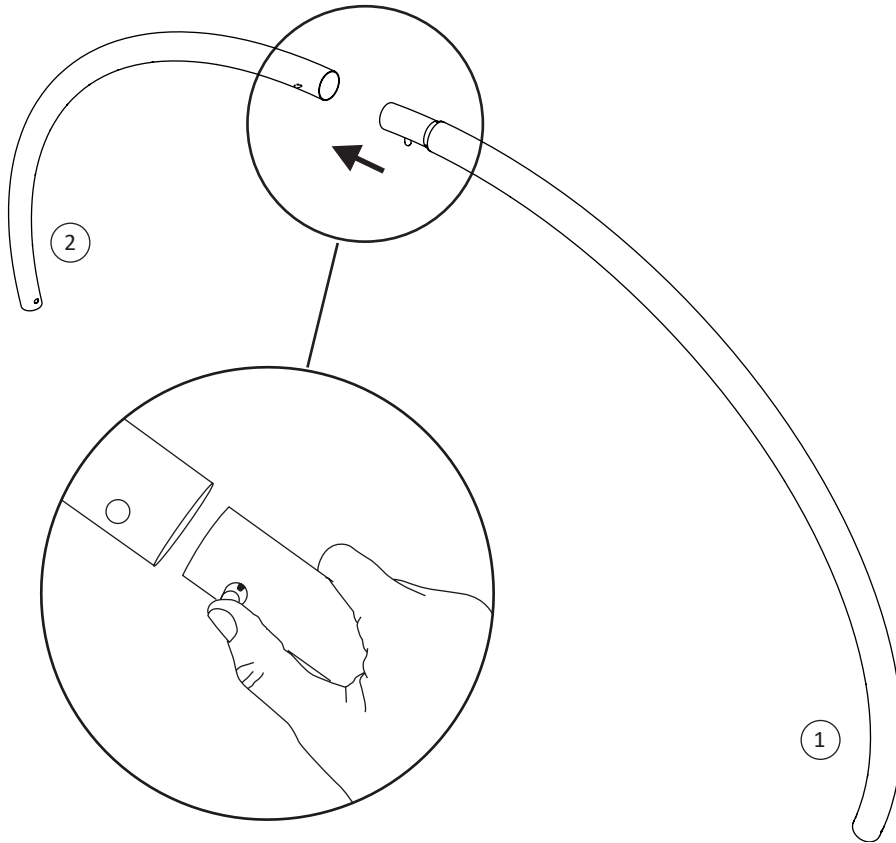
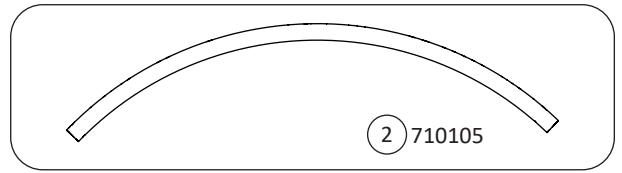
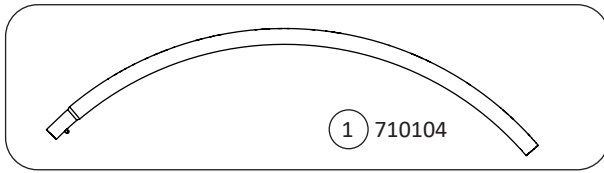

 **TGWH-L1-Q0** 1 m x 3 m, 1 m x 6 m

2

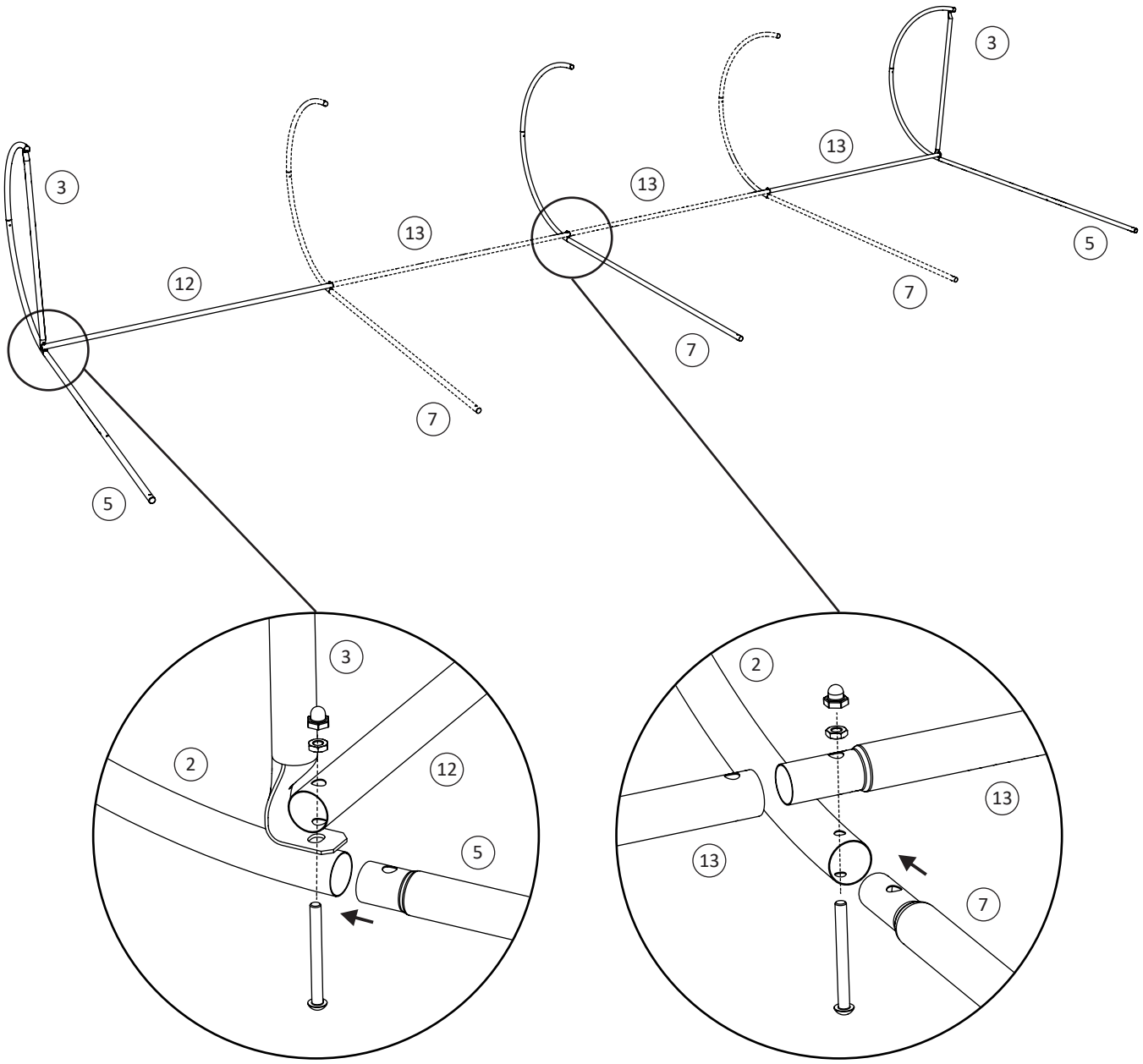
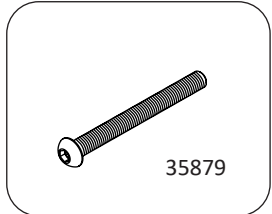
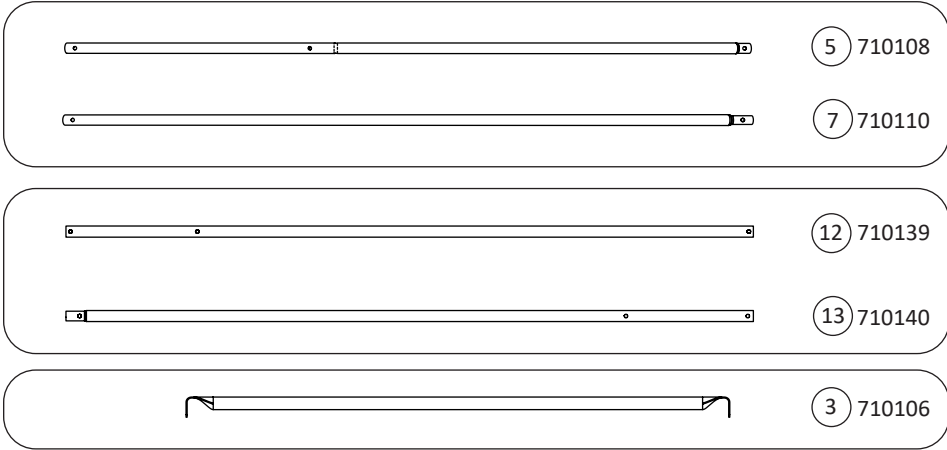

 **TGWH-L1-Q0** 1 m x 3 m, 1 m x 6 m

3

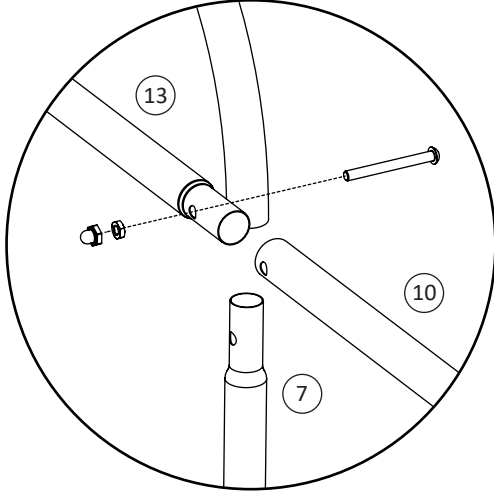
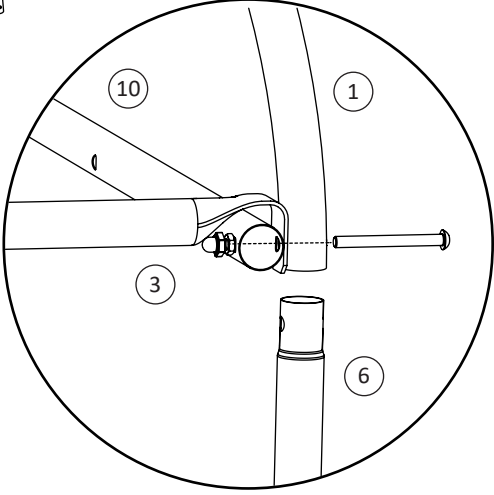
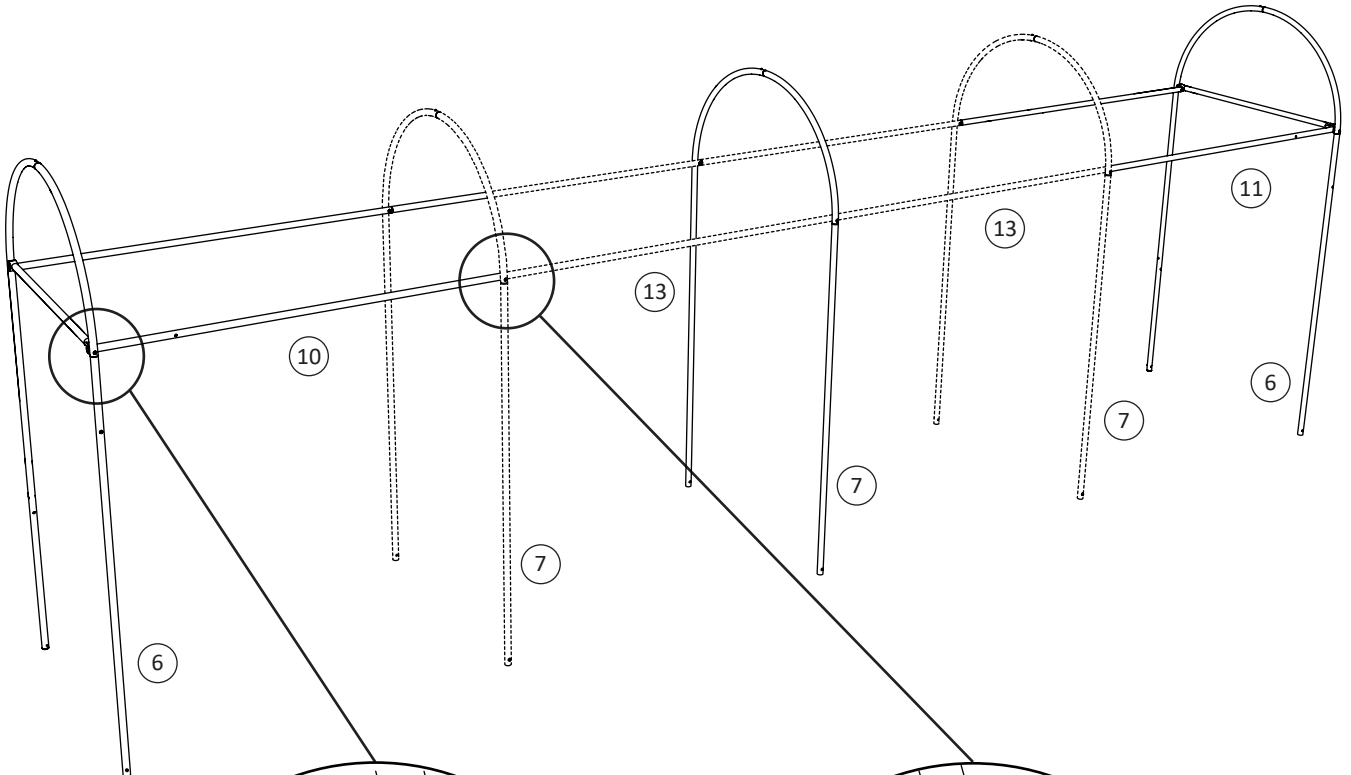
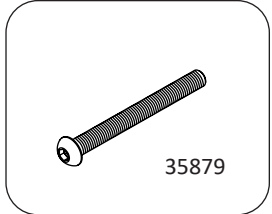
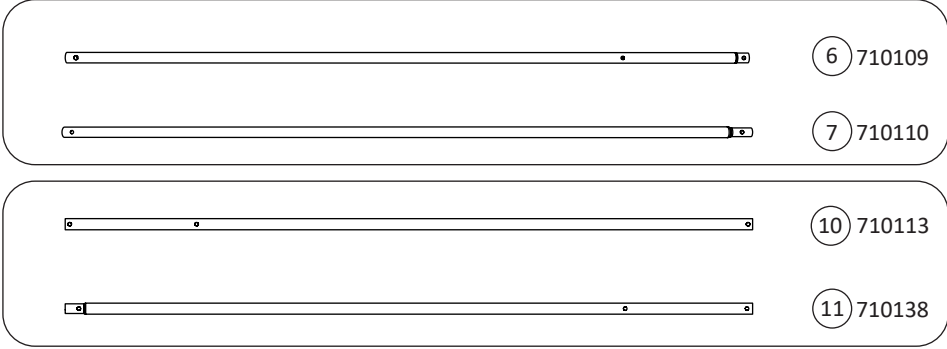

 **TGWH-L1-Q0** 1 m x 3 m, 1 m x 6 m

4

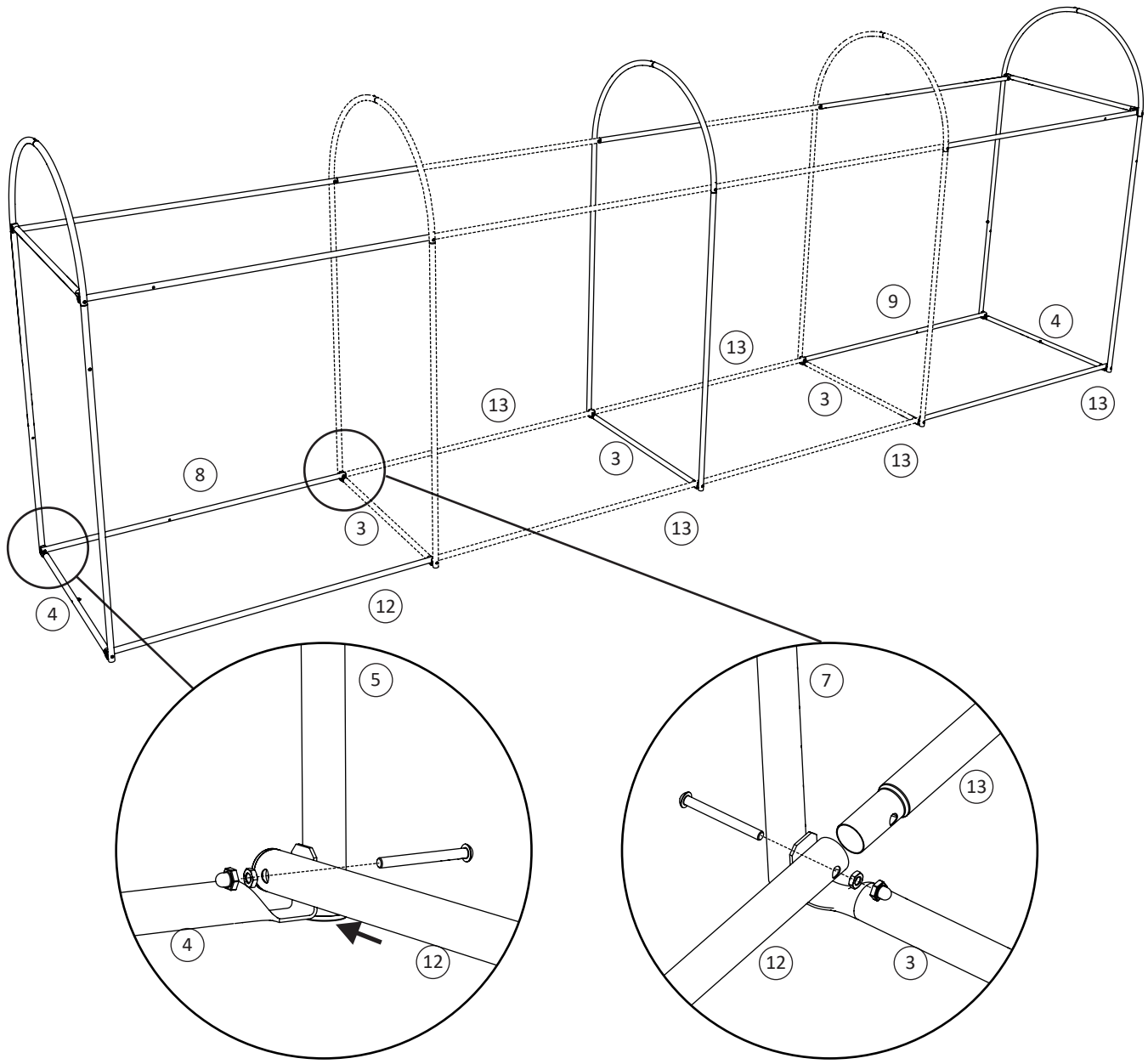
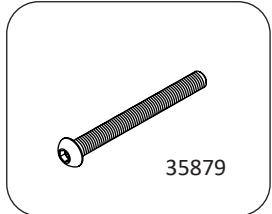
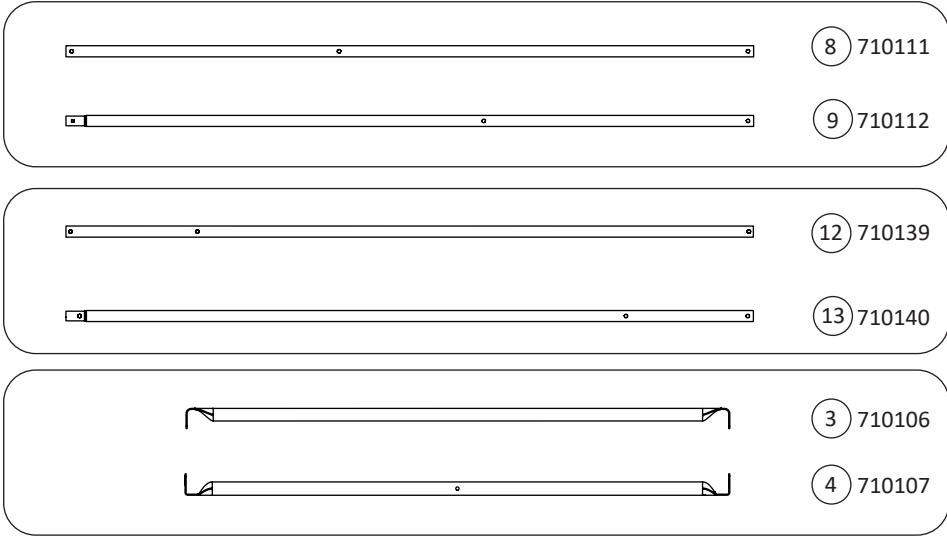

 **TGWH-L1-Q0** 1 m x 3 m, 1 m x 6 m

5

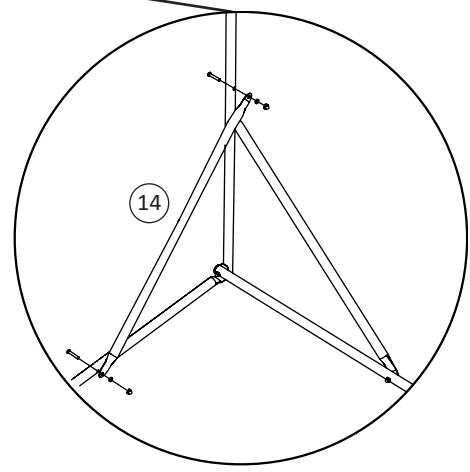
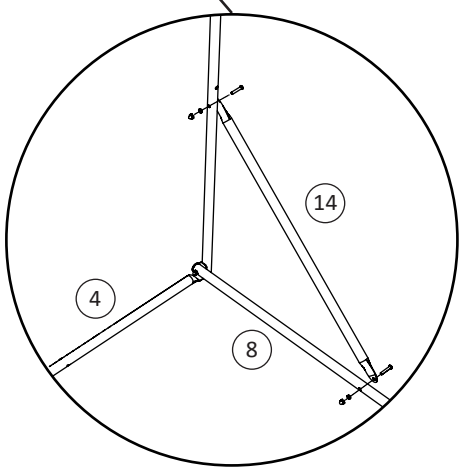
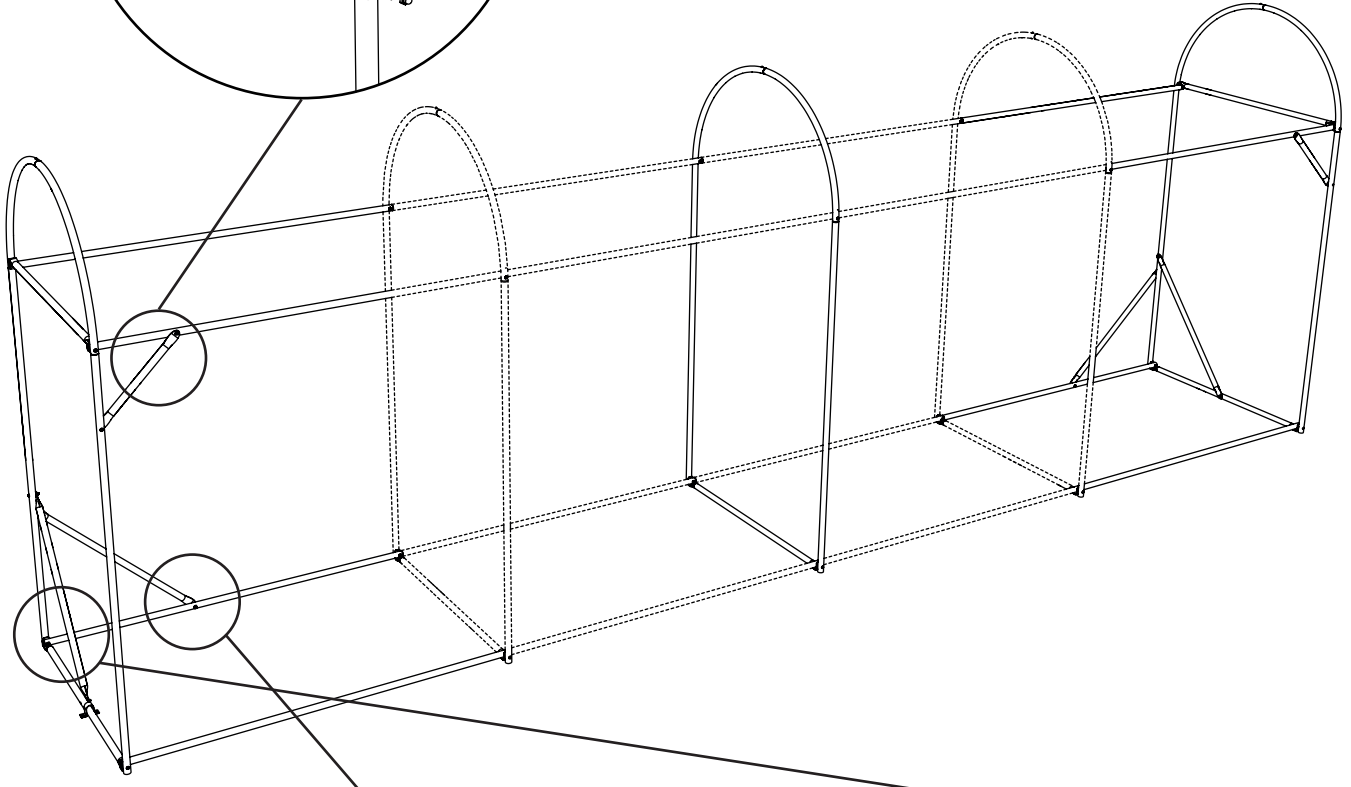
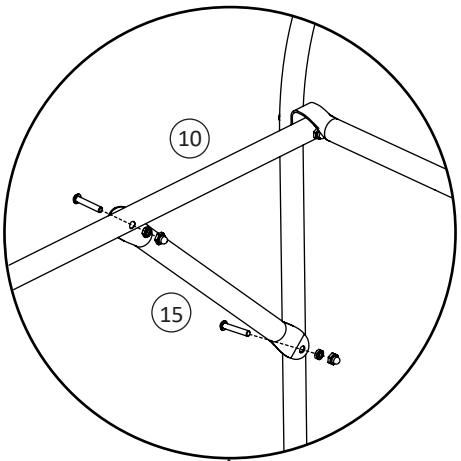
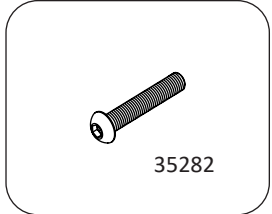
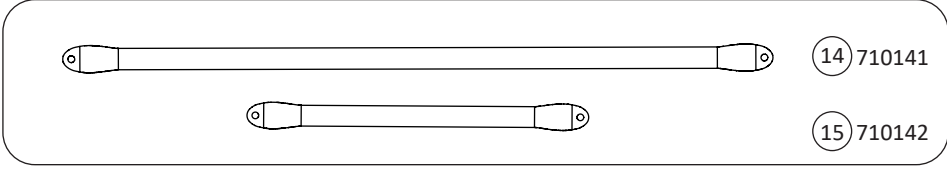

 **TGWH-L1-Q0** 1 m x 3 m, 1 m x 6 m

6

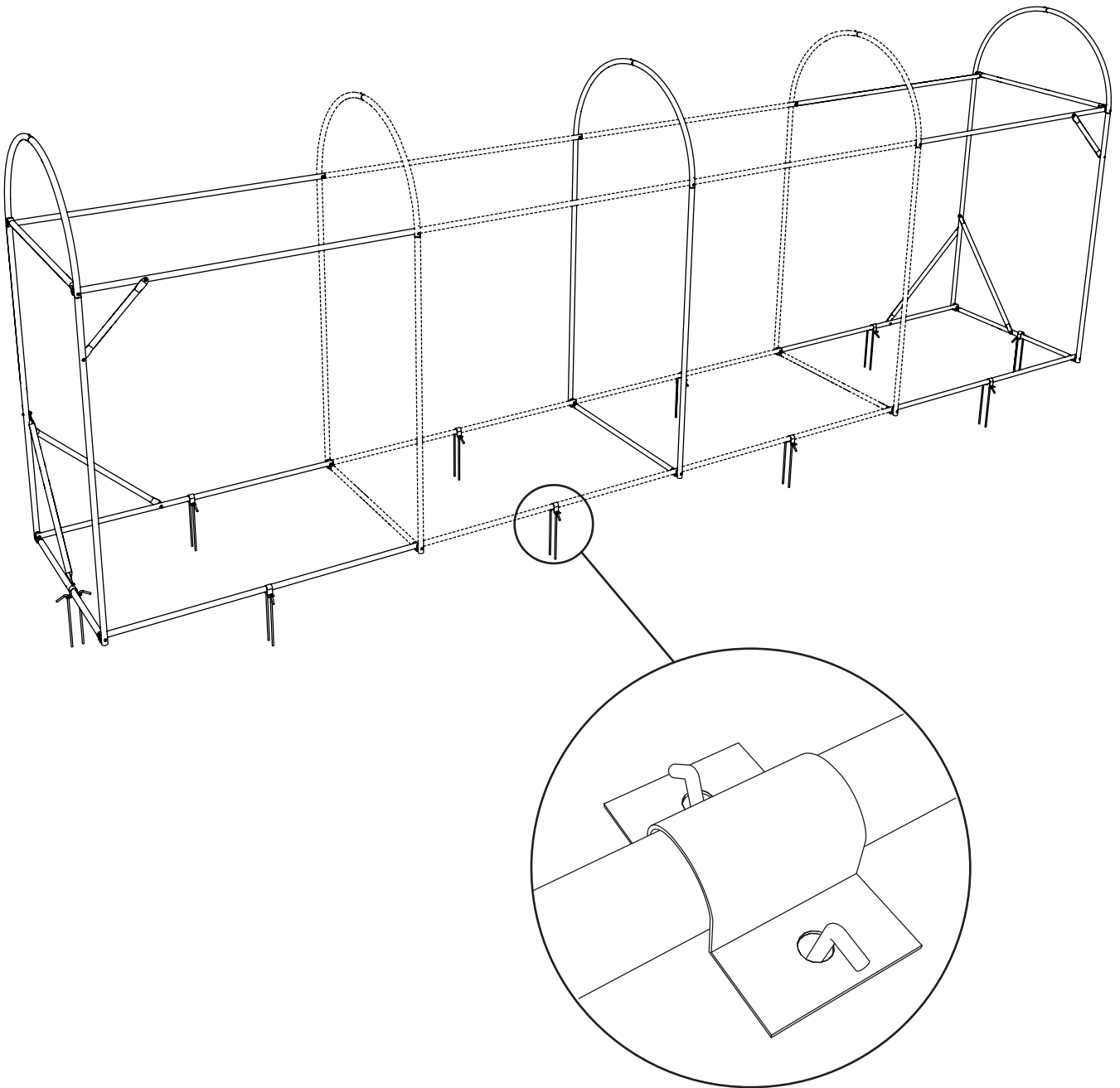
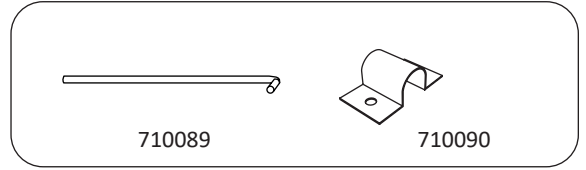

 **TGWH-L1-Q0** 1 m x 3 m, 1 m x 6 m

7

