

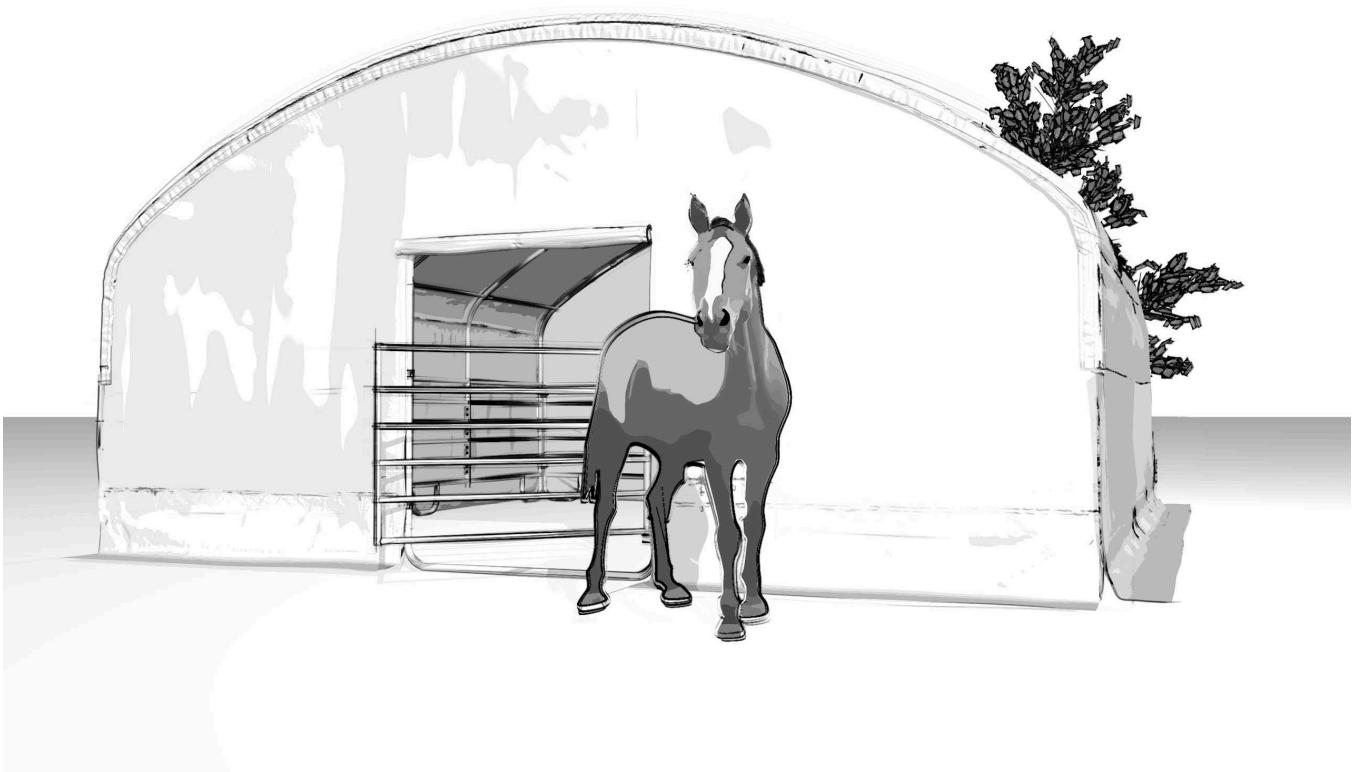

WZ-L3-Q1 8 m x 8 m Front wall



02/2024-V01

TOOLPORT



WZ-L3-Q1 8 m x 8 m Front wall

A

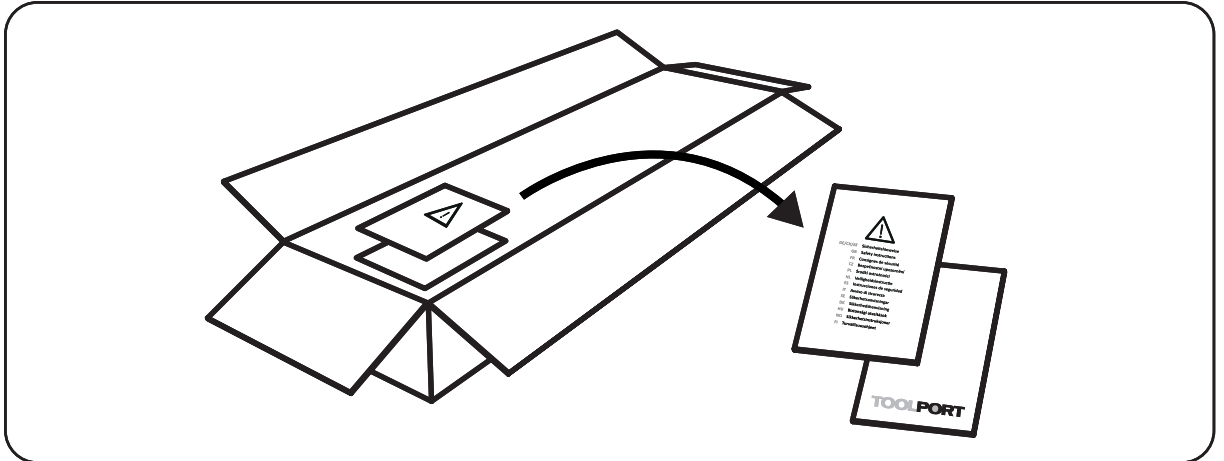

B

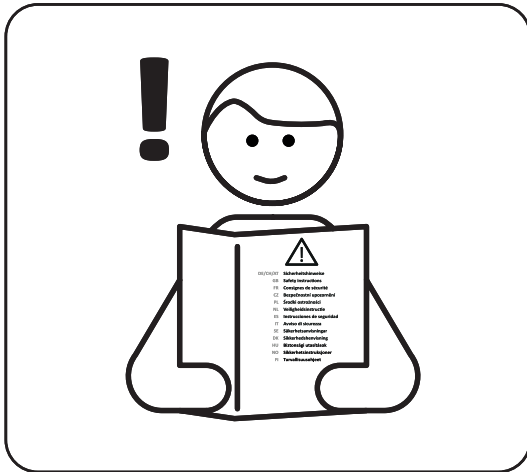



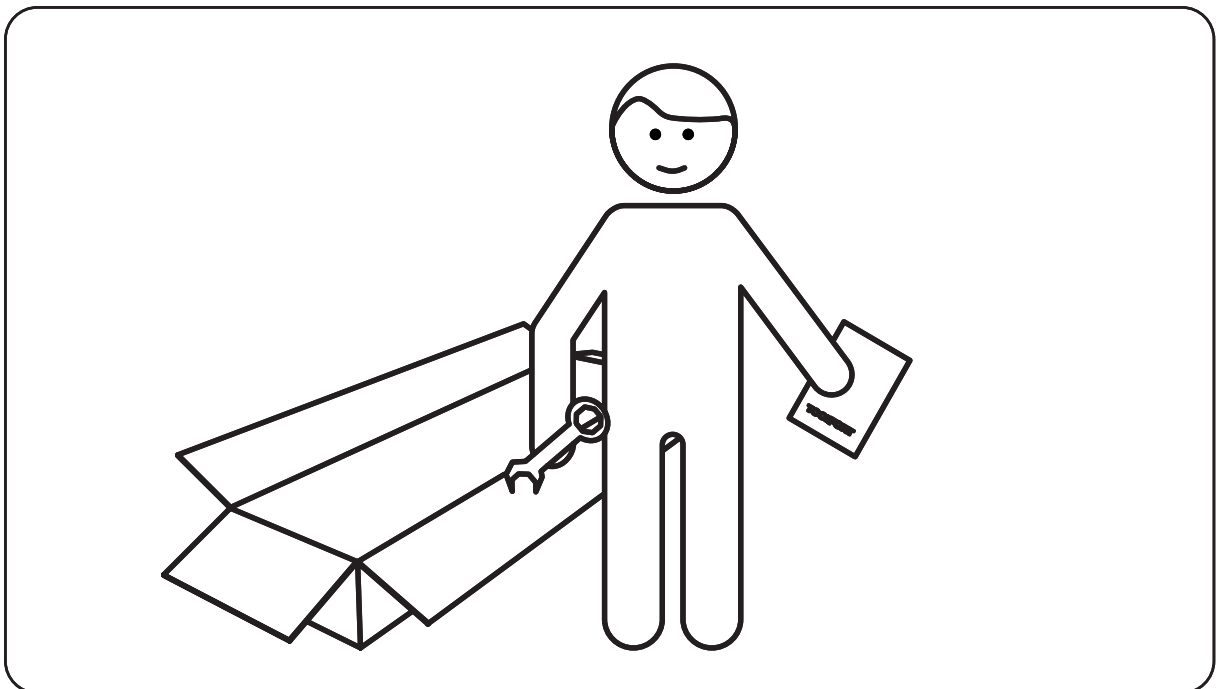







C

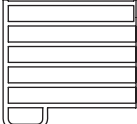

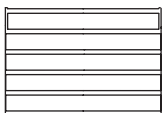

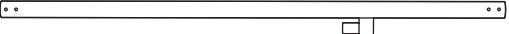
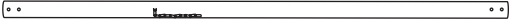









WZ-L3-Q1 8 m x 8 m Front wall

Item no.	ID		Q'ty
36574	6		2 Sets/ 4 Pieces
36513	7		1
36575	8		4
36531	8	 (optional accessories)	8
36594	8A	 (optional accessories)	4
36578	11		2
36579	12		2
36580	13		1
36581	14		1
36582	15		1
36583	16		1
36584	17		1
36559	18		4



WZ-L3-Q1 8 m x 8 m Front wall

Item no.	ID		Q'ty
36521	19		1
36585	20		4
36586	21		4
36524	23	M8 70 mm 	8
36588	24	M12 25 mm 	20
36589	25		8
36591	27		1
36592	29		4
36529	30	M8 	8
36593	32	M12 	20
36530	33		1



WZ-L3-Q1 8 m x 8 m Front wall

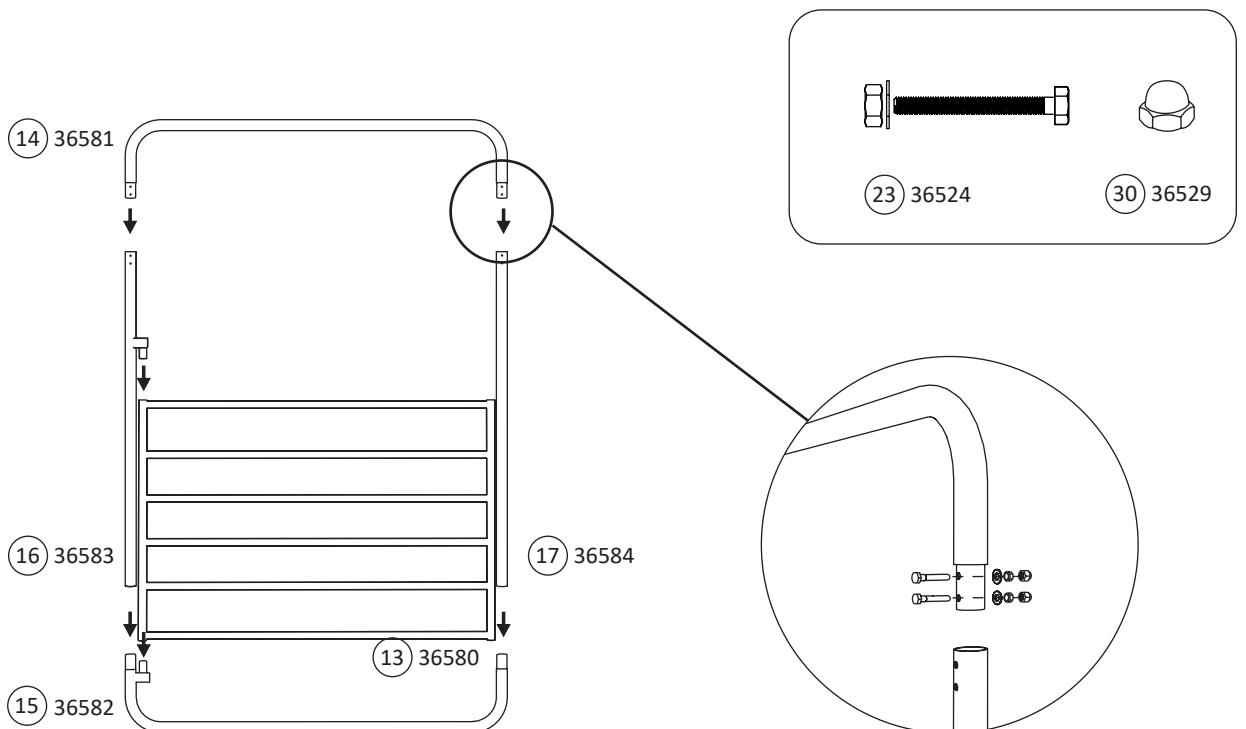
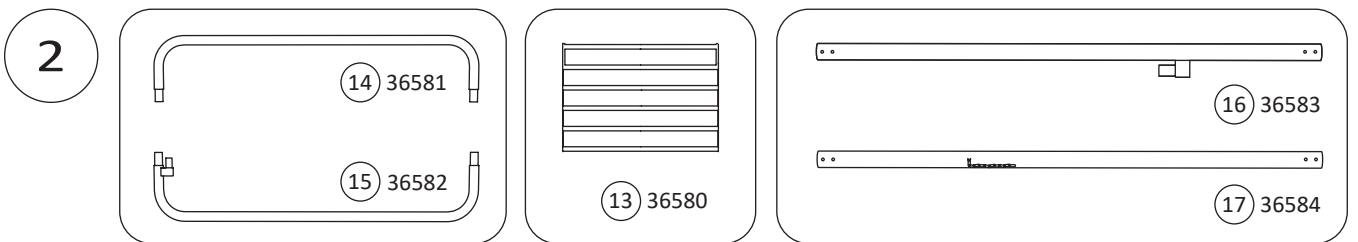
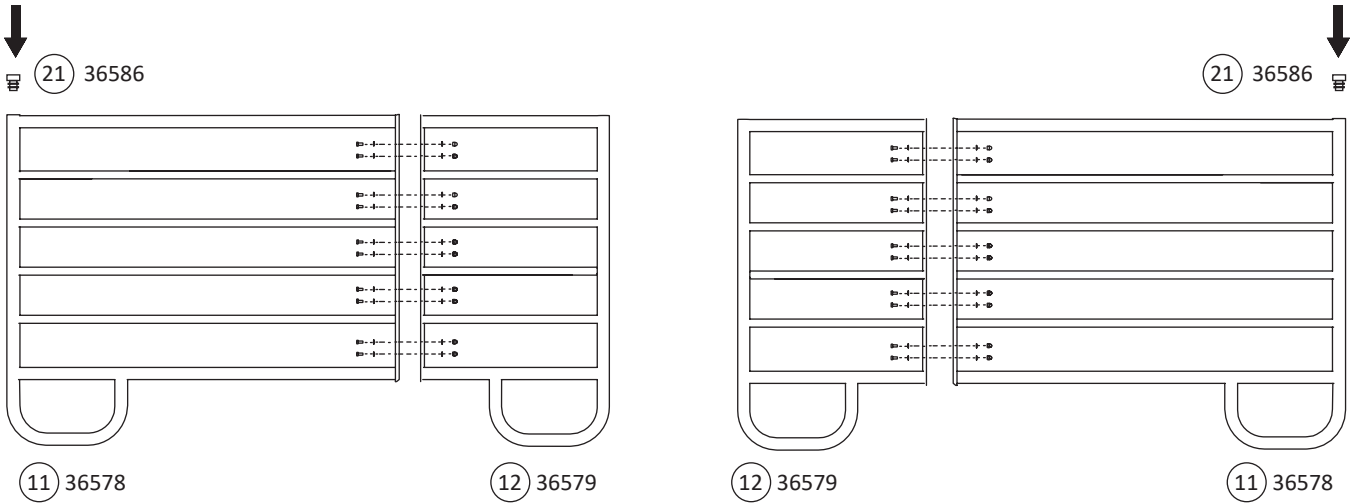
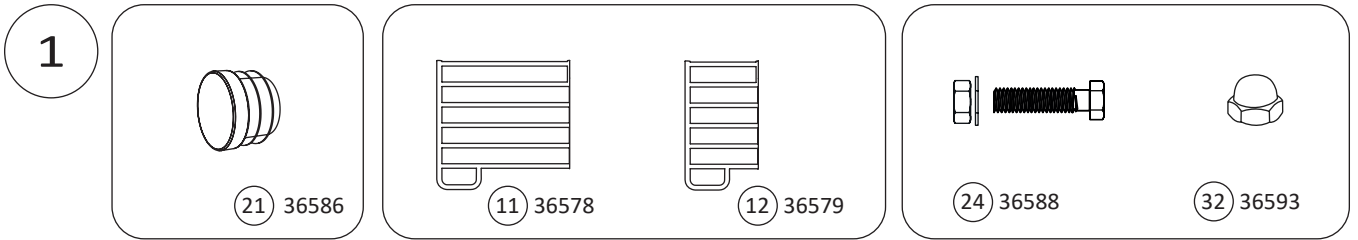



WZ-L3-Q1 8 m x 8 m Front wall

3

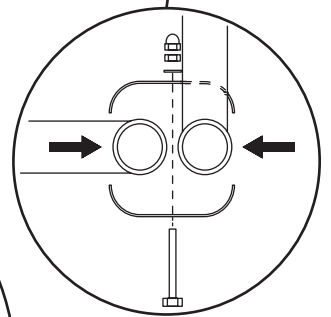
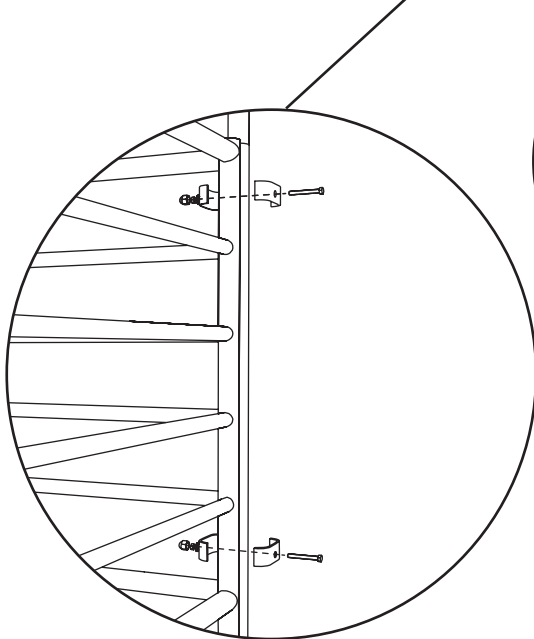
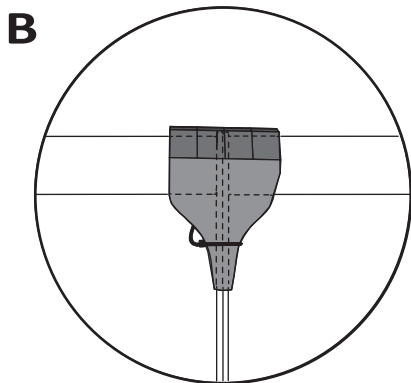
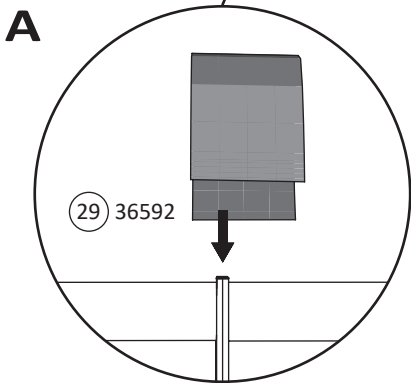
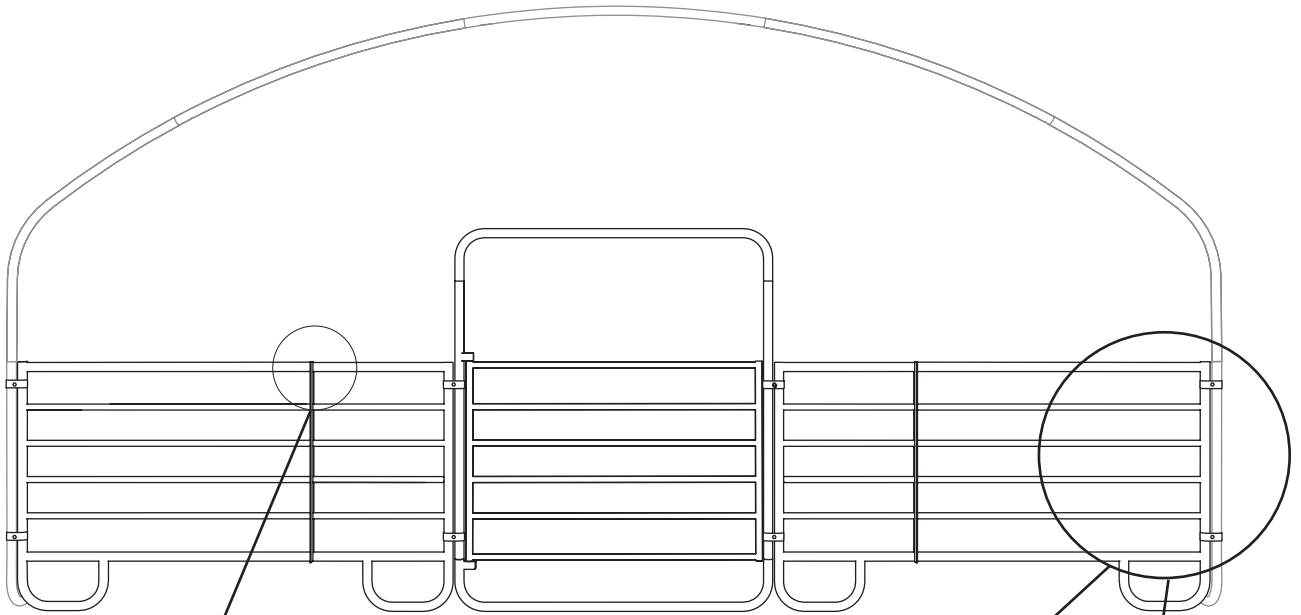
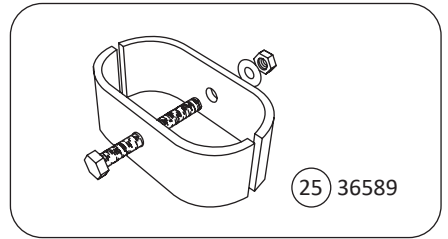
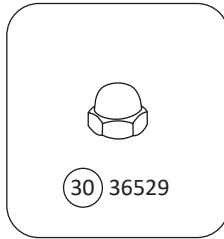
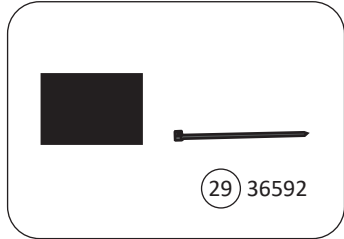



WZ-L3-Q1 8 m x 8 m Front wall

4



8A 36594

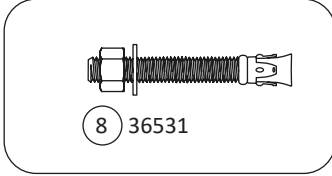

8 36531

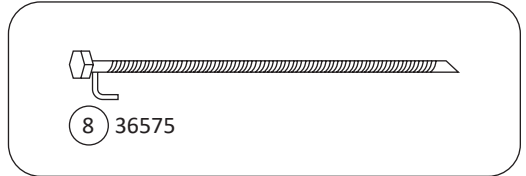

8 36575

! optional accessories

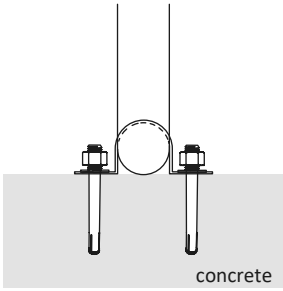

concrete

- DE - Bodenanker
- GB - Ground anchor
- PL - kotwica ziemia
- NL - Vloerverankerung
- FR - ancrage au sol
- CS - zemní kotva
- ES - ancla de tierra
- IT - ancoraggio
- SE - jordankare
- DK - Betonanker
- HU - földi horgony
- FI - Maa-ankkuri
- DK - Jordanker

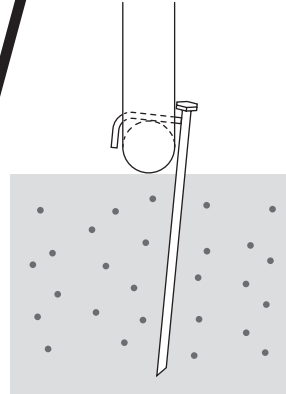

- DE - Erdnagel
- GB - tent stakes
- PL - Szpilki
- NL - grondankers
- FR - Grands piquets
- CS - věšák
- ES - Clavos de tierra
- IT - piolo
- SE - jordspik
- DK - Jordspyd
- HU - Föld szög
- FI - Maan naula
- DK - Jordsøm

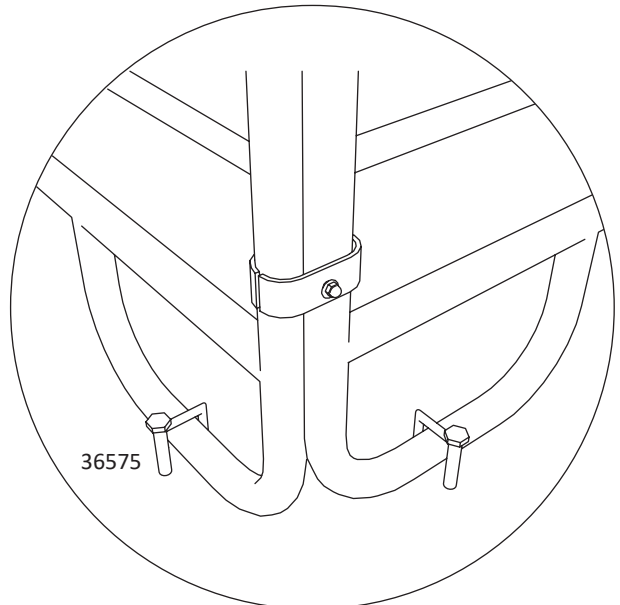
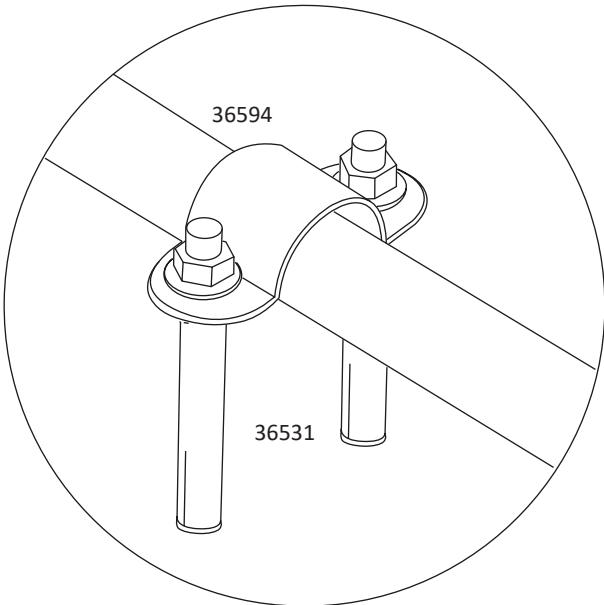



WZ-L3-Q1 8 m x 8 m Front wall

5

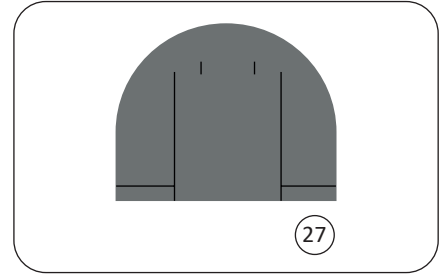
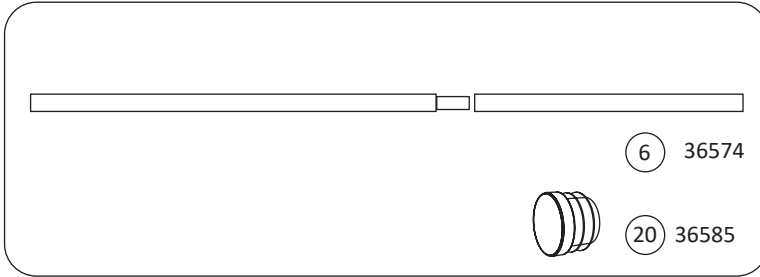

2x

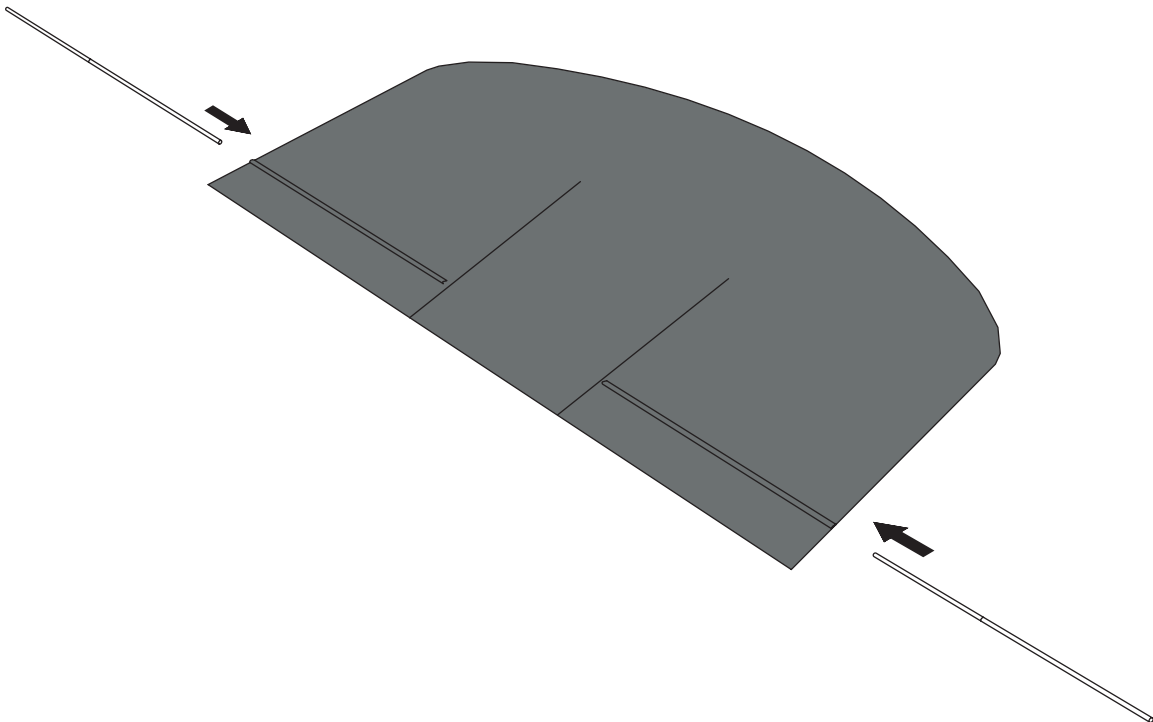
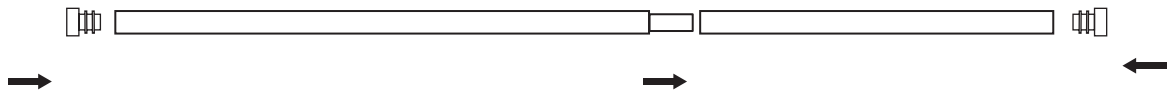



WZ-L3-Q1 8 m x 8 m Front wall

6

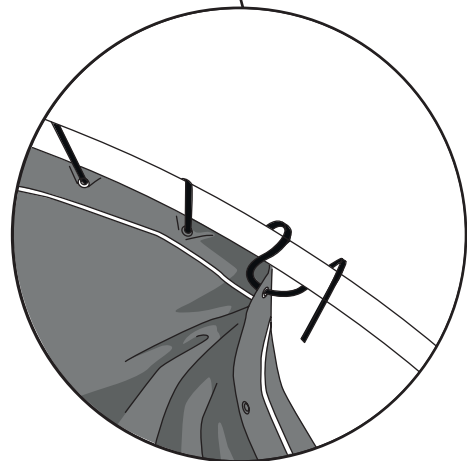
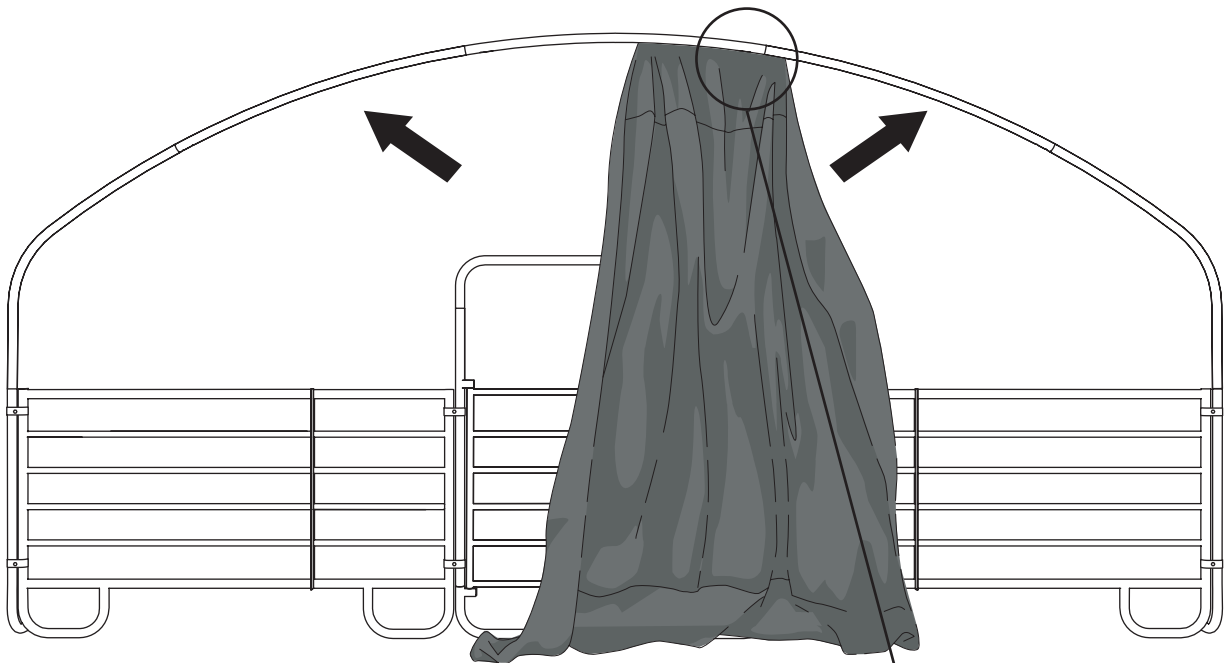
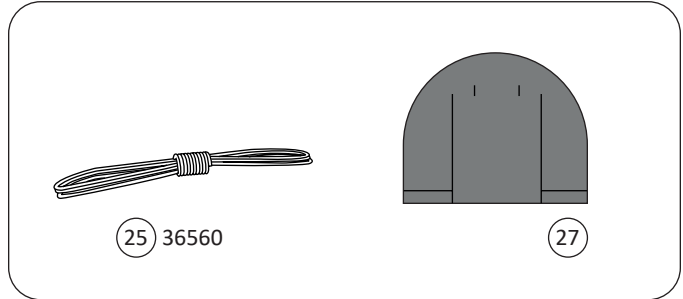



WZ-L3-Q1 8 m x 8 m Front wall

7

